

**User manual**  
**NFD-3090-EIS-IOLM\W**  
**netFIELD IO-Link Wireless Master EtherNet/IP Adapter**  
**V1.4**



**Hilscher Gesellschaft für Systemautomation mbH**  
**[www.hilscher.com](http://www.hilscher.com)**

DOC200701UM04EN | Revision 4 | English | 2024-07 | Released | Pubic

# Table of contents

<b>1</b>	<b>Introduction</b>	<b>5</b>
1.1	About this document	5
1.2	List of revisions	5
1.3	Product software	5
<b>2</b>	<b>Device description</b>	<b>6</b>
2.1	Functional description	6
2.2	Device overview	7
2.3	Revisions and versions	9
2.3.1	Compatibility notes	9
2.4	Identification	10
2.5	Connectors and interfaces	11
2.5.1	Power supply	11
2.5.2	Ethernet	11
2.5.3	IO-Link, SMA antenna	12
2.6	Derating	12
<b>3</b>	<b>Safety</b>	<b>13</b>
3.1	General note	13
3.2	Intended use	13
3.3	Personnel qualification	13
3.4	Power drop during write and delete accesses in the file system	14
3.5	Exceeding the maximum number of permitted write and delete accesses	14
3.6	Information and data security	14
<b>4</b>	<b>Getting started</b>	<b>15</b>
<b>5</b>	<b>Requirements</b>	<b>16</b>
5.1	Hardware and system requirements	16
5.2	Software requirements	16
<b>6</b>	<b>Mounting and demounting</b>	<b>17</b>
6.1	Mounting	17
6.1.1	Grounding	19
6.2	Demounting	19
6.3	Disposal and recycling of waste electronic equipment	20
<b>7</b>	<b>Connections</b>	<b>21</b>
7.1	Connection example	22
<b>8</b>	<b>Configuration</b>	<b>23</b>
8.1	Configuration tools	23
8.2	Configuring EtherNet/IP	26
8.2.1	Selecting a connection	27
8.2.2	Setting parameters	28
8.3	Configuration with netFIELD Wireless Web Server	33
8.3.1	Functional overview	34

8.3.2	Open netFIELD Wireless Web Server .....	35
8.3.3	Dashboard .....	36
8.3.4	Log in and user administration.....	37
8.3.5	Device settings.....	39
8.3.6	IO-Link Wireless Master settings .....	50
8.3.7	Port specific information and settings .....	59
<b>9</b>	<b>Commissioning .....</b>	<b>80</b>
9.1	Getting an IP address from a DHCP server .....	80
9.2	Configuration with netFIELD Wireless Web Server .....	81
9.2.1	Configuring the IO-Link Wireless Master .....	82
9.2.2	Port settings for commissioning .....	84
9.3	Testing .....	88
9.4	Master reset .....	90
9.5	Indexed Service Data Units.....	91
9.6	Wireless .....	92
9.7	Setting date and time .....	92
9.8	Using OPC UA Client.....	93
9.8.1	Connecting with device .....	93
9.8.2	Setting date and time of the device via OPC UA .....	95
<b>10</b>	<b>Communication.....</b>	<b>97</b>
10.1	Process data .....	97
10.1.1	Connections 1 to 4 .....	98
10.1.2	Connections 5 to 7 .....	101
10.1.3	Connections 8 to 10 .....	105
10.1.4	Input process data status.....	109
10.2	OPC UA .....	110
10.2.1	Device identification .....	111
10.2.2	Identification of connected IO-Link Devices.....	111
10.2.3	NTP Client configuration .....	112
10.3	MQTT topics.....	113
10.3.1	General parts of a topic.....	113
10.3.2	Gateway topics .....	113
10.3.3	Master topics.....	115
10.3.4	Device topics.....	120
10.3.5	MQTT topics .....	124
<b>11</b>	<b>Diagnosis.....</b>	<b>125</b>
11.1	Diagnosis via LEDs .....	125
11.1.1	System LED .....	125
11.1.2	APL LED .....	126
11.1.3	Supply voltage status.....	126
11.1.4	EtherNet/IP Adapter status .....	127
11.1.5	Wireless track status.....	129
11.1.6	Wireless port status .....	129
11.2	Diagnosis via EtherNet/IP .....	130
11.2.1	Event Log Object 65 (0x41) .....	130
11.2.2	CIP status .....	132
11.3	Diagnosis over IO-Link.....	135
11.3.1	Event Qualifier .....	135
11.3.2	IO-Link Wireless Master Event Codes .....	135

---

11.3.3 IO-Link Device Event Codes (common).....	136
<b>12 Technical data.....</b>	<b>138</b>
12.1 Technical data device .....	138
12.2 Technical data IO-Link Wireless Master .....	140
12.3 Technical data protocol .....	141
12.4 Technical data netFIELD Wireless Web Server.....	142
12.5 OPC UA Server.....	142
12.6 MQTT Client.....	142
<b>13 Dimensions.....</b>	<b>143</b>
13.1 Dimensions netFIELD IO-Link Wireless Master device .....	143
<b>14 Approvals .....</b>	<b>144</b>
14.1 FCC/ISED .....	144
<b>15 Appendix.....</b>	<b>146</b>
15.1 References.....	146
15.2 Conventions in this manual .....	147
15.3 Directives and standards.....	148
15.4 Legal notes.....	149
15.5 Registered trademarks.....	153
<b>Glossary.....</b>	<b>159</b>
<b>Contacts.....</b>	<b>162</b>

# 1 Introduction

## 1.1 About this document

This document describes the netFIELD IO-Link Wireless Master EtherNet/IP Adapter **NFD-3090-EIS-IOLM/W** device.

## 1.2 List of revisions

Index	Date	Revision
3	2022-02-25	<p>Product released.</p> <p><i>Description:</i> Section <i>Revisions and versions</i> [▶ page 9] and section <i>Identification</i> [▶ page 10] updated.</p> <p><i>Connections:</i> Section <i>Connection example</i> [▶ page 22] updated.</p> <p><i>Configuration:</i> Section <i>Configuration with netFIELD Wireless Web Server</i> [▶ page 33] description updated (subsections <i>Pairing</i> [▶ page 69] and <i>W-Bridge Update</i> [▶ page 71] added, and further updates).</p> <p><i>Communication:</i> Section <i>OPC UA</i> [▶ page 110] updated, section <i>Device topics</i> [▶ page 120] updated, section <i>MQTT topics</i> [▶ page 113] corrected.</p> <p><i>Diagnosis:</i> Section <i>APL LED</i> [▶ page 126] updated.</p>
4	2024-07-24	<p>Section <i>Compatibility notes</i> [▶ page 9] added. Section <i>Product software</i> [▶ page 5] updated.</p> <p>Device graphics updated: Title page, sections <i>Device overview</i> [▶ page 7] and <i>Connection example</i> [▶ page 22].</p> <p>Parameter descriptions EtherNet/IP updated, section <i>Setting parameters</i> [▶ page 28].</p> <p>Descriptions on netFIELD Wireless Web Server updated:            In sections <i>Configuration with netFIELD Wireless Web Server</i> [▶ page 33] and <i>Configuration with netFIELD Wireless Web Server</i> [▶ page 81], <i>Testing</i> [▶ page 88] and <i>Indexed Service Data Units</i> [▶ page 91].</p> <p>Safety messages updated: <i>W-Bridge Update</i> [▶ page 71] and <i>Master reset</i> [▶ page 90].</p> <p>Section <i>Wireless port status</i> [▶ page 129] updated.</p>

Table 1: List of revisions

## 1.3 Product software

All the information and software you need for your product can be downloaded free of charge at the web-link

<https://hilscher.atlassian.net/wiki/spaces/NFDIOLWM>

- Select the link for the current release for the product software.

After the download, you can start commissioning and configuring your device immediately.

- Check our website regularly for software updates for your product.

## 2 Device description

### 2.1 Functional description

The IO-Link Wireless Master **NFD-3090-EIS-IOLMW** device is intended for use within an EtherNet/IP network.

The device enables the operation of up to 16 IO-Link Devices via a wireless connection. An IO-Link Device could be an IO-Link sensor/actuator.

#### Parameterization, configuration

- The device is parameterized via EtherNet/IP. The device stores the parameters.
- Alternatively, the IO-Link Wireless Master and the wireless IO-Link ports of the device can be configured using the integrated netFIELD Wireless Web Server. The netFIELD Wireless Web Server enables you to parameterize the IO-Link Devices connected via a wireless connection to the IO-Link Wireless Master device.
- Or, you can use the IO-Link engineering tool “IO-Link E.T.” to configure the IO-Link Wireless Master and the wireless IO-Link ports of the device, as well as IO-Link Devices parameters based on IODD file.
- OPC UA Server is also integrated and offers identification, and status.
- The device provides MQTT topics for device identification, device capabilities, configuration status, address data, process data, event logs or device parameters.

For **further information** see section *Configuration tools* [▶ page 23].

## 2.2 Device overview

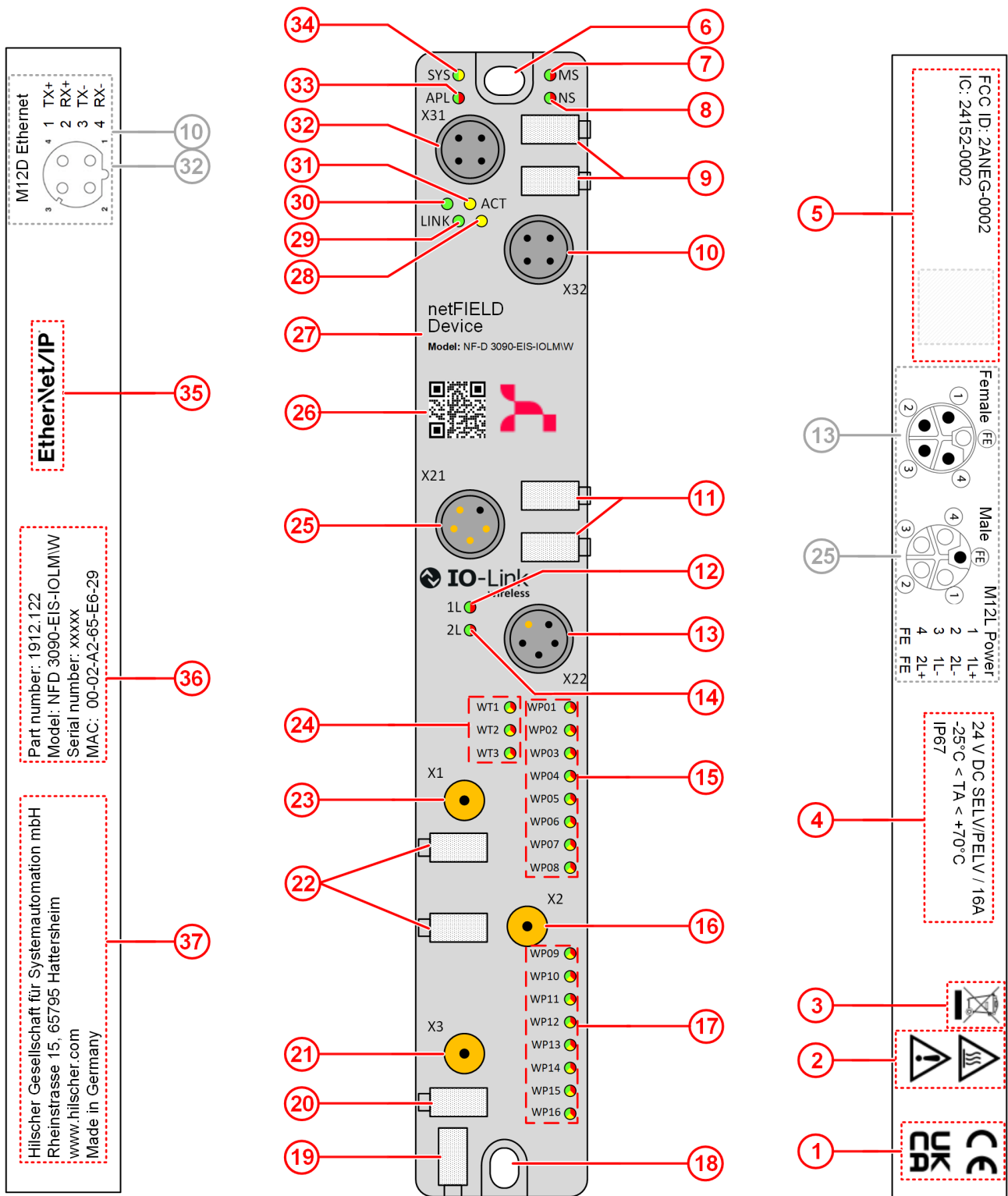

Figure 1: Device overview, NFD-3090-EIS-IOLMW

Manufacturer, product identification, and technical data can be found on the device housing as laser engravings.

Function	Pos.	Name	Description	For details, see section
Ethernet	(32)	X31	Ethernet interface, M12, D-coded, EtherNet/IP port 1 (CH0)	<i>Ethernet</i> [▶ page 11]
	(10)	X32	Ethernet interface, M12, D-coded, EtherNet/IP port 2 (CH1)	
	(30)	LINK (X31)	Link LED for connector X31	<i>EtherNet/IP Adapter status</i> [▶ page 127]
	(31)	ACT (X31)	Activity LED for connector X31	
	(28)	ACT (X32)	Activity LED for connector X32	
	(29)	LINK (X32)	Link LED for connector X32	
	(9)	-	Labeling fields Ethernet interfaces X31 and X32	-
LEDs	(34)	SYS	System status LED	<i>System LED</i> [▶ page 125]
	(33)	APL	Application status LED	<i>APL LED</i> [▶ page 126]
	(7)	MS	Module status LED	<i>EtherNet/IP Adapter status</i> [▶ page 127]
	(8)	NS	Network status LED	
Power supply	(25)	X21	Power supply input (PWR IN), M12, L-coded	<i>Power supply</i> [▶ page 11]
	(13)	X22	Power supply output (PWR OUT), M12, L-coded	
	(12)	1L (X21)	1L supply voltage status LED (DC 24 V)	<i>Supply voltage status</i> [▶ page 126]
	(14)	2L (X21)	2L supply voltage status LED (DC 24 V)	
	(11)	-	Labeling fields power supply input X21 and output X22	-
Antenna connectors and LEDs for IO-Link wireless radio module	(23)	X1	Connector for SMA antenna for IO-Link wireless connection to the IO-Link Devices 1 to 8	<i>IO-Link, SMA antenna</i> [▶ page 12]
	(16)	X2	Connector for SMA antenna for IO-Link wireless connection to the IO-Link Devices 9 to 16	
	(21)	X3	Connector for SMA antenna	
	(22), (20)	-	Labeling fields SMA antennas X1, X2, and X3	-
	(24)	WT1 ... WT3	IO-Link wireless track status LEDs	<i>Wireless track status</i> [▶ page 129]
	(15)	WP01 ... WP08	Port status LEDs for wireless IO-Link ports WP01 ... WP08	<i>Wireless port status</i> [▶ page 129]
	(17)	WP09 ... WP16	Port status LEDs for wireless IO-Link ports WP09 ... WP16	
Device identification	(26)	-	QR code	<i>Identification</i> [▶ page 10]
	(27)	-	Product group and model	
	(35)	-	Logo communication field bus	
	(36)	-	Part number, model, serial number, MAC address	
	(19)	-	Device labeling field	-
Manufacturer	(37)	-	Manufacturer address	<i>Contacts</i> [▶ page 162]
Technical data	(1), (5)	-	Space for certification signs and IDs	Technical data
	(4)	-	Power supply (SELV / PELV), fuse protection, temperature range, protection class	
Safety and disposal	(2), (3)	-	Signs on safety and environment (disposal)	<i>Mounting and demounting</i> [▶ page 17]
Mounting	(6)	-	Mounting hole and grounding	
	(18)	-	Mounting hole	

Table 2: Legend to the device overview, NFD-3090-EIS-IOLMW



## 2.3 Revisions and versions

The hardware revision listed below, as well as the software and firmware versions belong together functionally. If a hardware installation is available, for the firmware update these specifications are relevant.

Model	Description	Part number	Hardware revision
NFD-3090-EIS-IOLMW	netFIELD IO-Link Wireless Master EtherNet/IP Adapter	1912.122	4

Table 3: Hardware

Software	Version
netFIELD Wireless Web Server	1.4
IO-Link ET	1.0

Table 4: Software

Protocol	File name	Note	Version
EtherNet/IP Adapter	U197H001.nxi, U197H001.nxe, U197H001.nai	nxi for COM CPU, with nxe for extension. nai for APP CPU.	1.4

Table 5: Firmware

Description	Version
IO-Link Wireless Master stack	8.4
Radio module revision	2.0

Table 6: IO-Link Wireless Master

### 2.3.1 Compatibility notes

The (earlier) IO-Link specification V1.1 has been expanded to IO-Link specification V1.1.3.

- The IO-Link specification V1.1 has one parameter for the cycle time for input and output data,
- while the IO-Link specification V1.1.3 has two parameters: One parameter for cycle time input data and one parameter for the cycle time output data.

As a result, the following compatibility notes apply:

- The firmware version V2.2 corresponds to the IO-Link specification V1.1.
- The firmware version V1.4 corresponds to the IO-Link specification V1.1.3.

If you upgrade from V2.2 to V1.4, you must configure all parameters again.

The new specification version V1.1.3 has been applied to the firmware version V1.4.

## 2.4 Identification

On the front side of the NFD-3090-EIS-IOLM\W device housing a QR code is provided for device identification.



Figure 2: QR code (example)

The QR code includes product identification data in two lines:

1st line (with example data):

- Part number: 1912.112
- Character “R” and hardware revision number: R4
- Serial number: 020000
- MAC ID: 00-02-A2-02-20-E3

2nd line: URL link to product homepage

Example:

1912.112 R4 20000 00-02-A2-02-20-E3

<https://www.hilscher.com/netfield/netfield-device/>

To find the QR code in the device overview, see position (26) in section *Device overview* [▶ page 7].

## 2.5 Connectors and interfaces

### 2.5.1 Power supply

#### Connectors X21 and X22

The device is supplied via connector X21 (PWR IN). You can connect two supply lines to the connector:

- Supply line 1: 1L+ ( $U_{1L}$ ) and the reference potential 1L-
- Supply line 2: 2L+ ( $U_{2L}$ ) and the reference potential 2L-

Both supply lines are electrically isolated.

Each pin of connector X21 (PWR IN) is connected to the same pin of socket X22 (PWR OUT) and is used to forward the supply to the next device.

For identifying the connector X21 of the NFD-3090-EIS-IOLMW device, see position (25), and connector X22, see position (13) in section *Device overview* [▶ page 7].

Supply voltage input	Supply voltage output	Pin	Signal	Description
 <p>M12, L-coded, plug, 5-pin (4 + FE)</p>	 <p>M12, L-coded, socket, 5-pin (4 + FE)</p>	1	1L+	24 V DC supply voltage $U_{1L}$ for system and sensor/actuator
		2	2L-	Reference potential for 2L
		3	1L-	Reference potential for 1L
		4	2L+	24 V DC auxiliary/control voltage $U_{2L}$
		FE	FE	Functional earth

Table 7: Supply voltage

### 2.5.2 Ethernet

- Connector X31 for Ethernet interface port 1 (CH0)
- Connector X32 for Ethernet interface port 2 (CH1)

For identifying the connector X31 of the NFD-3090-EIS-IOLMW device, see position (32), and connector X32, see position (10) in section *Device overview* [▶ page 7].

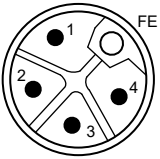
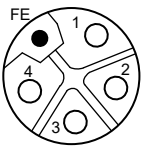
#### Connectors X31 and X32

Ethernet	Pin	Signal	Description
 <p>M12, D-coded, socket, 4-pin</p>	1	TX+	Transmit data positive
	2	RX+	Receive data positive
	3	TX-	Transmit data negative
	4	RX-	Receive data negative

Table 8: Ethernet

### 2.5.3 IO-Link, SMA antenna

With the NFD-3090-EIS-IOLMW device, two tracks with each up to 8 and together up to 16 IO-Link Devices simultaneously can be supported.

#### IO-Link Devices

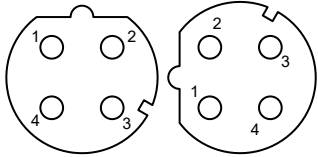
The type of data transferred (length and data type, etc.) depends on the connected IO-Link Devices.

#### SMA antenna

Antenna SMA	Type	Manufacturer
	Wifi Antenna 2.4G rubber antenna, Model: TLW2.5A-SMA-Male Bandwidth: 1000 MHz Impedance: 50 Ohms	Silram Technologies Ltd., Kfar Saba, Israel

Table 9: SMA antenna type



#### Important:

The use of an SMA antenna other than the SMA antenna supplied with the product is not permitted. This could result in losing the approval for your device.

For proper device operation, all three SMA antennas X1, X2, and X3 must be mounted.

## 2.6 Derating

Note the derating when using the netFIELD IO-Link Wireless Master device, when you connect a device to Power Out at the device and thus a larger current is passed through the device. The ambient temperature and the current have influence on the heating of the device.

The derating curve was created with the operating conditions "without air flow or with air flow 0.5 m/s" as well as "mounting on poorly heat conducting wall". The real operating conditions can lead to a better heat dissipation of the device for example by a higher air flow or a better heat dissipation to the mounting wall.

The following figure shows the maximum permissible current (I) that may flow into the device as a function of the ambient temperature (T).

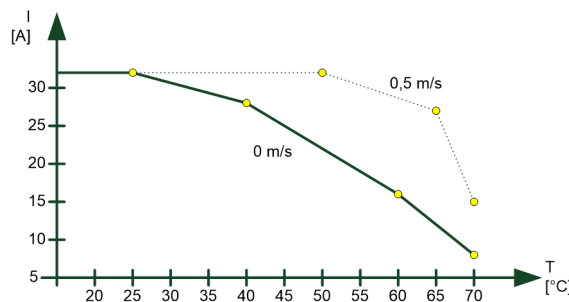

Figure 3: Derating netFIELD IO-Link Wireless Master device

## 3 Safety

### 3.1 General note

The documentation in the form of a user manual, an operating instruction manual or other manual types, as well as the accompanying texts, have been created for the use of the products by qualified personnel. When using the products, all Safety Messages, Integrated Safety Messages, Property Damage Messages and all valid legal regulations must be obeyed. Technical knowledge is presumed. The user has to assure that all legal regulations are obeyed.

### 3.2 Intended use

The device netFIELD IO-Link Wireless Master EtherNet/IP Adapter NFD-3090-EIS-IOLMW is used to receive or send process data via IO-Link:

- The IO-Link Wireless Master device receives process data from the connected IO-Link Device (sensor) and sends this data to a higher-level control system.
- The IO-Link Wireless Master device sends process data received from the higher-level control system to the connected IO-Link Device (actuator).

### 3.3 Personnel qualification

The device may only be mounted, configured, operated or demounted by qualified personnel. Job-specific technical skills for people professionally working with electricity must be present concerning the following topics:

- Safety and health at work
- Mounting and connecting of electrical equipment
- Measurement and analysis of electrical functions and systems
- Evaluation of the safety of electrical systems and equipment
- Installing and configuring IT systems

### 3.4 Power drop during write and delete accesses in the file system

The FAT file system in the netX firmware is subject to certain limitations in its operation. Write and delete accesses in the file system (firmware update, configuration download etc.) can destroy the FAT (File Allocation Table) if the accesses cannot be completed if the power drops. Without a proper FAT, a firmware may not be found and cannot be started.

- Make sure that the power supply of the device does not drop during write and delete accesses in the file system (firmware update, configuration download etc.).

### 3.5 Exceeding the maximum number of permitted write and delete accesses

This device uses a serial flash chip to store remanent data such as firmware storage, configuration storage, etc. This device allows a maximum of 100,000 write/delete accesses that are sufficient for standard operation of the device. However, writing/deleting the chip excessively (e.g. changing the configuration or changing the name of station) leads to the maximum number of permitted write/delete accesses being exceeded and to device damage. For example, if the configuration is changed once an hour, the maximum number is reached after 11.5 years. If the configuration is changed even more frequently, for example once a minute, the maximum number is reached after approx. 69 days.

Avoid exceeding the maximum permitted write/delete accesses by writing too often.

### 3.6 Information and data security

Take all usual measures for information and data security, in particular, for devices with Ethernet technology. Hilscher explicitly points out that a device with access to a public network (Internet) must be installed behind a firewall or only be accessible via a secure connection such as an encrypted VPN connection. Otherwise, the integrity of the device, its data, the application or system section is not safeguarded.

Hilscher cannot assume any warranty or liability for damage due to neglected security measures or incorrect installation.

## 4 Getting started

Below you will find an overview of the steps required for installation and commissioning of your IO-Link Wireless Master device:

Step	Description	Refer to section
Requirements and preparation	<ul style="list-style-type: none"> <li>• Prepare the device installation and commissioning according to the requirements on hardware, system, and software.</li> <li>• Prepare the required mounting tools.</li> </ul>	<i>Requirements</i> [▶ page 16] <i>Mounting</i> [▶ page 17]
Safety	<ul style="list-style-type: none"> <li>• Read the mounting instructions and the safety instructions on connecting and commissioning the device.</li> <li>• Disconnect the system to which the device will be mounted from the power supply.</li> </ul>	<i>Mounting</i> [▶ page 17]
Mounting	<ul style="list-style-type: none"> <li>• Mark the positions to fasten the device with screws and cut the M4 holes.</li> <li>• Fasten the device with the screws.</li> <li>• Ground the device.</li> <li>• Mount all three SMA antennas.</li> </ul>	<i>Mounting</i> [▶ page 17] <i>Grounding</i> [▶ page 19]
Connecting and booting	<ul style="list-style-type: none"> <li>• Connect the Ethernet M12 cable to the NFD-3090-EIS-IOLM\W device and to the PLC (EtherNet/IP Scanner).</li> <li>• Connect the +24 V DC SELV or PELV power supply to the NFD-3090-EIS-IOLM\W device.</li> <li>• Connect the +24 V DC SELV or PELV power supply to the IO-Link Device.</li> <li>• Switch on the power supply units of the device and of the IO-Link Device.</li> </ul>	<i>Connections</i> [▶ page 21]
Commissioning	<ul style="list-style-type: none"> <li>• For the first commissioning, the NFD-3090-EIS-IOLM\W device requires a DHCP server.</li> </ul> <p>In the configuration software of the EtherNet/IP Scanner:</p> <ul style="list-style-type: none"> <li>• Configure the EtherNet/IP Scanner: Import the EDS file HILSCHER-NETFIELD-WIRELESS-Vx.y.EDS,</li> <li>• Create the configuration project with EtherNet/IP Scanner and EtherNet/IP Adapter, select the connection and set the parameters.</li> </ul> <p>For the subsequent steps the following configuration tools can be used:</p> <ul style="list-style-type: none"> <li>• Configure the IO-Link Wireless Master NFD-3090-EIS-IOLM\W using the netFIELD Wireless Web Server.</li> <li>• Configure the wireless IO-Link port parameters via the configuration software of the EtherNet/IP Scanner or using the netFIELD Wireless Web Server.</li> <li>• Configure the IO-Link Device.</li> </ul>	<i>Configuration tools</i> [▶ page 23] <i>Configuring EtherNet/IP</i> [▶ page 26] <i>Commissioning</i> [▶ page 80]

Table 10: Overview for installation and commissioning

## 5 Requirements

### 5.1 Hardware and system requirements

To install your IO-Link Wireless Master you need the following hardware elements:

- Power supply: 24 V DC SELV (Safety Extra Low Voltage) or PELV (Protective Extra Low Voltage) power supply
- Power supply cable with L-coded M12 connector
- Ethernet cable with D-coded M12 connector
- EtherNet/IP Scanner (PLC)
- At least one  
IO-Link Wireless Device or  
a Wireless Bridge and a wired IO-Link Device
- 3 x SMA antenna: Use type Wifi Antenna 2.4G rubber antenna, model "TLW25A-SMA-Male" only (see section *IO-Link, SMA antenna* [▶ page 12]).

Additional components

- Ethernet network switch

For commissioning

- PC or notebook with at least one additional Ethernet port and Internet access

### 5.2 Software requirements

For commissioning and configuring your IO-Link Wireless Master, the following requirements must comply:

- Web browser if integrated netFIELD Wireless Web Server is to be used for configuration.
- DHCP server (at least required for first commissioning)

For **further information** see section *Configuration tools* [▶ page 23].



## 6 Mounting and demounting

### 6.1 Mounting

#### Required tools for mounting the device

You will need the following tools for mounting:

- Allen key for the M4 mounting screws with hexagon socket

Only additionally required for mounting without existing mounting holes:

- M4 thread tap (ready-made or set of taps)
- Drilling machine (to pre-drill the mounting holes as M4 threads for mounting the device to the system)

You will also need two M4 hexagon cylinder head screws according to DIN 912 / ISO 4762 of suitable length.

#### Before mounting the device

Always observe the following instructions:

- The device may only be mounted and commissioned by qualified electricians in accordance with EN 50110-1/-2 and IEC 60364.
- Refer to the safety instructions in the *Safety* [▶ page 13] chapter.
- Before mounting the device, check for damage, e.g. transport damage! Damaged devices must not be put into operation.

#### Mounting instructions

Observe the following points when selecting the mounting location:

- When mounting outside buildings: Mount the device in such a way that it is protected from weathering, especially from direct sunlight and the effects of UV light, salt water or salt spray, e.g. in a switch box.
- Only screw the device on flat contact surfaces to protect it from mechanical tension.
- Do not bridge any gaps with the device to protect it from any tensile forces that may occur.
- To prevent damage to the device, do not mount it in shearing areas of moving system parts. Also, lay the cables in such a way that they cannot be caught in the shear zones of moving system parts.
- Leave sufficient space for easy replacement of the device and for connecting the plug connections.
- Ensure that the requirements of the device for vibration and shock resistance are met at the mounting site.
- Mount the device so that the diagnostic LEDs of the device remain visible.

Observe the following instructions for the mounting procedure:

- Disconnect the system from the power supply before you start mounting.
- Ensure sufficient equipotential bonding in your system.
- During mounting, make sure that you do not soil the connections. Dirt will damage the contacts, resulting in reduced contact reliability.

### Notes on protection against the heat generated by the device

The device can get hot during operation! Therefore, always observe the following instructions:

- The cooling of the device must not be impaired.
- Ensure an unobstructed air supply!
- Do not install the device near strong heat sources!
- Do not mount the device on or near highly inflammable materials.

### Mounting of the device

You can attach the device directly to your system or in the control cabinet with screws. Fasten the device to a flat, solid base with two M4 screws, each of which is screwed into a mounting hole. Section *Technical data* [▶ page 138] contains the specification of the tightening torque.



#### Note:

Note that the device requires a connection to FE (functional earth) plate at the plastic housing via the screws.

---

The procedure for this is as follows:

- Hold the device in the desired position and mark the two points where the M4 threads are to be cut. Make sure that there is enough space around the device so that you can connect all cables without any problems.
- Cut an M4 thread at each of the two marked points with the M4 thread cutter, if necessary pre-drill with the drill first.
- Screw the device into the mounting holes with the Allen key using two M4 cylinder head screws of suitable length at the upper and lower ends. Observe the tightening torque.

### After mounting

Observe the notes on *Grounding* [▶ page 19].

### Mounting of the SMA antennas



#### Important:

For proper device operation, all three SMA antennas X1, X2, and X3 must be mounted.

---

## 6.1.1 Grounding

### Functional earth

The L-coded M12 connectors of the power supply of the NFD-3090-EIS-IOLM\W device have a pin FE (functional earth). You can ground the device via FE of the power supply connection or via the screws to the FE plate at the plastic housing. Grounding the device is recommended.

## 6.2 Demounting

### Required tools for demounting

For demounting, you need an Allen key to loosen the M4 hexagon socket head screws according to DIN 912 or ISO 4762.

### Before demounting

Prepare for demounting:



---

**CAUTION****Device is hot!**

During operation, high surface temperatures can occur on the housing and at the metal connections, especially at the M12 connector sleeve. If the device was in operation, let it cool down before touching it or use gloves.

- 
- Disconnect the part of the plant to which you have mounted the device from the power supply.
  - If the device is dirty, clean it first. It is particularly important to clean dirty screw connections.
  - Before demounting, loosen all screw connections at the terminals and disconnect the cables.

### Demounting

To disassemble the device, e.g. when replacing the device, proceed as follows:

- Make sure that the part of the plant on which you have mounted the device is zero-potential.
- Use the Allen key to loosen the two M4 cylinder head screws.
- Remove the device.

### After demounting

If the demounted device is defective, mark it as defective to prevent the device from being used again.

## 6.3 Disposal and recycling of waste electronic equipment

Waste electronic equipment must be disposed of properly after the end of use.



---

### Waste electronic equipment

This product must not be disposed of with household waste.

Dispose of this product in accordance with local regulations in your country.

---

When disposing of the product, observe the following:

- Observe national and local regulations for the disposal of waste electronic equipment and packaging.
- Delete personal data stored in the waste electronic device.
- Dispose of this product in an environmentally friendly manner at a local collection point for waste electronic equipment.
- Dispose of packaging in such a way that a high level of recycling is possible.

Alternatively, you can return our products to us for disposal. The prerequisite is that no additional foreign substances are contained. Before returning, please contact us via the Return Merchandise Authorization (RMA) form on [www.hilscher.com](http://www.hilscher.com).

In Europe, the directive 2012/19/EU waste electrical and electronic equipment applies. Different policies and laws may apply nationally.

## 7 Connections

### Warnings

- Adhere to the warnings hereafter before you connect the network cable and the power supply cable to the IO-Link Wireless Master NFD-3090-EIS-IOLMW device.

### WARNING!



#### Danger from electric shock, SELV or PELV power supply required

- Operate the device exclusively with 24 V DC SELV (Safety Extra Low Voltage) or PELV (Protective Extra Low Voltage) power supply. In case of ignoring this, there is a risk of electric shock.
- Always use two separate supply lines/power supplies for 1L and 2L to supply the devices. Pay attention to a central grounding (FE) if two separate power supplies are used.

USA

### WARNING



#### Danger from electric shock, SELV or PELV power supply required

- Operate the device exclusively with 24 V DC SELV (Safety Extra Low Voltage) or PELV (Protective Extra Low Voltage) power supply. In case of ignoring this, there is a risk of electric shock.
- Always use two separate supply lines/power supplies for 1L and 2L to supply the devices. Pay attention to a central grounding (FE) if two separate power supplies are used.

### NOTICE

#### Device destruction, fuse protection

The maximum supply current must not be exceeded and must be fused with an external fuse (16 A). Otherwise, the risk of device destruction cannot be excluded, damage to the printed circuit board and the connecting plug. For further details, refer to *Technical data* [▶ page 138].

#### Connection example with W-Bridge

The connection example described hereafter shows a typical installation that uses a W-Bridge to connect a wired IO-Link Device via a wireless connection to the IO-Link Wireless Master NFD-3090-EIS-IOLMW device. Section *Connection example with W-Bridge* [▶ page 22] shows a typical installation.

#### Requirements

- Use the cables described in section *Hardware and system requirements* [▶ page 16].

### IO-Link Wireless Master

- Connect the Ethernet cable to the M12 connector Ethernet **X31** of the NFD-3090-EIS-IOLMW device, see position (32) in section *Device overview* [▶ page 7] and to the PLC.
- Connect the power cable (+24 V DC SELV or PELV) to the M12 connector PWR IN **X21** of the NFD-3090-EIS-IOLMW device, see position (25) in section *Device overview* [▶ page 7].

### W-Bridge

- Connect the wired IO-Link Device with the cable to the W-Bridge.
- Connect the power cable (+24 V DC SELV or PELV) to the power connector of the W-Bridge.

## 7.1 Connection example

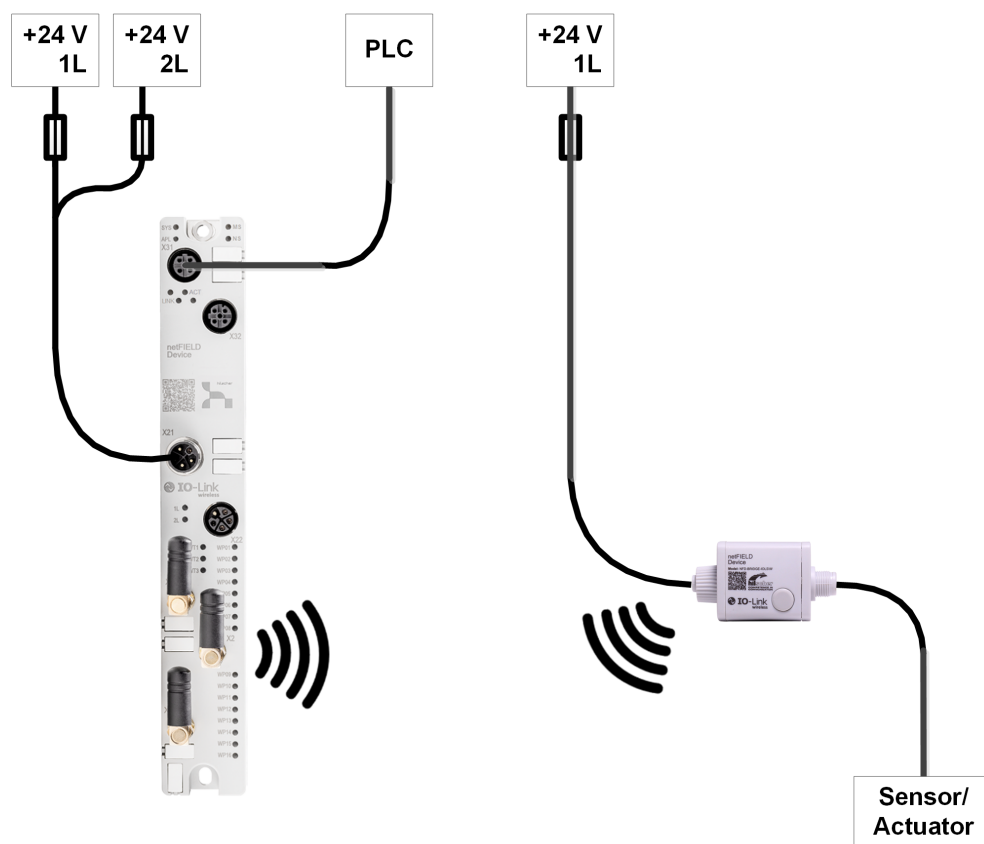

Figure 4: Connection example with W-Bridge

## 8 Configuration

### 8.1 Configuration tools

For operation, the NFD-3090-EIS-IOLM\W device requires configuration settings or parameters. The required settings or parameters can be grouped to several areas.

NFD-3090-EIS-IOLM\W device:

- EtherNet/IP connection,
- parameters for the IO-Link Wireless Master (e.g. track mode),
- parameters for the wireless port (e.g. wireless slot number).
- If the MQTT communication is used, then the MQTT Client in the NFD-3090-PNS-IOLM\W device requires MQTT parameters.

Connected IO-Link Device:

- IO-Link Device parameters.

To configure the device and to set parameters, you can use the following tools:

- **Configuration software of the EtherNet/IP Scanner:** The EtherNet/IP Scanner must be configured to exchange process data with the NFD-3090-EIS-IOLM\W device. The configuration software of the EtherNet/IP Scanner requires an EDS file to configure the device. The configuration software of the EtherNet/IP Scanner imports the EDS file, and the user can make the configuration settings and parameterizations for the device. The user loads the configuration to the EtherNet/IP Scanner. The EtherNet/IP Scanner performs the configuration and parameterization of the NFD-3090-EIS-IOLM\W device.
- **netFIELD Wireless Web Server:** A web browser can be used, to display the pages of the integrated web server. This user interface serves to set parameters during commissioning more easily. If the MQTT communication is to be used, the MQTT Client parameters are set via the netFIELD Wireless Web Server only.
- **IO-Link E.T.:** The IO-Link engineering tool serves also for device configuration, and can import IODD files of the used IO-Link Devices.

For the NFD-3090-EIS-IOLM\W device, the EDS file `HILSCHER-NETFIELD-WIRELESS-Vx.y.EDS` is available to be used in the configuration software for the EtherNet/IP Scanner for easy parameterization.

The possible tool chains for configuration are outlined below:

### Configuration software for the EtherNet/IP Scanner + netFIELD Wireless Web Server (Tool chain 1)

- Configuration software for the EtherNet/IP Scanner: Configuration of the EtherNet/IP connection. If connection 1 is used, then the EtherNet/IP Scanner sends the wireless port parameters to the device. For all other connections, the EtherNet/IP Scanner sends no wireless port parameters to the device.
- netFIELD Wireless Web Server: Settings of the IO-Link Wireless Master parameters, the wireless port parameters, and if MQTT is used, settings of the MQTT Client parameters.

**Note:**

Each time the EtherNet/IP communication starts, the EtherNet/IP Scanner transmits the configuration and parameters to the NFD-3090-EIS-IOLM\W device. If using connection 1, then the wireless port parameters, which have been set by using the netFIELD Wireless Web Server, will be overwritten. The parameters set via EtherNet/IP Scanner have priority.

---

If connection 1 is used, and you want to change parameters for the wireless ports permanently, set them with the configuration software of the EtherNet/IP Scanner.

### Configuration software for the EtherNet/IP Scanner + IO-Link E.T. (Tool chain 2)

- Configuration software for the EtherNet/IP Scanner: Configuration of the EtherNet/IP connection. If connection 1 is used, then the EtherNet/IP Scanner sends the wireless port parameters to the device. For all other connections, the EtherNet/IP Scanner sends no wireless port parameters to the device.
- IO-Link E.T.: Settings of the IO-Link Wireless Master parameters, the wireless port, and the IO-Link Device parameters based on IODD file.
- If MQTT communication is used, netFIELD Wireless Web Server: Settings of the MQTT Client parameters.

**Note:**

Each time the EtherNet/IP communication starts, the EtherNet/IP Scanner transmits the configuration and parameters to the NFD-3090-EIS-IOLM\W device. If using connection 1, then the wireless port parameters, which have been set by using the IO-Link E.T., will be overwritten. The parameters set via EtherNet/IP Scanner have priority.

---

If connection 1 is used, and you want to change parameters for the wireless ports permanently, set them with the configuration software of the EtherNet/IP Scanner.



**Overview Tool chains 1 and 2**

	EtherNet/IP connection	Parameters for the IO-Link Wireless Master	Parameters for the wireless ports	IO-Link Device parameters	MQTT Client parameters (if the MQTT communication is used)
<b>Tool chain 1</b>					
Configuration software for the EtherNet/IP Scanner	Yes	-	Connection 1: yes Connection 2-10: -	-	-
netFIELD Wireless Web Server	-	Yes	Yes If connection 1 is used, then set the wireless port parameters in the configuration software for the EtherNet/IP Scanner.	(experts)	Yes
<b>Tool chain 2</b>					
Configuration software for the EtherNet/IP Scanner	Yes	-	Connection 1: yes Connection 2-10: -	-	-
IO-Link E.T.	-	Yes	Yes If connection 1 is used, then set the wireless port parameters in the configuration software for the EtherNet/IP Scanner.	Yes IODD	-
netFIELD Wireless Web Server to configure MQTT only	-	Use IO-Link E.T. only.	Use IO-Link E.T. only.	(experts)	Yes

Table 11: Overview Tool chains 1 and 2

For more details, refer to sections *Configuration with netFIELD Wireless Web Server* [▶ page 33], and *Configuring EtherNet/IP* [▶ page 26].

## 8.2 Configuring EtherNet/IP

In order that the EtherNet/IP Scanner and the EtherNet/IP Adapter exchanges process data, the EtherNet/IP Scanner has to be configured. Therefore, you need the device description file (EDS file) of the NFD-3090-EIS-IOLMW device:

```
HILSCHER-NETFIELD-WIRELESS-Vx.y.EDS
```

Perform the following steps:

- Import the EDS file into the configuration software of the EtherNet/IP Scanner.
- Select the **netFIELD** device from the device catalog and add it to the configuration project.
- For configuration of the netFIELD device, select a connection.
- Set the parameters.

### 8.2.1 Selecting a connection

The netFIELD Device offers several types of connections:

- Exclusive owner: The Scanner can read input process data and write output process data.
- Input only: The Scanner can read input process data only.
- Listen only: The Scanner can read input process data only. This connection requires that another Scanner has established an Exclusive Owner or an Input Only connection with the netFIELD device.

The max. number of usable IO-Link Devices (for wireless connection) depends on the number of IO-Link bytes the used IO-Link Device requires to transfer. In case, one or more IO-Link Devices require to transfer 17 or more IO-Link bytes, then max. 8 IO-Link Devices can be used. In case all IO-Link Devices requires 16 IO-Link bytes or less, then up to 16 IO-Link Devices can be used.

Connection	Name	Description
Connection 1	Exclusive Owner – 8 ports x 32 bytes	Up to 8 IO-Link Devices with up to 32 IO-Link bytes and one wireless track can be used. The EtherNet/IP Scanner sends the wireless IO-Link port parameters to the netFIELD Wireless IO-Link Master device.
Connection 2	Exclusive Owner – 8 ports x 32 bytes w/o Config	Up to 8 IO-Link Devices with up to 32 IO-Link bytes and one wireless track can be used. The wireless IO-Link port parameters have to be set using the netFIELD Wireless Web Server.
Connection 3	Listen Only – 8 ports x 32 bytes	Up to 8 IO-Link Devices with up to 32 IO-Link bytes and one wireless track can be used.
Connection 4	Input Only – 8 ports x 32 bytes	Up to 8 IO-Link Devices with up to 32 IO-Link bytes and one wireless track can be used.
Connection 5	Exclusive Owner - 16 ports x 16 bytes w/o Config	Up to 16 IO-Link Devices with up to 16 IO-Link bytes and two wireless tracks can be used. The wireless IO-Link port parameters have to be set using the netFIELD Web Wireless Server.
Connection 6	Listen Only - 16 ports x 16 bytes	Up to 16 IO-Link Devices with up to 16 IO-Link bytes and two wireless tracks can be used.
Connection 7	Input Only - 16 ports x 16 bytes	Up to 16 IO-Link Devices with up to 16 IO-Link bytes and two wireless tracks can be used.
Connection 8	Exclusive Owner - 16 ports x 4 bytes w/o Config	Up to 16 IO-Link Devices with up to 4 IO-Link bytes and two wireless tracks can be used. The wireless IO-Link port parameters have to be set using the netFIELD Web Wireless Server.
Connection 9	Listen Only - 16 ports x 4 bytes	Up to 16 IO-Link Devices with up to 4 IO-Link bytes and two wireless tracks can be used.
Connection 10	Input Only - 16 ports x 4 bytes	Up to 16 IO-Link Devices with up to 4 IO-Link bytes and two wireless tracks can be used.

Table 12: Connections

## 8.2.2 Setting parameters

In the configuration software of the EtherNet/IP Scanner you can set the parameters for the device netFIELD IO-Link Wireless Master EtherNet/IP Adapter NFD-3090-EIS-IOLMW. The existing parameters contain the basic settings for the device, which you adapt for your application. Set the device and port parameters in the start-up parameters of the configuration software of the EtherNet/IP Scanner. The EtherNet/IP Scanner sends these parameters to the NFD-3090-EIS-IOLMW device when starting the communication.

If using connection 1 the following parameters have to be set.

### Parameters 10 to 89

Configure parameters 10 to 19 Port WP01,  
 Configure parameters 20 to 29 Port WP02,  
 Configure parameters 30 to 39 Port WP03,  
 Configure parameters 40 to 49 Port WP04,  
 Configure parameters 50 to 59 Port WP05  
 Configure parameters 60 to 69 Port WP06  
 Configure parameters 70 to 79 Port WP07  
 Configure parameters 80 to 89 Port WP08

No.	Parameter name	Value range	Default	Description
10, 20, ...	Port mode	0: Deactivated	0: Deactivated	The W-port is inactive. Input and output process data is 0.
		52: Cyclic, with Auto-Pairing		The W-port operates in cyclic mode with auto pairing
		53: Cyclic		The W-port operates in cyclic mode without auto pairing (requires a separate pairing step)
		54: Roaming, with Auto-Pairing		The W-port operates in roaming mode with auto pairing
		55: Roaming		The W-port operates in roaming mode without auto pairing (requires a separate pairing step)
11, 21, ...	Validation and backup	0: No Device check	0: No Device check	There is no device check for validation of Revision, Vendor and Device IDs of wireless connected IO-Link Devices (default).
		1: Type compatible device V1.0		A device check is performed for validation of wireless connected IO-Link Devices to the specified device type, without backup/restore.
		2: Type compatible device V1.1		
		3: Type compatible device V1.1, backup and restore		A device check is performed for validation or backup/restore of wireless connected IO-Link Devices to the specified device type. <i>Setting is not supported / reserved for future use.</i>
		4: Type compatible device V1.1, restore only		A device check is performed for validation or restore of the wireless connected IO-Link Devices to the specified device type, <i>Setting is not supported / reserved for future use.</i>
14, 24, ...	Vendor ID	0 ... 65535	0	See <a href="http://ioddfinder.io-link.com">ioddfinder.io-link.com</a> , or the documentation of the manufacturer of the IO-Link Device used.
15, 25, ...	Device ID	0 ... 16777215	0	Vendor ID and Device ID can be set to 0 if Validation and backup is set to "No Device check".

No.	Parameter name	Value range	Default	Description
16, 26, ...	IMA Time Base	1: 1.664 ms 2: 5 ms 3: 1 sec 4: 1 min	3: 1 sec	Used timeout base for the calculation of the I-Am-Alive time. See table <i>Calculation of I-Am-Alive time</i> [▶ page 32].
17, 27, ...	IMA Time Multiplier	1 ... 255	3	IMA timeout multiplier: Used factor for the calculation of the I-Am-Alive time. See table <i>Calculation of I-Am-Alive time</i> [▶ page 32].
18, 28, ...	W-Master cycle time output	0 ... 127	0	Cycle time of communication in operate mode The W-Master cycle time output is a W-Master parameter and sets up the actual cycle time for output data of a particular W-Port. 0 = "Free running": The Minimum W-Master cycle time output is configured, based on the PD Segmentation length, Slot Type and Max Retry configurations. See section <i>Calculation of the W-Master cycle time of the IO-Link Wireless Master</i> [▶ page 31].
19, 29, ...	W-Master cycle time input	0 ... 127	0	Cycle time of communication in operate mode The W-Master cycle time input is a W-Master parameter and sets up the actual cycle time for input data of a particular W-Port. 0 = "Free running": The Minimum W-Master cycle time input is configured, based on the PD Segmentation length, Slot Type and Max Retry configurations. See section <i>Calculation of the W-Master cycle time of the IO-Link Wireless Master</i> [▶ page 31].

Table 13: Parameters 10 to 89

**Parameters 10 to 89**

Configure parameters 410 to 426 Port WP01,  
 Configure parameters 430 to 446 Port WP02,  
 Configure parameters 450 to 466 Port WP03,  
 Configure parameters 470 to 486 Port WP04,  
 Configure parameters 490 to 506 Port WP05  
 Configure parameters 510 to 526 Port WP06  
 Configure parameters 530 to 546 Port WP07  
 Configure parameters 550 to 566 Port WP08

No.	Parameter name	Value range	Default	Description
410, 430 ...	Slot number	0 ... 7	0	Wireless slot number to be used for the port
411, ...	Track number	1 ... 3	1	Wireless track number to be used for the port
412, ...	Device TX power	1 ... 31	31	This parameter contains the transmit power level of the W-Device
413, ...	Max retry	2 ... 31	8	Maximum number of retries for a transmission in OPERATE mode
415, ...	Slot type	Single slot	Single slot	Slot type is "single slot"
		Double slot		Slot type is "double slot"
416, ...	Low power device	Not Low Power	Not Low Power	Is the connected W-Device low power or not
		Low Power		
417, ...	Max PD segment length	1 ... 32	2	This parameter contains the maximum segment length of the PDOOut data to the Message handler to distribute PDOOut data within multiple W-Cycles.
418, ...	Unique ID – Byte 0	0 ... 255	0	The Unique ID contains the Vendor ID, Device ID and serial number of the device.
419, ...	Unique ID – Byte 1	0 ... 255	0	
420, ...	Unique ID – Byte 2	0 ... 255	0	
421, ...	Unique ID – Byte 3	0 ... 255	0	
422, ...	Unique ID – Byte 4	0 ... 255	0	
423, ...	Unique ID – Byte 5	0 ... 255	0	
424, ...	Unique ID – Byte 6	0 ... 255	0	
425, ...	Unique ID – Byte 7	0 ... 255	0	
426, ...	Unique ID – Byte 8	0 ... 255	0	

Table 14: Parameters 410 to 566

### W-Master cycle time

The parameter “W-Master cycle time” is a W-Master parameter and sets up the actual cycle time of a particular W-Port. The cycle time is encoded using “Time base” (bits 6+7) and “Multiplier” (bits 0-5) values, as shown in the following table. The cycle time for the output data and input data can be set individually.

Range of values	Time base (Bits 7+6)	Multiplier (Bits 5-0)	Resulting Cycle time
0	00	0	free-running mode
1 ... 64	00	1 ... 63	Note: If the free-running mode is chosen with a time base of 0, the W-Master stack will automatically configure the Master cycle time to be the Minimum Master cycle time based on the PD Segmentation length, Slot Type, and Max Retry configurations.
65 ... 127	01: 5ms (3 W-Sub-Cycles)	1 ... 63 as multiplier	5 ms ... 315 ms (Time Base * Multiplier), (3 to 189 W-Sub-Cycles) For value 65 the resulting cycle time is 5 ms, for value 66 the resulting cycle time is 10 ms, etc. Note: For W-Devices and W-Bridges the minimum possible transmission time is 5 ms.
128 ... 255	10 ... 11: reserved	1 ... 63	reserved, do not use

Table 15: Calculation of the W-Master cycle time of the IO-Link Wireless Master

### I-Am-Alive time

The parameter “I-Am-Alive time” serves for W-Master and W-Device communication control if no other messages are transmitted. The W-Device has to send an “I-Am-Alive” messages to the W-Master before timeout, otherwise an error is reported, e.g. to start failsafe functionalities in the application.

The “I-Am-Alive time” is a 16-bit value. Bits 7–0 contain the “Time base” and bits 15–8 contain the “Multiplier”.

The “I-Am-Alive time” is calculated by multiplying the "Time base" with the "Multiplier".

The following table shows the coding of the Time base.

Value	Time base	Description
0	Reserved	reserved, do not use
1	1.664 ms	Time base is 1.664 ms
2	5 ms	Time base is 10 ms
3	1 sec	Time base is 1 sec
4	1 min	Time base is 1 min
5 ... 255	Reserved	reserved, do not use

Table 16: Time base of I-Am-Alive time

The Multiplier has the value range of 1 ... 255.

The "I-Am-Alive time" is calculated by multiplying the "Time base" with the "Multiplier", as shown in the following table:

Multiplier (Bits 15-8)	Time base (Bits 7-0)	Calculated I-Am-Alive time	Value
1	1: 1.664 ms	1.664 ms	257
	2: 5 ms	5 ms	258
	3: 1 sec	1 sec	259
	4: 1 min	1 min	260
2	1: 1.664 ms	3.328 ms	513
	2: 5 ms	10 ms	514
	3: 1 sec	2 sec	515
	4: 1 min	2 min	516
3	1: 1.664 ms	4.992 ms	769
	2: 5 ms	15 ms	770
	3: 1 sec	3 sec	771
	4: 1 min	3 min	772
4 ... 254	1 ... 4	Multiplier * Time base	Value of Multiplier * 256 + value of Time base
255	1: 1.664 ms	424.32 ms	65281
	2: 5 ms	1275 ms	65282
	3: 1 sec	255 s	65283
	4: 1 min	255 min (10 min is used)	65284

Table 17: Calculation of I-Am-Alive time

The Wireless Master verifies the calculated "I-Am-Alive time" with the following limits:

- Minimum I-Am-Alive time = W-Sub-cycle duration [ms] \* (MaxRetry + 1)  
If the calculated "I-Am-Alive time" is less than the "Minimum I-Am-Alive time", the Wireless Master uses the "Minimum I-Am-Alive time" as resulting "I-Am-Alive time".
- Maximum I-Am-Alive time = 10 minutes  
If the calculated "I-Am-Alive time" is greater than the "Maximum I-Am-Alive time", the Wireless Master uses "10 minutes" as value for "I-Am-Alive time".



## 8.3 Configuration with netFIELD Wireless Web Server

This chapter describes how you can use the integrated netFIELD Wireless Web Server to access detailed information about the current operating status of the IO-Link Wireless Master device and the connected IO-Link Devices. You also can make settings for device parameterization to influence the device behavior.

**Note:**

If there are troubles to display the content of the netFIELD Wireless Web Server pages, try to clear the internal cash of your browser (e. g. for Windows use CTRL + F5).

---

### 8.3.1 Functional overview

The following overview shows you the functions provided by the integrated netFIELD Wireless Web Server and how to access them via f the user interface.

Menu	Tab	Description	Section
Dashboard	-	Display of device-specific information	<i>Dashboard</i> [▶ page 36]
Settings	(all)	Device settings	<i>Device settings</i> [▶ page 39]
	Settings	Setting of port parameters (such as port mode, Unique ID, IMA Time, etc.)	<i>Port settings</i> [▶ page 63]
	Device configuration	Configuration for IP connection parameters	<i>IP parameters</i> [▶ page 40]
	Maintenance information	Storing maintenance information	<i>Maintenance information</i> [▶ page 41]
	Firmware update	Firmware update of the IOLWM device	<i>Firmware update</i> [▶ page 42]
	Factory reset	Device reset to factory settings	<i>Factory settings</i> [▶ page 44]
	MQTT	Client and connection configuration	<i>MQTT configuration</i> [▶ page 45]
User administration	-	Setting up and managing users	<i>Log in and user administration</i> [▶ page 37]
Sign-in, Sign-out	-	User login and logout	
IO-Link Wireless Master settings	Channel Selection	WLAN channel list	<i>Channel Selection</i> [▶ page 51]
	Configuration	Configuration of the IO-Link Wireless Master parameters	<i>Configuration</i> [▶ page 54]
	Scan	Scanning for unconnected IO-Link Devices	<i>Scan and pairing</i> [▶ page 56]
	Diagnostic	Diagnosis of wireless master and tracks temperatures	<i>Diagnostic</i> [▶ page 58]
Wireless port WP01, WP02, WP03 ...	(all)	Port-specific information and settings for the wireless IO-Link ports WP01, WP02, WP03 ...	<i>Port specific information and settings</i> [▶ page 59]
	Information	Displays device information on the connected IO-Link Device	<i>Device information</i> [▶ page 60]
	Status	Display of port status information	<i>Port status</i> [▶ page 61]
	Settings	Display (and setting) of port parameters.	<i>Port settings</i> [▶ page 63]
	Pairing	Pairing new devices (pairing by button)	<i>Pairing</i> [▶ page 69]
	W-Bridge Update	Firmware update of the W-Bridge	<i>W-Bridge Update</i> [▶ page 71]
	Device Update	Firmware update of the device	<i>Device Update</i> [▶ page 73]
	ISDU	Display of device Index Service Data Units	<i>Device ISDU</i> [▶ page 76]
Process data	Displays the process data (input/output)	<i>Port process data</i> [▶ page 79]	

Table 18: Functional overview of the netFIELD Wireless Web Server for IO-Link Devices

## 8.3.2 Open netFIELD Wireless Web Server

Prerequisite: To open the user interface of the netFIELD Wireless Web Server, the IP address of the device must be configured and known.

**Note:**

Make sure that the PC on which you want to access the website of the netFIELD Wireless Web Server and the device you want to connect to are both on the same Ethernet subnet.

---

Proceed as follows:

- Enter the following text in the address line of your web browser to address the device: `http://<Configured IP Address>` e.g.  
`http://192.168.10.179`
- ⇒ The page Dashboard of the netFIELD Wireless Web Server appears. You can now use the functions described below.

### 8.3.3 Dashboard

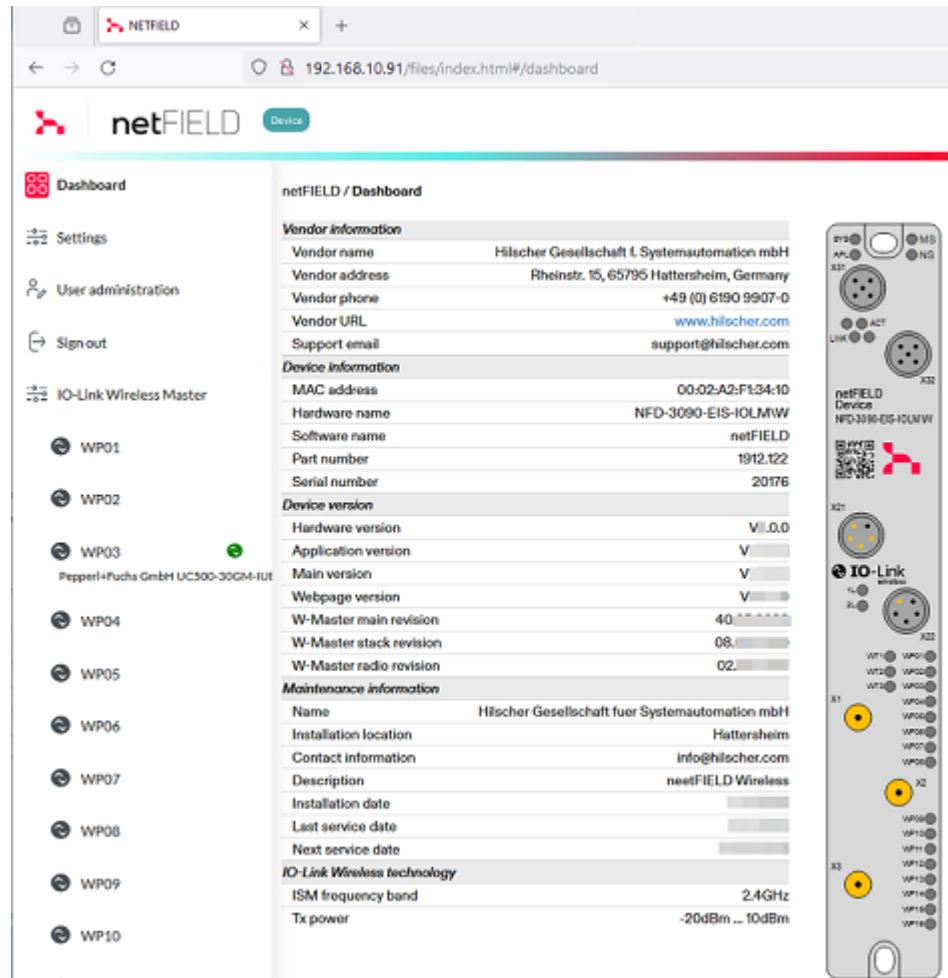

Figure 5: Dashboard page (example)

When opening the user interface, the Dashboard page appears first. On the Dashboard page, the following device-specific information is displayed:

Area	Information displayed
Left column	Navigation area; icons on errors or operating states may appear here.
Vendor information	Contact details of the device manufacturer
Device information	The name, part and version number, MAC address of the hardware
Device version	The name and version number of the device, the Master and the radio module, the web page version.
Maintenance information	Maintenance information in text form
IO-Link Wireless technology	Specification of the radio connection

Table 19: Data on "Dashboard" page

#### Maintenance information

Maintenance information includes textual information that the user can specify, such as device name, installation location and date, contact information, description, date of last and next service of the device. These texts can be edited using the **Maintenance information** tab of the **Settings** menu (see section *Maintenance information* [▶ page 41]).

## 8.3.4 Log in and user administration

### Log in user

**Note:**

A log in is only possible when device connection state is “connected” (top left corner of the netFIELD Wireless Web Server).

To log in as a user

- Select **Sign in** in the left column of the netFIELD Wireless Web Server.
- The input mask for user name and password appears:

The image shows a login form with two input fields. The first field is labeled 'Username' and the second is labeled 'Password'. Below the fields is a red button with the text 'Sign in' in white.

Figure 6: Menu item SignIn - Input mask for user name and password

- Enter your user name and password correctly in the corresponding input fields of the screen mask.
- Click **Sign in**.
- If you have entered a known user name correctly, you now can work with the netFIELD Wireless Web Server with the defined rights of this user. The user role (*Operator, Maintenance, Admin*) used for sign in is displayed in the upper left corner. The previous menu entry **Sign in** changes and is now called **Sign out**.

### Logging off users

To log off a user:

- Click on the **Sign out** menu item in the main menu of the netFIELD Wireless Web Server (left side).
- From now on, you can no longer work with the netFIELD Wireless Web Server with the previous rights. The user role *guest* appears in the upper left corner. The previous menu entry **Sign out** changes and is now called **Sign in** again.

### Guest user access

By default, the netFIELD Wireless Web Server knows a user *guest* without password, which has been set up to realize a first-time or guest access.

### First-time login as administrator

In the delivery state or after resetting to the factory settings, the netFIELD Wireless Web Server can be accessed via the user name “root” and the password “password”. This combination also has administrator rights.



**Important:**

Change the administrator password immediately after commissioning. The factory default setting is generally known and does not provide sufficient protection.

### User Administration

- Select **User administration** in the left column of the netFIELD Wireless Web Server.

The Administration pane provides a role-based user administration. You can use it to create and delete users and assign roles to them on which their rights depend. Users can be divided into three roles:

- Maintenance
- Operator
- Administrator

### Creating a new user

When opening the user administration the following picture appears:

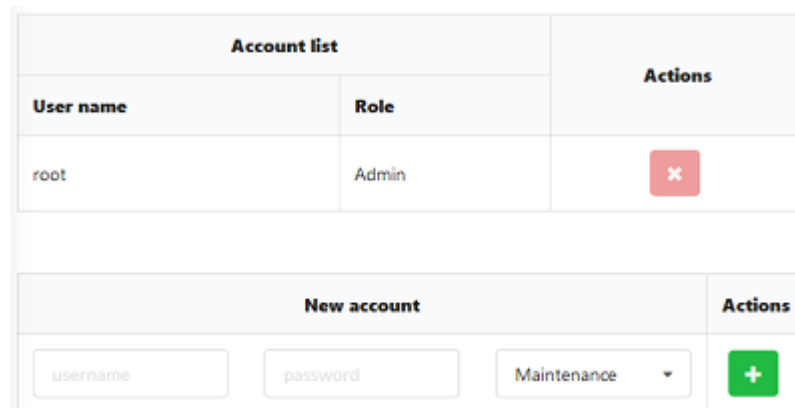





Figure 7: User Administration screen mask (initial state)

Another user can be defined in the second line. Proceed as follows:

- In the Username input field (left side), enter the user name that is to be used for the user. User names that have already been used are not permitted here.
- In the Password input field (middle), enter the password for this user name.
- Use the combo box on the right to select the role for the new user to be created (the roles Maintenance, Operator or Administrator are available).
- Finally, click on the green field.
- The new user is created and assigned to the selected role.

Account list		Actions
User name	Role	
root	Admin	
user1	Maintenance	
operator1	Operator	

New account			Actions
<input type="text" value="username"/>	<input type="text"/>	Operator ▾	

Figure 8: User Administration screen mask

### Remove user

To remove an existing user from the device user management, proceed as follows:

- Click the red square with a white cross to the right of the user to be removed.
- ⇒ The user will be deleted.

The “root” user cannot be deleted, so the red delete button is grayed out.

## 8.3.5 Device settings

Using the netFIELD Wireless Web Server, you can make several settings on the device. Open the panes via the left column of the netFIELD Wireless Web Server.

- Select the wireless IO-Link port (**WP01**, **WP02**, **WP03** ...) and open the subtab **Settings**, to make the port settings (see section *Port settings* [▶ page 63]).
- Select **Settings** in the left column and open the corresponding tab:
  - Device information (with menu on the *IP parameters* [▶ page 40]),
  - *Maintenance information* [▶ page 41],
  - *Firmware update* [▶ page 42],
  - *Factory settings* [▶ page 44],
  - *MQTT configuration* [▶ page 45].

### 8.3.5.1 IP parameters

- Select **Settings** in the left column of the netFIELD Wireless Web Server.
- The Device configuration tab is displayed.

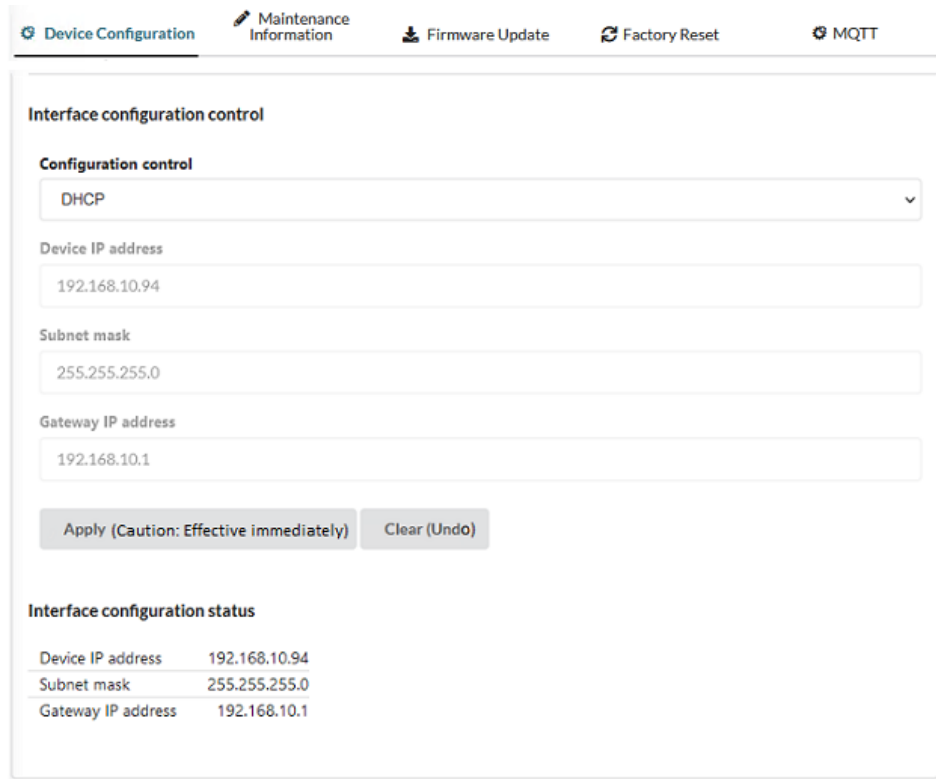

Figure 9: Device configuration tab (example)

The **Device configuration** tab allows you

- to define how the module obtains its IP address (via the **Configuration control** selection list, STATIC, BOOTP and DHCP options).

#	Option	Description
0	STATIC	The IP address of the module is configured statically. This is done using the device IP address, subnet mask, and gateway IP address entered in the <b>Device configuration</b> tab.
1	BOOTP	The device obtains its IP address via the BOOTP protocol.
2	DHCP	The device obtains its IP address via the DHCP protocol. This is the default setting.

Table 20: Selection list „Configuration control“

- If static configuration is used, set the IP address and subnet mask manually (the gateway IP address is optional).

Parameter	Settings or Action
Device IP address	IP address for ETHERNET communication if static configuration of IP address is used
Subnet mask	Subnet mask for ETHERNET communication with static configuration of the IP address
Gateway IP address	Gateway IP address for ETHERNET communication with static configuration of the IP address

Table 21: Device configuration tab- Parameter



### 8.3.5.2 Maintenance information

The Maintenance information tab is used to store maintenance information such as device name, installation location and date, contact information, a description text, or the date of the last and next service on the device.

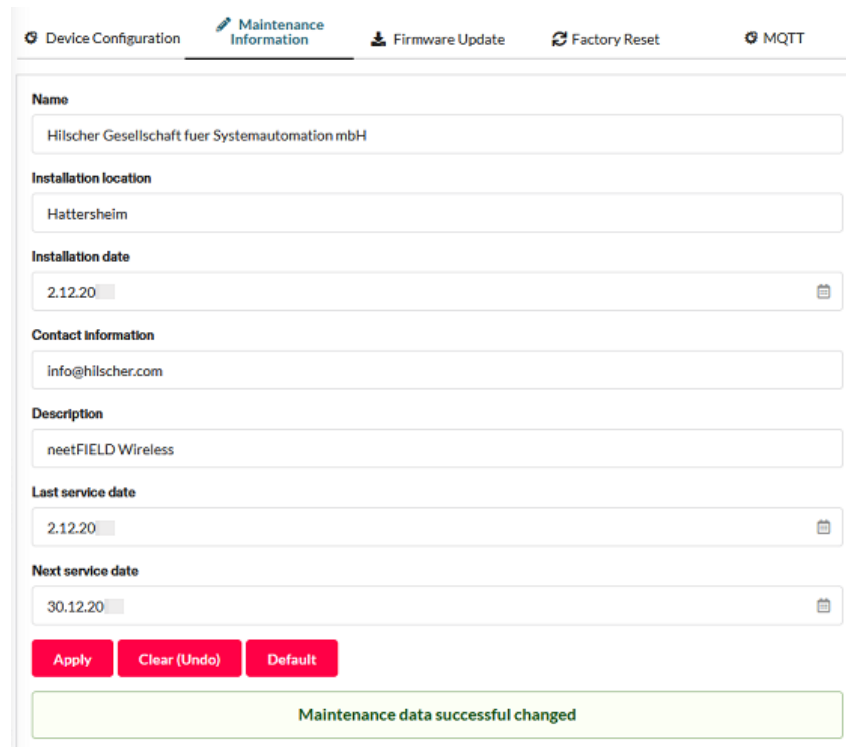

Figure 10: Maintenance information tab

Name	Description	Value / Value range
Name	Uniform label for the function of this device	Character string, max. 64 char.*
Installation location	Uniform label for the location where the device is mounted	Character string, max. 32 char.*
Installation date	Date of installation or commissioning of this device	Valid installation date
Contact information	Textual identification of a contact person for this managed node of the installation, together with information on how to contact this person.	Character string, max. 32 char.*
Description	Individual status information and remarks	Character string, max. 64 char.*
Last service date	Date/time of the last service, e.g. firmware update	Valid last service date
Next service date	Date/time of the next service, e.g. firmware update	Valid next service date
-	-	(*no mutated vowels)

Table 22: Maintenance information details

Changes to settings require operator or admin rights. If they are not available, the tab is grayed out and cannot be edited.

To make changes to the maintenance information:

- Click **Settings** in the left column of the netFIELD Wireless Web Server.
- The Device configuration tab appears.
- Select the **Maintenance information** tab.
- Change the relevant fields there. Do not use mutated vowels in character strings.
- Click **Apply**.
- Your changes take effect.

### 8.3.5.3 Firmware update

The netFIELD Wireless Web Server provides a way to update all firmware required for the IO-Link Wireless Master NFD-3090-EIS-IOLM\W device via the Firmware update tab.

- Select **Settings** in the left column of the netFIELD Wireless Web Server.
- Open the **Firmware update** tab.

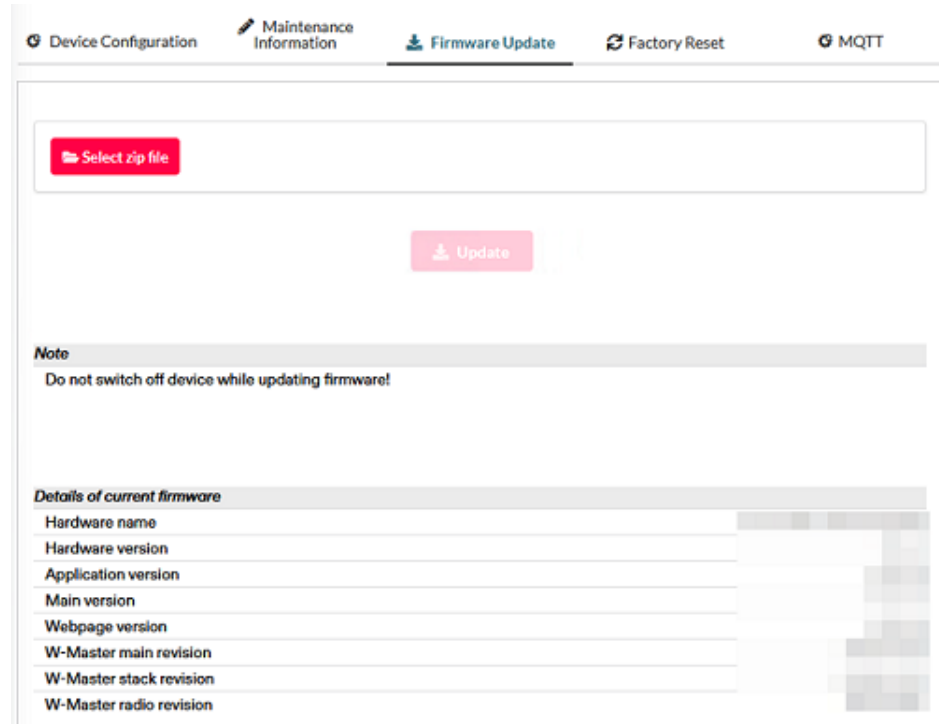

Figure 11: Firmware update tab (example)

#### NOTICE

##### Bring the system in a fail-safe state before downloading a firmware

Do not start a firmware download while the system with the NFD-3090-EIS-IOLM\W is in data exchange process. A firmware download will stop the process data communication. A subsequent system stop may cause unpredictable behavior of machines and system components.

- Make sure that the device and all connected devices are in a fail-safe condition before you start a firmware download.

#### NOTICE

##### Keep device powered during the firmware download

If the power supply to the computer or device is interrupted while the firmware is being downloaded, the download will be aborted, the firmware may be corrupted, the device parameters may be lost, and the device may be damaged.

- During the firmware download process: Do not interrupt the power supply to the computer or to the device, and do not perform a reset to the device!

**Important:**

Backup your firmware and configuration data before you update the firmware of your device! Otherwise, you cannot restore the state of your device prior to the update, including the previously used firmware.

Changes to settings require operator or admin rights. If these are not available, the Firmware update tab is grayed out and cannot be edited.

To update the firmware, you need the file `NFD_[protocol name]_Wireless_V[version].zip` containing all firmware required for the NFD-3090-EIS-IOLMW device. You can download this from the website of the device manufacturer or provider.

**Note:**

Do not change the name of the `NFD_[protocol name]_Wireless_V[version].zip` file.

- In the **Firmware Update** tab, click on **Select zip file**.
- A file selection dialog appears.
- Select the file `NFD_[protocol name]_Wireless_V[version].zip` in this dialog.
- Click **Update**.
- The firmware update is performed. This takes a short while.

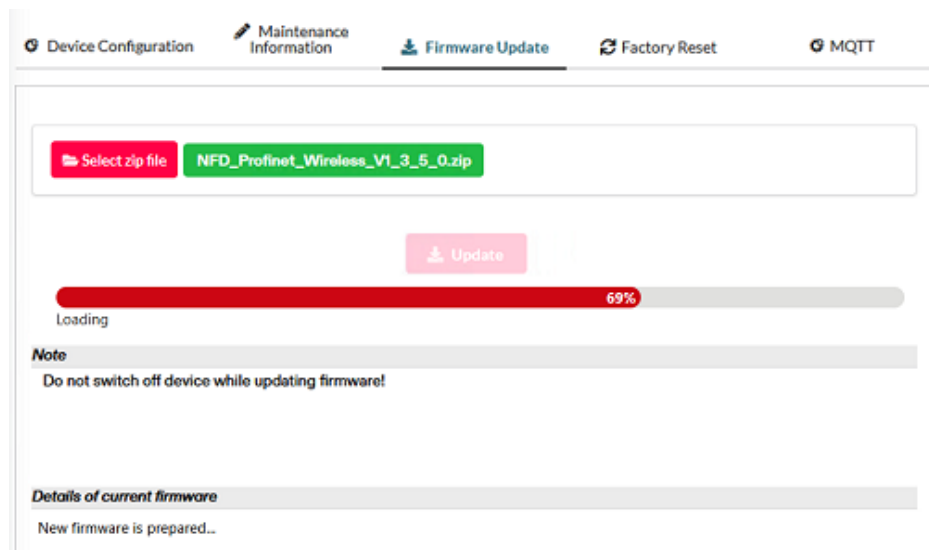

Figure 12: Firmware update is performed (example)

- ⇒ A message appears indicating that the firmware update was finished, and the device will be restarted after pressing OK and has a new (possibly different) IP address.
- Click **OK**.
- Then you must perform the port configuration once again.

### 8.3.5.4 Factory settings

In some cases, it is helpful to reset the device to the factory settings. This is possible for various selectable classes of settings via the Factory reset tab in the Settings menu.

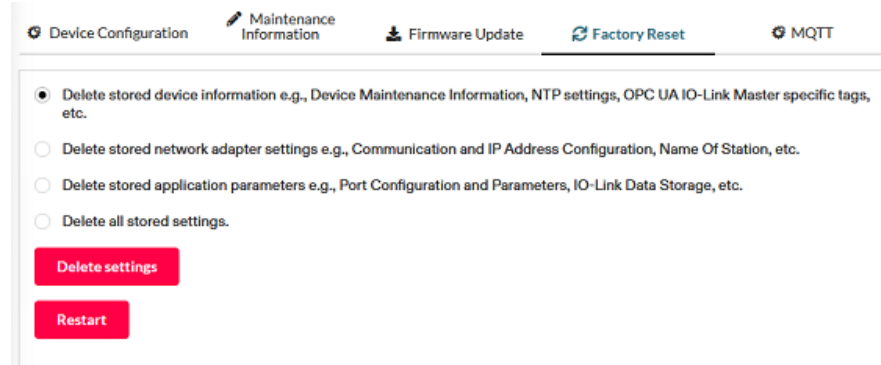

Figure 13: Factory reset tab

Option	Delete stored configuration
Delete stored device information	Device information (e. g. maintenance information, system time settings, and IO-Link master settings within OPC UA)
Delete stored network adapter settings	Network adapter settings (communication settings, IP address configuration, Name of Station)
Delete stored application parameters	Application-specific data (port configuration and parameters, remanent parameters)
Delete all stored settings	All settings

Table 23: Options to delete settings



**Important:**

**Bring the system in a fail-safe state before factory reset**

Do not start a factory reset while the system with the device is in data exchange process. While PLC communication is active, factory reset is inhibited!

- Make sure that the device and all connected devices are in a fail-safe condition before you start a factory reset.
- Then, you stop PLC communication and perform the factory reset.

If you try to perform a reset to factory state while PLC communication is active, the message appears that factory reset is not allowed !

Changes to settings require operator or admin rights. If these are not available, the tab is grayed out and cannot be edited.

To reset the device to the factory settings:

- Click **Settings** in the left column of the netFIELD Wireless Web Server.
- The Device configuration tab appears.
- Select the **Factory reset** tab.
- Select which settings should be reset to the factory defaults.
- Click on **Delete settings**.
- ⇒ The selected settings are deleted.
- Click on **Restart**.
- ⇒ The device is restarted with the factory settings.

### 8.3.5.5 MQTT configuration

Use the MQTT tab to view and change the MQTT client and connection configuration.

- Select **Settings** in the left column of the netFIELD Wireless Web Server.
- Open the **MQTT** tab with its sub tabs.
- The Client Status appears, and by default the Client Configuration sub tab.

#### MQTT > Client Status, and Client Configuration

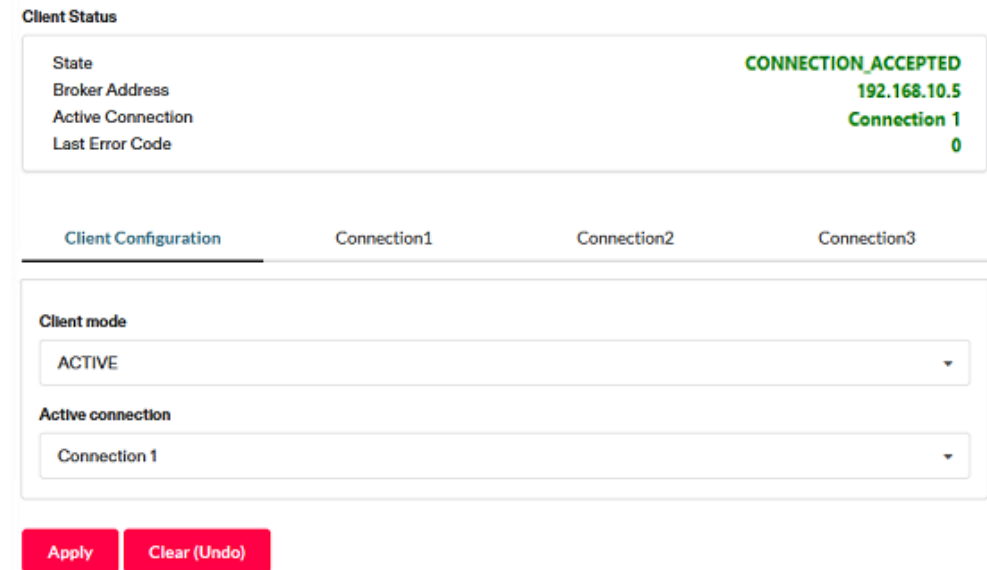

Figure 14: MQTT tab, Client Status, Client Configuration sub tab (example)

Parameter	Description	Value / Value range
State	States 1, 2: "CONNECTING" State 3: "CONNECTION_ACCEPTED" States 0,4,5,6: "CLIENT_INACTIV" Connection state code 0: Ready: initialization value, connection not established. 1: Connecting: TCP connection establishment in progress. 2: TCP Connected: TCP connection established. MQTT connection in progress. 3: MQTT Connected: MQTT connection established. 4: Disconnecting: MQTT connection shutdown in progress. 5: Disconnected: TCP connection terminated. 6: Wait Reconnect: Waiting for reconnection to be allowed again. See "Connect Timeout" parameter.	CONNECTING (red), CONNECION_ACCEPTED (green), CLIENT_INACTIVE (red)
Broker Address	Current value for "Broker Address"	Example: 192.168.10.5
Active connection	Current value for "Active connection", respectively active connection configured.	Example: Connection 1
Last Error Code	Last error code, related to this connection.	Example: 0

Table 24: MQTT in port configuration for IO-Link Device, Client Status

Parameter	Description	Value / Value range
Client mode	"ACTIVE" means MQTT client application is enabled and "INACTIVE" means disabled.	INACTIVE (default), ACTIVE
Active connection	Active connection configured.	Connection 1 (default), Connection 2, Connection 3

Table 25: MQTT in port configuration for IO-Link Device, Client Configuration

- For MQTT Client Configuration make the following settings and configuration steps:
  - Client mode
  - Active connection

**MQTT > Connection1 > IP settings**

- Open the **Connection1** sub tab.
- The IP settings sub sub tab appears by default.

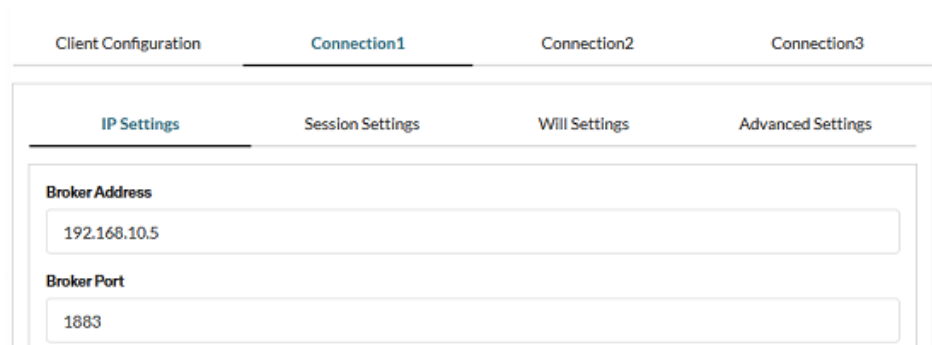

Figure 15: MQTT tab, Connection1 > IP settings sub sub tab (example)

Parameter	Description	Value / Value range
Broker Address	IP address of the broker.	Valid IP address, Default: [BrokerAddress],
Broker Port	MQTT broker port number.	Typically: 1883

Table 26: MQTT in port configuration for IO-Link Device, Connection1 > IP settings

- For MQTT Connection Configuration make the following settings and configuration steps:
  - Broker Address
  - Broker Port

**MQTT > Connection1 > Session settings**

➤ Open the **Session settings** sub sub tab.

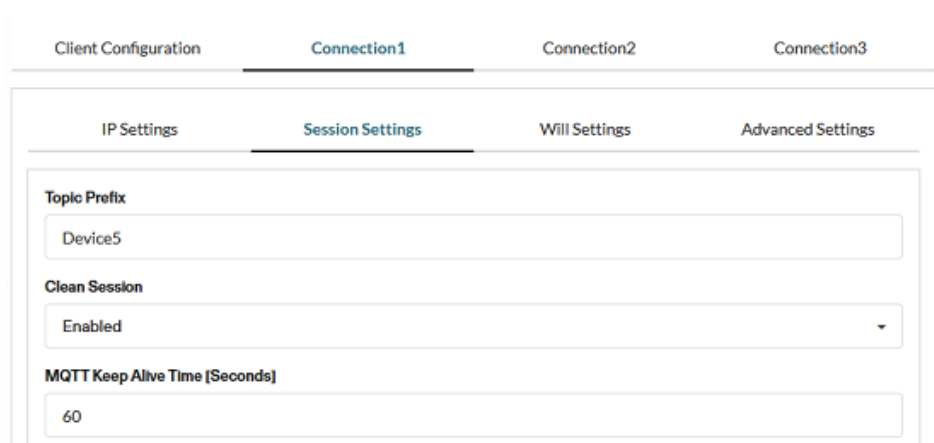

Figure 16: MQTT tab, Connection1 > Session settings sub sub tab (example)

Parameter	Description	Value / Value range
Topic Prefix	Text that is prefixed to each topic, e. g. 'StationA'. For each single topic can be configured if this prefix is to be preceded or not. If left empty the firmware will try to use the MAC address.	Text of uppercase and lowercase letters and underscore, Default: [not specified]
Clean Session	Setting whether all topics are to be transferred to the broker after establishing a connection or not. Enabled (default): After a connection to the broker has been established, all topics of the type 'publish' are transmitted from the MQTT client to the broker . Disabled: Only those topic are transmitted to the broker, which have changed since the last connection. Note that if you use this setting, the broker must support the 'preserve context' function.	Enabled (default), Disabled
MQTT Keep Alive Time [Seconds]	Interval in which the MQTT client sends a sign of life to the broker. The set value for the MQTT client must be less than the monitoring time set in the broker. Enabling this timeout is suitable if the connection is used for at least one subscription so a permanent connection to the broker is required. Not allowed to be enabled together with the Connection Idle Timeout.	Specified in s. 0 = send no sign of life to the broker. Default: 0

Table 27: MQTT in port configuration for IO-Link Device, Connection1 > Session settings

- For MQTT Connection Configuration make the following settings and configuration steps:
  - Topic Prefix
  - Clean Session
  - MQTT Keep Alive Time

### MQTT > Connection1 > Will settings

- Open the **Will settings** sub sub tab.

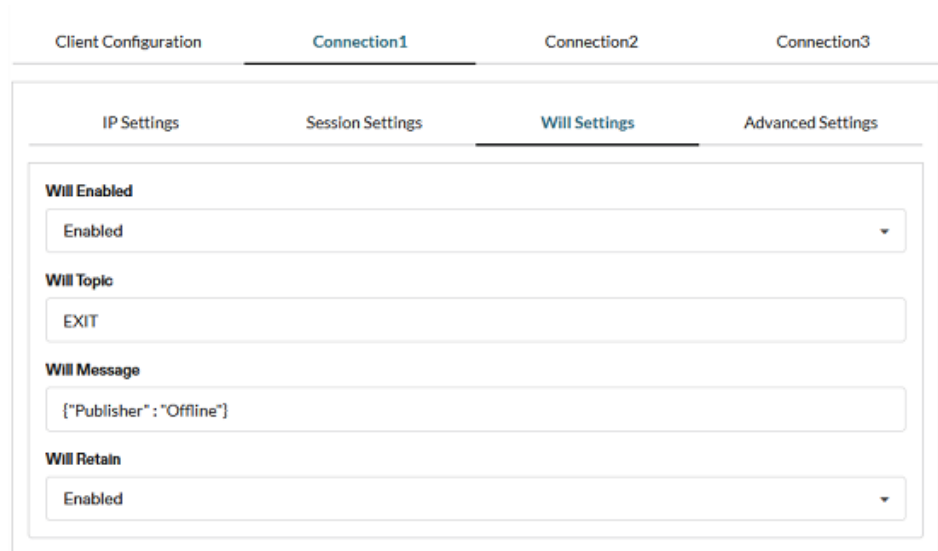

Figure 17: MQTT tab, Connection1 > Will settings sub sub tab (example)

Parameter	Description	Value / Value range
Will Enabled	Enable this option if you want to use the “will” feature of MQTT.	Enabled (default), Disabled
Will topic	Unique name for the topic, editable. If left empty the firmware will use the string constant "will" prefixed by the Prefix Will if enabled.	Max. 128 characters of text from uppercase and lowercase letters and underscore; Default: [not specified]
Will Message	Payload forwarded by the broker to other clients subscribed to the will topic in case of abnormal disconnection (when an MQTT Disconnect packet was not sent to the broker). If left empty, the string "Disconnected" is sent.	Text of uppercase and lowercase letters and underscore; Default: [not specified]
Will Retain	Setting whether the broker shall store the history of a data value or not.	Enabled (default), Disabled

Table 28: MQTT in port configuration for IO-Link Device, Connection1 > Will settings

- For MQTT Connection Configuration make the following settings and configuration steps:
  - Will Enabled
  - Will Topic
  - Will Message
  - Will Retain



### MQTT > Connection1 > Advanced settings

➤ Open the **Advanced settings** sub sub tab.

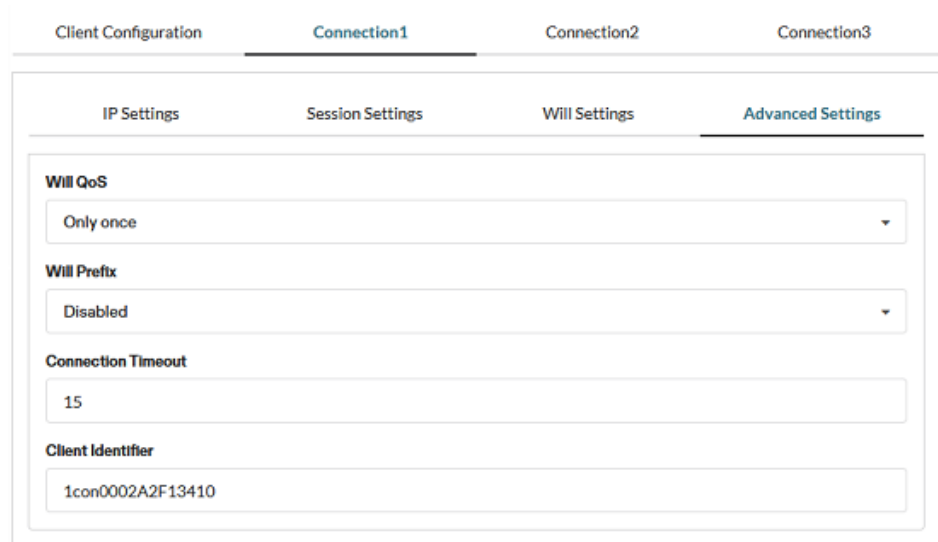

Figure 18: MQTT tab, Connection1 > Advanced settings sub sub tab (example)

Parameter	Description	Value / Value range
Will QoS	Quality of Service Level for the Will Message. 0: "Only once": fire and forget 1: "At least once": acknowledged delivery 2: "Exactly once": assured delivery	Only once (default), At least once, Exactly once
Will Prefix	Text that is prefixed to each Will topic. For each single topic can be configured if this prefix is to be preceded or not.	Text of uppercase and lowercase letters and underscore, Default: [not specified]
Connection Timeout	Time for trying to establish a connection (MQTT Connect) to the broker. If the connection could not be established, then the MQTT client waits for the duration of 'Connection Timeout' until a new connection is established to the broker.	Specified in s. = 0 MQTT client constantly tries to establish a connection to the broker. Default: 0
Client identifier	Unique name of the MQTT client in UTF-8 format used at connection establishment time. All devices that are connected to a broker, must have a unique name. The name may only consist of lowercase letters, uppercase letters and numbers. If the field is empty, then the broker assigns a name.	max. 23 Bytes for max. 23 characters, Default: [Client ID] Example: "ClientId1"

Table 29: MQTT in port configuration for IO-Link Device, Connection1 > Advanced settings

- For MQTT Connection Configuration make the following settings and configuration steps:
  - Will QoS
  - Will Prefix
  - Connection Timeout
  - Client Identifier

### 8.3.6 IO-Link Wireless Master settings

The netFIELD Wireless Web Server provides the IO-Link Wireless Master settings with the tabs Channel Selection, Configuration and Scan.

- Select **IO-Link Wireless Master**, to display the tabs.
- The **Channel Selection** tab allows you to select the WLAN channels required for device operation.
- On the **Configuration** tab, you can make the IO-Link Wireless Master configuration settings. This includes the specific master settings parameters, the activating or deactivating of wireless tracks WT1 ... WT3, as well as specification of the track transmission power.
- On the **Scan** tab, you can scan for unconnected IO-Link Devices. A scan result then shows the found devices. Each of them must be paired to one of the 16 wireless IO-Link ports (WP01, WP02, WP03, ...).
- On the **Diagnostics** tab, the current, minimum, and maximum temperature values of the wireless master core as well as of the wireless tracks 1, 2 and 3 are displayed.

### 8.3.6.1 Channel Selection

- Select **IO-Link Wireless Master** in the left column of the netFIELD Wireless Web Server.
- The **Channel Selection** tab appears.

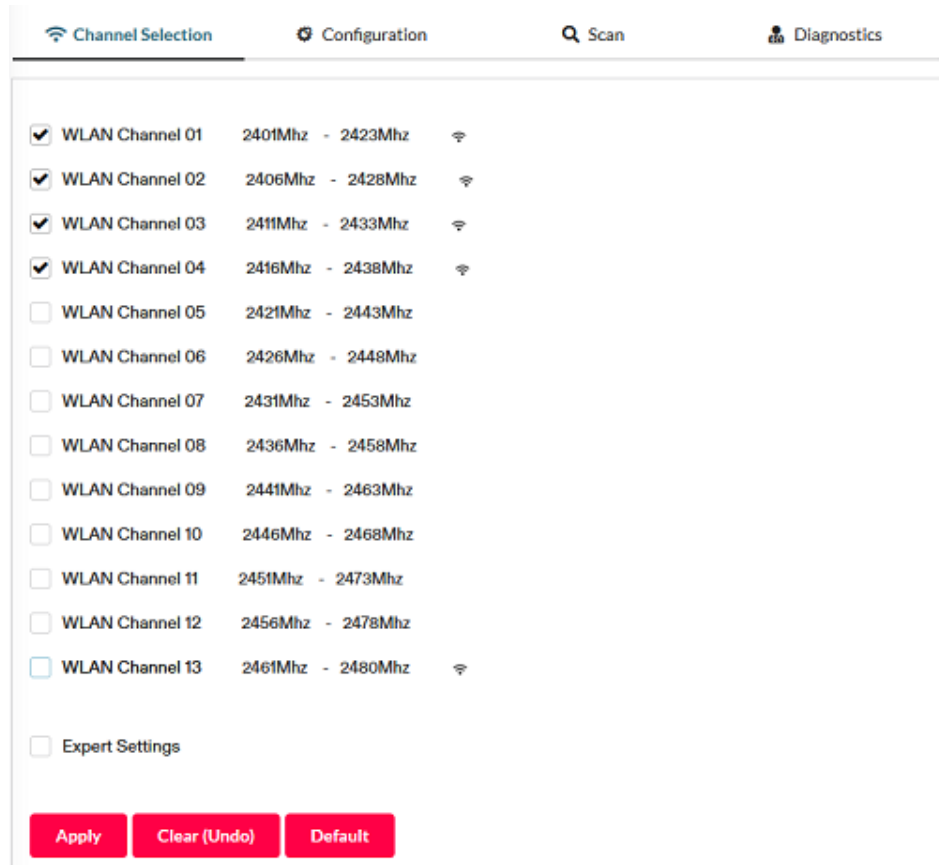

Figure 19: Channel selection tab

Use the Channel Selection tab to select the WLAN channels required for operation.



Parameter	Description	Value, Value range
WLAN Channel 01 ... WLAN Channel 13	<p>List of WLAN channels 01 to 13 on the 2.4 GHz frequency band.</p> <p>The radio symbols indicate whether a channel is activated and if fully or partly.</p> <p>Use mouse over to indicate the help text.</p> <p></p> <p></p>	"checked", "unchecked" (default)

Table 30: IO-Link Wireless Master settings - Channel selection

- Select the operating channels required for device operation.
- Click **Apply**.
- The selected WLAN channels are configured.

## Expert settings

The expert mode allows a refinement of the transmission frequencies to be used. Here, each individual operating channel can be activated or deactivated. Since the list of operating channels is based on the WLAN channels, there are overlaps. When activating/deactivating the operating channels, these overlaps are automatically taken into consideration.

The complete range of wireless operating channels comprises 80 bitwise coded 1 MHz frequency channels.

- The wireless channels 1 (2401 MHz), 2 (2402 MHz), 79 (2479 MHz) and 80 (2480 MHz) are used for network configurations and cannot be configured.
- The wireless channels 3-78 (2403 ... 2478 MHz) can be configured to be used or not for IO-Link wireless communication within a Wireless Master. Frequency Hopping is used for transmission on different frequency channels on the 2.4 GHz Band frequency.



### Note:

The ranges of wireless operating channels assigned to each of the WLAN channels 01 to 13 overlap each other. In consequence, if a 1 MHz frequency channel option is configured for one WLAN channel, this will have effect on the corresponding 1 MHz frequency channel that is also assigned to a WLAN channel in the neighborhood.

---



### Important:

The use of this mode is for experts only!

---

- Check **Expert settings**.
- ↻ The following view appears with configuration options of each single MHz frequency.

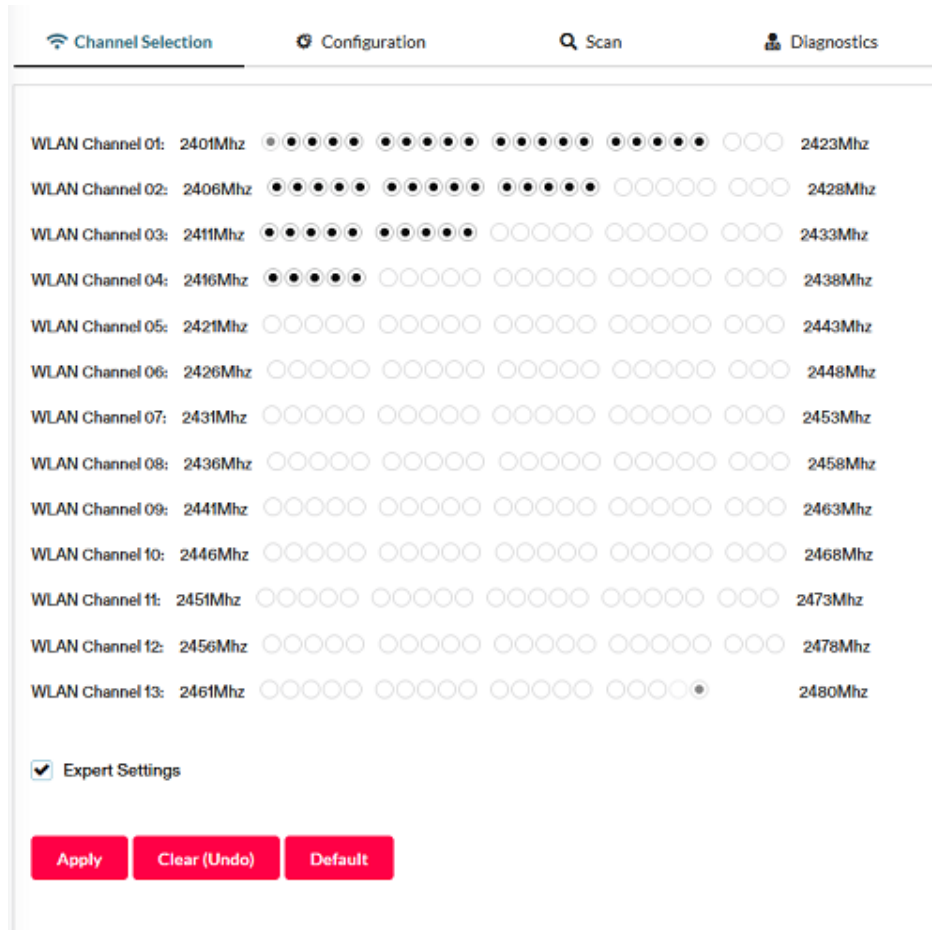

Figure 20: Channel selection tab, Expert settings (example)

### 8.3.6.2 Configuration

- Select **IO-Link Wireless Master** in the left column of the netFIELD Wireless Web Server.
- Then select the **Configuration** tab.

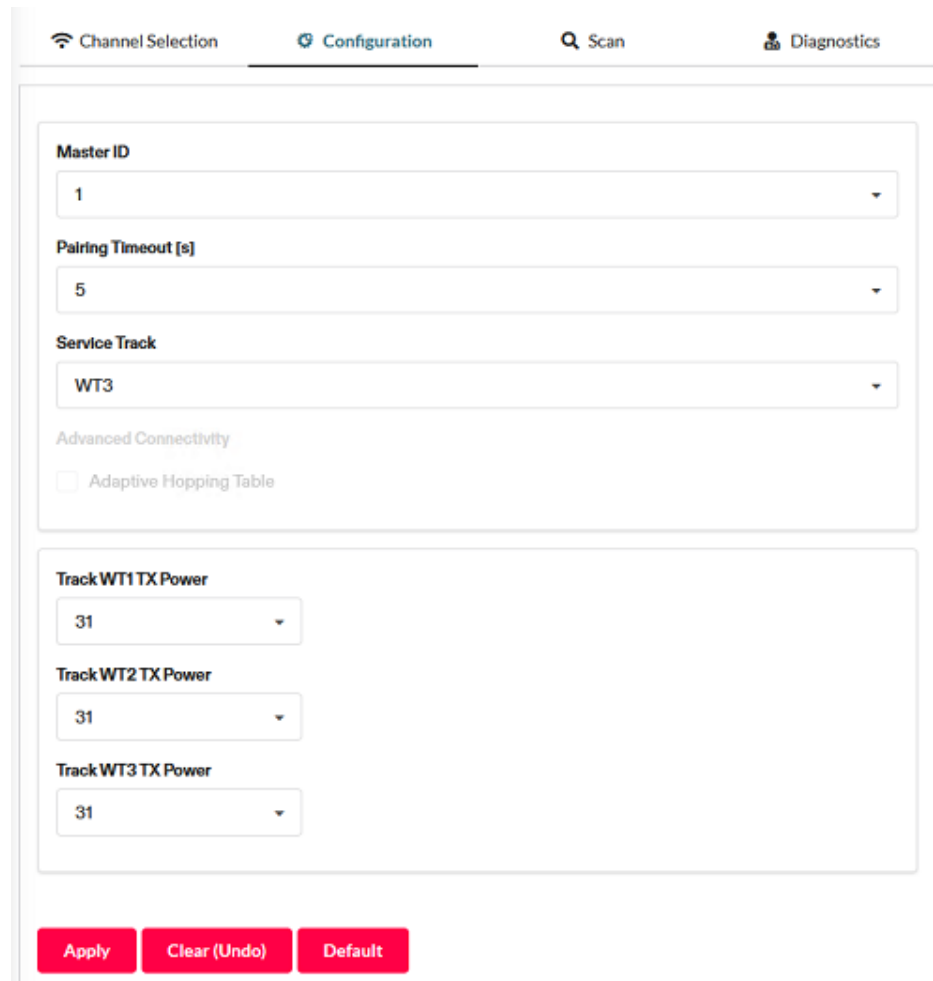

Figure 21: IO-Link Wireless Master > Configuration tab

Use the IO-Link Wireless Master > Configuration tab to view or adapt the IO-Link Wireless Master settings:

Parameter	Description	Value, Value range
Master ID	Master identifier according to IOLW specification	1 ... 29, 0: when not yet configured
Pairing Timeout	Timeout for pairing in seconds.	5 ... 60, 0: when not yet configured
Service Track	Selection of wireless track for configuration. This is the W-Track number used for service requests (Scan/Pairing/ Roaming).	WT1 (default), WT2, WT3
Advanced Connectivity (intended for future use)	Wireless functionalities Adaptive Hopping Table: Option on enhancement to Frequency Division Multiple Access (FDMA) technology.	-
Track WT1 TXPower, Track WT2 TXPower, Track WT3 TXPower	Transmission power of the WTrack1, WTrack2, or WTrack3 The maximum allowable value for the TX Power parameter is selected by the IO-Link Wireless Master.	1 ... 31, Default: 31

Table 31: IO-Link Wireless Master settings - Configuration

- Make settings for the parameters “Master ID”, “Pairing Timeout”, and “Track WT1 TXPower ... Track WT3 TXPower”.
- Click **Apply**.
- The request appears Applying configuration will restart the device. Are you sure?
- Click **Yes**.
- Wait until reset operation is finished and result is shown:
- The message Master configured successfully appears.

#### “Master configuration failed” error handling

When the IO-Link Wireless Master went to an error status, a red triangle icon  appears for Master in the left column of the netFIELD Wireless Web Server and the message Master configuration failed. For trouble shooting:

- Delete the Master configuration.
- Perform a device reset.

For further information, refer to *Configuring the IO-Link Wireless Master* [▶ page 82].

### 8.3.6.3 Scan and pairing

- Select **IO-Link Wireless Master** in the left column of the netFIELD Wireless Web Server.
- Open the **Scan** tab.

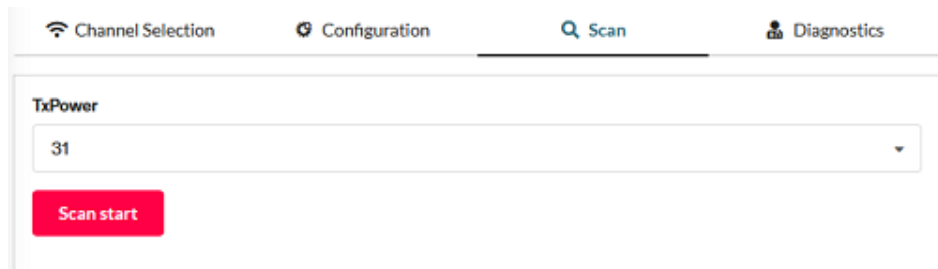

Figure 22: Scan tab

Use the Scan tab, to scan for unconnected devices.

- Select **TxPower**.

The value range of “TxPower” (Transmission power) is “1 ... 31” and the default value “31”.

- Click **Scan start**.

- The system searches for unconnected devices. The scan result is being displayed after a while.

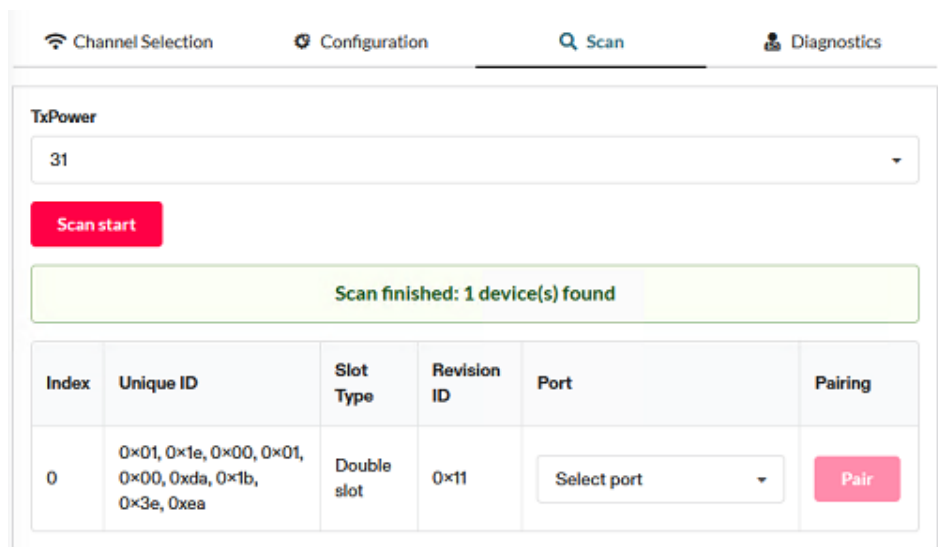

Figure 23: “Scan tab”, scan result

Parameter	Description	Value, Value range
Index	Device index	0 ... 20
Unique ID	Identification of the found IO-Link Device as unique ID (UUID, 9 Bytes).	Unique ID
Slot Type	Slot type of the found device	Single slot, Double slot
Revision ID	Revision ID of the device The revision ID indicates the IO-Link version supported by the IO-Link Device.	0: No device connected, 0x10: Device supports IO-Link version 1.0 0x11: Device supports IO-Link version 1.1
Port	Number of the wireless IO-Link port to which the IO-Link Device is to be paired. The page displays free ports only. Note: For a device featuring “Double slot” an <b>uneven</b> port has to be assigned.	WP01, WP02, WP03, ..., WP16 for single slot WP01, WP03, WP05, ..., WP15 for double slot



Parameter	Description	Value, Value range
Pairing	A pairing service is provided to pair a IO-Link Device to a wireless IO-Link port.	Pair (green), Remove (red)

Table 32: Scan result (pairing)

The page displays the scan result:

- In case of success: "Scan finished: [number of found devices] device(s) found".
- In case of a scan error: "Scan failed HTTP Error [error number]: [short description of error]".

### Pairing / Removing

For pairing an IO-Link Device to a wireless IO-Link port of the IO-Link Wireless Master:

- In the tab **Scan** within the scan result, select the **Port**. Any free port (WP01, WP02, ...) for single slot devices or any free port with an uneven number (WP01, WP03, ...) for double slot devices.
- Click **Pair**.
- ⇒ The message `Pairing successful` is displayed.

For removing an IO-Link Device from a wireless IO-Link port:

- Click **Remove** to remove an IO-Link Device from the wireless IO-Link port.
- ⇒ The message `Unpairing successful` is displayed.

For further information, refer to *Configuring the IO-Link Wireless Master* [▶ page 82].

### 8.3.6.4 Diagnostic

- Select **IO-Link Wireless Master** in the left column of the netFIELD Wireless Web Server.
- Open the **Diagnostics** tab.

Temperature [°C]	Current	Min	Max
Wireless Master Core	57	31	58
Wireless Track 1	57	56	58
Wireless Track 2	38	35	38
Wireless Track 3	39	36	39

Figure 24: Diagnostics tab

Use the Diagnostics tab, to display the diagnostics of wireless master and tracks temperatures.

Temperature	Description	Value, Value range
Wireless Master Core	Current, minimum and maximum temperatures of the wireless master core.	31 ... 58 C
Wireless Track 1	Current, minimum and maximum temperatures of the wireless track 1.	56 ... 58 C
Wireless Track 2	Current, minimum and maximum temperatures of the wireless track 2.	35 ... 38 C
Wireless Track 3	Current, minimum and maximum temperatures of the wireless track 3.	36 ... 39 C

Table 33: Diagnostics of wireless master and tracks temperatures

### 8.3.7 Port specific information and settings

In the port specific tabs Information, Status, Settings, ISDU, and Process Data, you can display device or port information individually for each of the wireless IO-Link ports of the IO-Link Wireless Master device. In the Settings tab you also can make port-specific settings, see *Port settings* [▶ page 63]. In the Pairing tab, you can pair, unpair or remove wireless devices for 16 ports. In the W-Bridge Update tab, you can update the firmware of a wireless bridge, respectively in the Device Update tab, you can update the firmware of an IO-Link wireless device, for max. 16 wireless target devices.

Access the tabs as follows:

- In the left-hand column of the netFIELD Wireless Web Server, click on the wireless IO-Link port **WP01**, **WP02**, **WP03**, ...
- The Information tab of the corresponding wireless IO-Link port appears.
- To open another port specific tab, click **Status**, **Settings**, **Pairing**, **W-Bridge Update**, **Device Update**, **ISDU**, or **Process Data**.

Tab	Description
Information	Displays some "Device information" of the IO-Link Device (Min cycle time, Function ID, Number of profile IDs, Vendor name, Vendor text, Product name, Product ID, Product text, Serial number, Hardware revision, Firmware revision).
Status	Displays port status information (Port state, Port quality, Revision ID, Master cycle time, Input data length, Output data length, Vendor ID, Device ID, Signal quality) and the quality status information. This tab shows current settings.
Settings	Display and setting of port parameters (Port mode, Validation and backup, Vendor ID, Device ID, Max PD segment length, Slot number, Track number, Device TX power, Max retry, W-Master cycle time out, W-Master cycle time in, Unique ID, Slot type, IMA time, Low energy device), see <i>Port settings</i> [▶ page 63]. This tab shows current settings.
Pairing	Pairing of new devices (pairing by button or by Unique ID)
W-Bridge Update	Firmware update of a wireless bridge.
Device Update	Firmware update of an IO-Link wireless device.
ISDU	Display of the Index Service Data Units: Read/write access to parameters of the connected IO-Link Device.
Process Data	Display of the process data (input/output)

Table 34: Port specific tabs

### 8.3.7.1 Device information

The Information tab displays some “Device information” of the IO-Link Device connected to a wireless IO-Link port. The official IO-Link SMI layer does not provide this information.

- In the left column of the netFIELD Wireless Web Server, select the wireless IO-Link port with the connected IO-Link Device.
- The **Information** tab appears with the device information of the connected device.

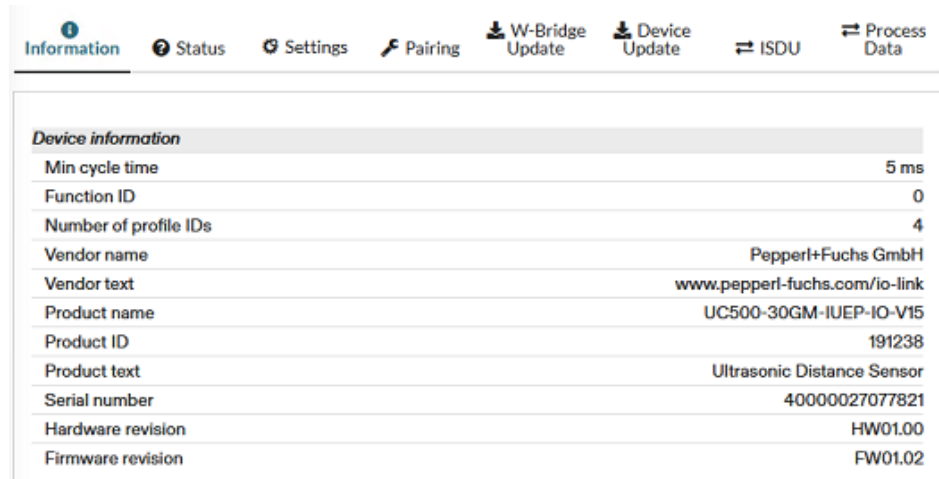

Figure 25: Information tab, Device information (example)

Parameters	Description	Value / Value range
Min cycle time	Minimum cycle duration supported by a Device. This is a performance feature of the Device and depends on its technology and implementation.	0 ... ms
Function ID	Function ID of connected device.	
Number of profile IDs	Provides the number of ProfileIDs contained in the ProfileCharacteristic (index 0x000D) of the connected device. The complete list the ProfileIDs has to be read using common OnRequestData Read mechanism.	
Vendor name	Detailed name of vendor of connected device.	Character string (up to 64 characters)
Vendor text	Additional vendor information of the connected device.	Character string (up to 64 characters)
Product name	Detailed product or type name of the connected device.	Character string (up to 64 characters)
Product ID	Product or type identification of connected device.	Character string (up to 64 characters)
Product text	Description of function or characteristic of connected device.	Character string (up to 64 characters)
Serial number	Vendor specific serial number of connected device.	Character string (up to 16 characters)
Hardware revision	Revision of hardware of connected device in a vendor specific format.	Character string (up to 64 characters)
Firmware revision	Revision of firmware in connected device in a vendor specific format.	Character string (up to 64 characters)

Table 35: Information tab, with Device information

### 8.3.7.2 Port status

- Select the wireless IO-Link port in the left column of the netFIELD Wireless Web Server.
- Open the **Status** tab.
- The current values for the status data of the selected wireless IO-Link port appear.

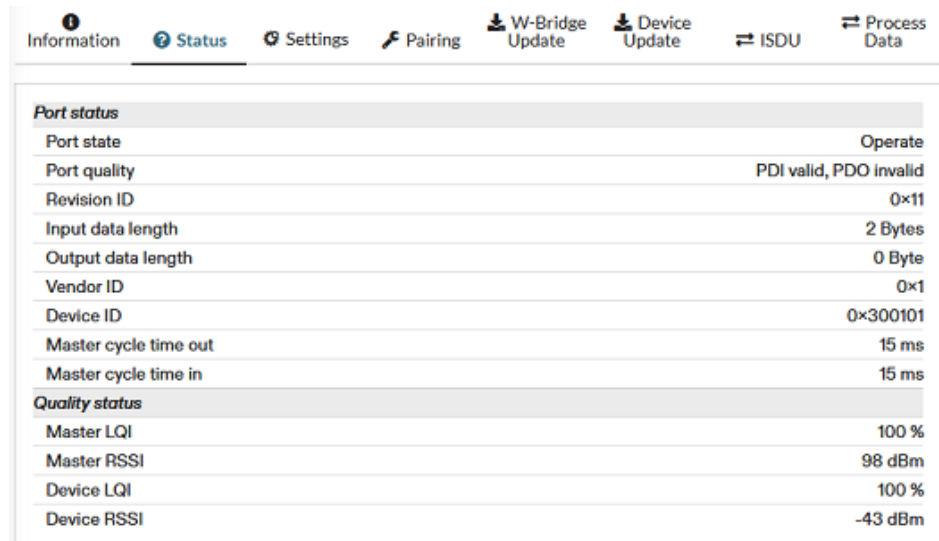

Figure 26: Status tab, Port status and Quality status (example)

The IO-Link port status holds the current port status.

Parameter	Description	Value, Value range
Port state	Current port state of wireless IO-Link port Descriptions of the possible values are listed in table <i>Port state values</i> [▶ page 62].	Pairing success, Pairing timeout, Pairing wrong slot type, Inactive, Port ready, Communication ready, Operate, Communication lost, Revision fault, Compatibility fault, Serial number fault, Process data fault, Cycle time fault
Port quality	Status information of process data Input process data is valid / not valid. Output process data is valid or not valid.	PDI valid, PDI invalid, PDO valid, PDO invalid
Revision ID	Revision ID Supported IO-Link version: V1.0 or V1.1.	10: V1.0 11: V1.1 0: No device connected
Input data length	Real input data length of connected device in bytes	0 ... 32
Output data length	Real output data length of connected device in bytes	0 ... 32
Vendor ID	Vendor ID	0 ... 0xFFFF, Default: 0
Device ID	Device ID	0 ... 0FFFFFFF, Default: 0
Master cycle time out	Cycle time of communication in operate mode The Master cycle time out is a Master parameter and displays the actual cycle time for data out. "Free running": The Minimum Master cycle time out is configured, based on the PD Segmentation length, Slot Type and Max Retry configurations.	"Free running", 5 ms ... 315 ms

Parameter	Description	Value, Value range
Master cycle time in	Cycle time of communication in operate mode The Master cycle time in is a Master parameter and displays the actual cycle time for data in. “Free running”: The Minimum Master cycle time in is configured, based on the PD Segmentation length, Slot Type and Max Retry configurations.	“Free running”, 5 ms ... 315 ms

Table 36: Port status

The following table contains the values for the port state:

Value	Description
Pairing success	Device is connected to the port via radio and there is wireless communication with the connected device.
Pairing timeout	A timeout has occurred for the connection from this port to the device.
Pairing wrong slot type	A wrong slot type is used for the connection from this port to the device.
Inactive	The port is inactive.
Port ready	The port is ready.
Communication ready	The device is ready for communication.
Operate	The device is in communication.
Communication lost	The communication to the device is broken down.
Revision fault	An error was found during revision check.
Compatibility fault	An error was found during compatibility check.
Serial number fault	An error was found during serial number check.
Process data fault	An error was found during process data check.
Cycle time fault	The configured cycle time does not match the connected device.

Table 37: Port state values

The **Quality status** object provides information about the current quality status of the W-Port. To maintain data consistency, only read access to the complete object is allowed.

Parameter	Description	Value, Value range
Master LQI	LQI calculated by W-Master (in percent)	Read only
Master RSSI	RSSI calculated by W-Master (in dBm)	Read only
Device LQI	LQI calculated by W-Device (in percent)	Read only
Device RSSI	RSSI calculated by W-Device (in dBm)	Read only

Table 38: Quality status

- The **Link Quality Indicator (LQI)** is a measure of the strength or quality of a received (radio) packet for Wireless Personal Area Networks (WPAN).
- The **Received Signal Strength Indicator (RSSI)** is an indicator for the received field strength of wireless communication applications.

### 8.3.7.3 Port settings

Use the Settings tab to view and change the port settings individually.

- Select the desired wireless port (WP01, WP02, WP03, ...) in the left column of the netFIELD Wireless Web Server.
- Open the **Settings** tab.
- The Port Mode sub tab appears by default.

#### Settings > Port Mode

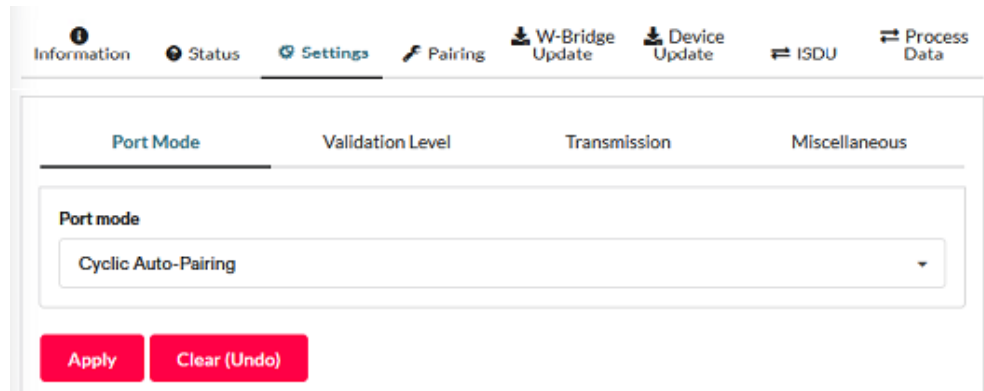

Figure 27: Settings tab, Port Mode sub tab (example)

Parameter	Description	Value / Value range
Port mode	Operating mode of IO-Link port <ul style="list-style-type: none"> <li>• Deactivated: The port is inactive, Input and Output Process Data is 0.</li> <li>• Cyclic with auto pairing</li> <li>• Cyclic without auto pairing (requires a separate paring step)</li> <li>• Roaming with auto pairing</li> <li>• Roaming without auto pairing (requires a separate paring step)</li> </ul>	Deactivated, Cyclic Auto-Pairing, Cyclic, Roaming Auto-Pairing, Roaming, Default: Deactivated

Table 39: Settings in port configuration for IO-Link Device, Port mode sub tab

\* Values are in hexadecimal format.

- Configure **Port mode** by selecting the corresponding port operating mode.

**Settings > Validation level**

- Open the **Validation level** sub tab.

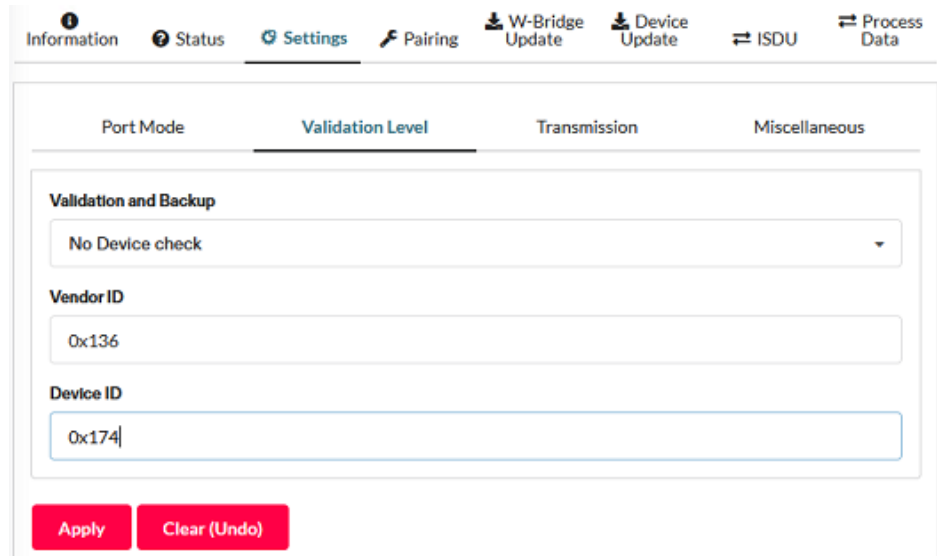

Figure 28: Settings tab, Validation level sub tab (example)

Parameter	Description	Value / Value range
Validation and backup	The table below contains descriptions for the possible values for the inspection level to be performed by the device and the Backup/Restore behavior:	Default: No device check
Vendor ID*	Expected Vendor ID of connected device This information is required to check the device for type compatibility.	0 ... 0xFFFF, Default: 0
Device ID*	Expected Device ID of connected device This information is required to check the device for type compatibility.	1 ... 0xFFFFFFFF, Default: 0xFFFFFFFF

Table 40: Settings in port configuration for IO-Link Device, Validation level sub tab

\* Values are in hexadecimal format.

- Under **Validation and backup**, configure possible values for the inspection level to be performed by the device and the Backup/Restore behavior.

Value	Description
No device check	There is no device check for validation of Revision, Vendor and Device IDs of connected IO-Link Devices (default).
Type compatible device V1.0	A device check is performed for validation of connected IO-Link Devices to the specified device type, without backup/restore.
Type compatible device V1.1	
Type compatible device V1.1, backup and restore	A device check is performed for validation or backup/restore of connected IO-Link Devices to the specified device type.
Type compatible device V1.1, restore	A device check is performed for validation or restore of connected IO-Link Devices to the specified device type,

Table 41: Validation and backup, possible values

- If necessary, set the expected port parameters Vendor ID and Device ID.



**Settings > Transmission**

➤ Open the **Transmission** sub tab.

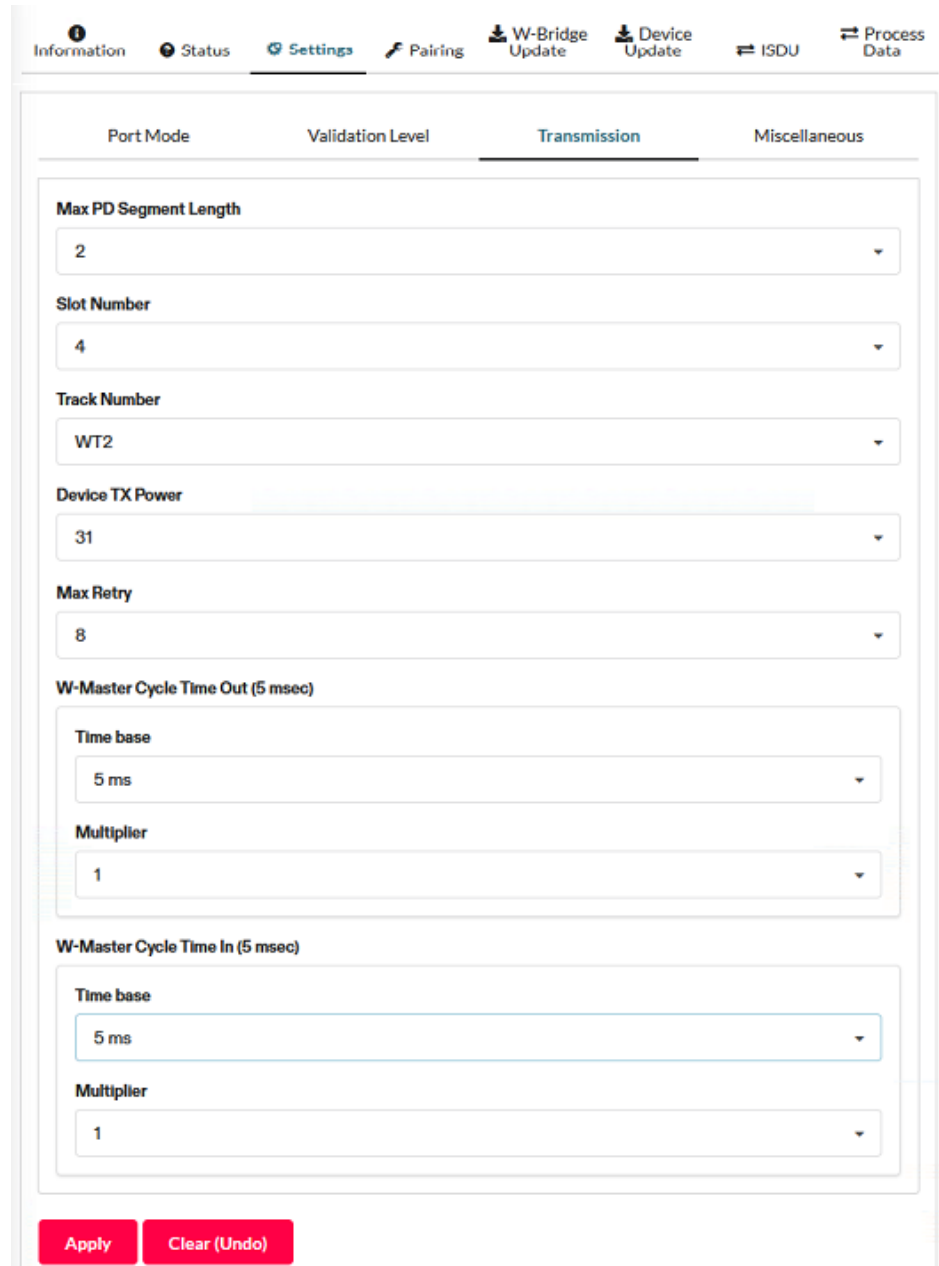

Figure 29: Settings tab, Transmission sub tab (example)

Parameter	Description	Value / Value range
Max PD Segment Length	This parameter contains the maximum segment length of the PDOOut data to the message handler to distribute PDOOut data within multiple wireless cycles. The maximum value depends by the actual transmission capacity of the used IO-Link Device.	1 ... 32 Byte, Default: 2
Slot number	Wireless slot number to be used for the port	0 ... 7, Default: 0
Track number	Wireless track number to be used for the port	WT1 (default), WT2, WT3
Device TX power	This parameter contains the transmit power level of the W-Device	1 ... 31, Default: 31
Max retry	Maximum number of retries for a transmission in OPERATE mode “Unknown” is indicated if there is no value available.	2 ... 31, Default: 8

Parameter	Description	Value / Value range
W-Master Cycle Time Out / W-Master Cycle Time In	W-Master cycle time out or W-Master cycle time in, expected by the SMI client	See table <i>Calculation of the W-Master cycle time of the IO-Link Wireless Master</i> [▶ page 66]
	The expected cycle time of the port is set depending on the selected operating parameters.	
	Time base: Used time base for the calculation of the port cycle time.	Free running, 5 ms
	Multiplier: Used factor for the calculation of the port cycle time if time base 5 ms has been selected (resulting in a port cycle time of 0...315 ms).	0 ... 63

Table 42: Settings in port configuration for IO-Link Device, Transmission sub tab

\* Values are in hexadecimal format.

- If necessary, set the expected port parameters Max PD Segment Length, Slot number, Track number, Device TX power or Max retry.
- Configure the “W-Master Cycle Time Out” or “W-Master Cycle Time In”.

Range of values	Time base (Bits 7+6)	Multiplier (Bits 5-0)	Resulting Cycle time
0	00	0	free-running mode
1 ... 64	00	1 ... 63	Note: If the free-running mode is chosen with a time base of 0, the W-Master stack will automatically configure the Master cycle time to be the Minimum Master cycle time based on the PD Segmentation length, Slot Type, and Max Retry configurations.
65 ... 127	01: 5ms (3 W-Sub-Cycles)	1 ... 63 as multiplier	5 ms ... 315 ms (Time Base * Multiplier), (3 to 189 W-Sub-Cycles) For value 65 the resulting cycle time is 5 ms, for value 66 the resulting cycle time is 10 ms, etc. Note: For W-Devices and W-Bridges the minimum possible transmission time is 5 ms.
128 ... 255	10 ... 11: reserved	1 ... 63	reserved, do not use

Table 43: Calculation of the W-Master cycle time of the IO-Link Wireless Master

The parameter “W-Master cycle time” is a W-Master parameter and sets up the actual cycle time of a particular W-Port. The cycle time is encoded using “Time base” (bits 6+7) and “Multiplier” (bits 0-5) values, as shown in the following table. The cycle time for the output data and input data can be set individually.

- Select the **Time base** and the **Multiplier** for the “W-Master Cycle Time Out” or “W-Master Cycle Time In” calculation.
- ⇒ The result is indicated as value or text in brackets, e. g. (Free running).

**Settings > Miscellaneous**

➤ Open the **Miscellaneous** sub tab.

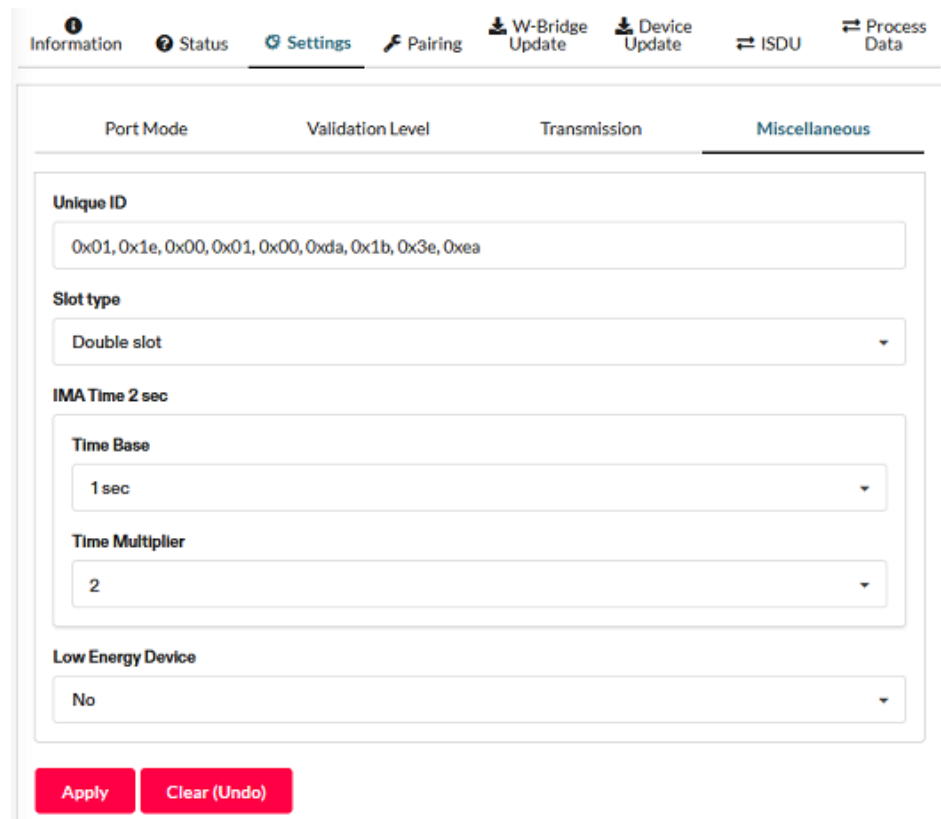

Figure 30: Settings tab, Miscellaneous sub tab (example)

Parameter	Description	Value / Value range
Unique ID*	Unique ID of the IO-Link Device (9 Bytes) Use the Unique ID (UUID) from the scan result.	0 ... 0xFF, Default: 0
Slot type	Slot type of the found device Use the slot type from the scan result. Note: For a device featuring “Double slot” an even number must be assigned as value for the slot.	Single slot, Double slot, Default: Double slot
IMA Time (calculated time)	Requested I-Am-Alive time for the OPERATE mode The I-Am-Alive time is calculated by multiplying the “time base” with the “time multiplier”.	1.664 ... 10 min (for higher values an error message appears), Default: 2 sec
	Time base: Used time base for the calculation of the I-Am-Alive time.	1.664 ms, 5 ms, 1 sec, 1 min
	Time multiplier: Used factor for the calculation of the I-Am-Alive time.	1 ... 255
Low energy device	Is the connected IO-Link Device a low energy device or not	No, Yes, Default: No

Table 44: Settings in port configuration for IO-Link Device, Miscellaneous sub tab

\* Values are in hexadecimal format.

- To configure the Unique ID, use the Unique ID (UUID) from the scan result.
- If necessary, set the expected port parameters Slot type or Low energy device.
- Configure the “IMA Time” (I-Am-Alive time).

The parameter "I-Am-Alive time" serves for W-Master and W-Device communication control if no other messages are transmitted. The W-Device has to send an "I-Am-Alive" messages to the W-Master before timeout, otherwise an error is reported, e.g. to start failsafe functionalities in the application.

The "I-Am-Alive time" is calculated by multiplying the "Time base" with the "Multiplier".

The Wireless Master verifies the calculated "I-Am-Alive time" with the following limits:

- Minimum I-Am-Alive time = W-Sub-cycle duration [ms] \* (MaxRetry + 1)  
If the calculated "I-Am-Alive time" is less than the "Minimum I-Am-Alive time", the Wireless Master uses the "Minimum I-Am-Alive time" as resulting "I-Am-Alive time".
  - Maximum I-Am-Alive time = 10 minutes  
If the calculated "I-Am-Alive time" is greater than the "Maximum I-Am-Alive time", the error message `Port configuration failed HTTP Error 500: NetProxy returned with an error: C0000124` appears.
- Select the **Time base** and the **Time multiplier** for the "IMA Time" calculation in order to avoid exceeding the maximum allowed value.
- The result is indicated as value in brackets.
- Click **Apply**.
- ⇒ Your changes now take effect. The message `Port configured successfully` appears and a green hook  appears for the selected port in the left column of the netFIELD Wireless Web Server, indicating that a connection from an IO-Link Device to this wireless IO-Link port has been established, and that the IO-Link Device is in "operate" state.

**Note:**

The green hook icon disappears if the IO-Link Wireless Master changes to an error state but the device connection is still established and in "connected" state (shown on top left corner of the netFIELD Wireless Web Server). If the device connection drops and the "disconnected" state is shown, the green hook icon is still visible and reflects the latest status obtained from the device.

---

### 8.3.7.4 Pairing

On the Pairing tab you can pair a wireless device (or a wireless bridge) that has not yet been scanned, i.e. whose unique ID is not yet known. Via the Pairing by button option unknown devices can be paired and replace the Unique ID.

#### Set port mode

- Select the wireless IO-Link port in the left column of the netFIELD Wireless Web Server.
- Open the **Settings** tab.
- Set the Port mode, as described in section *Port settings* [▶ page 63] or in section *Port settings for commissioning* [▶ page 84].

#### Switch to Pairing tab

- Open the **Pairing** tab.
- The Pairing tab appears as follows:

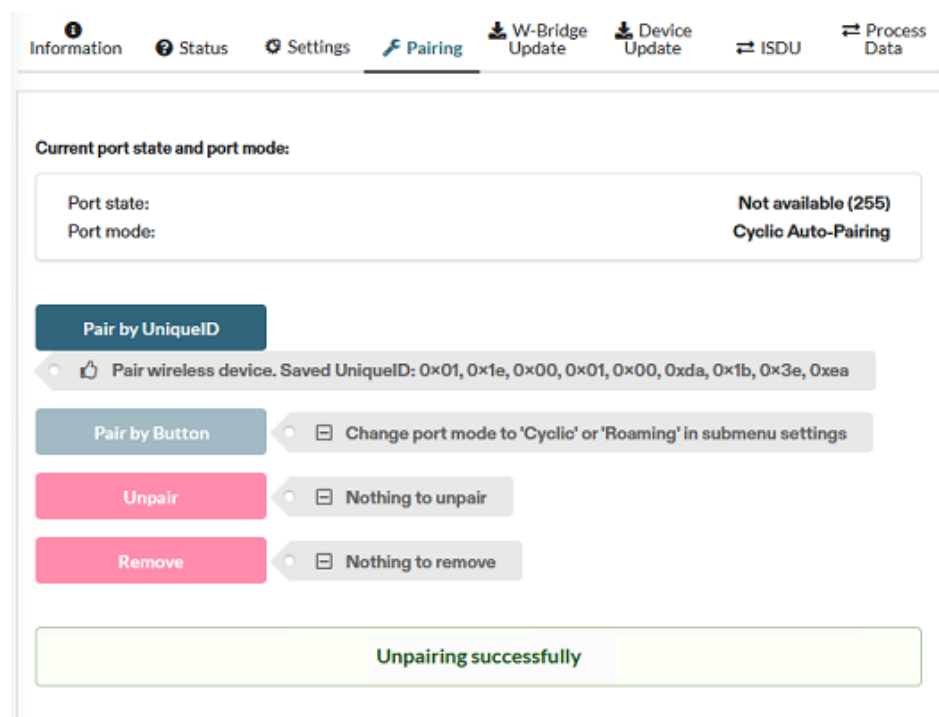

Figure 31: Pairing tab after port mode was set correctly

#### Pairing by button

- Now, press the button on the wireless device or on the bridge.
- Keep the button pressed at least for 5 seconds.
- Then, click **Pair by Button**.
- Keep the button (on the device or bridge) pressed at least for another three seconds.
- Wait for the message `Pairing successfully finished!`

### Pairing by Unique ID

- Make sure that you use the correct unique ID for the respective device. To do so, use the wireless device with the UniqueID that has been recognized with the last Scan or Pairing by button procedure. You also can add the correct UniqueID manually in the Settings > Miscellaneous tab (see section *Port settings* [▶ page 63]).
- Then, click **Pair by UniqueID**.

### Pairing successfully finished

- Wait for the message `Pairing successfully finished!`
- ⇒ The message `Pairing successfully finished!` appears:

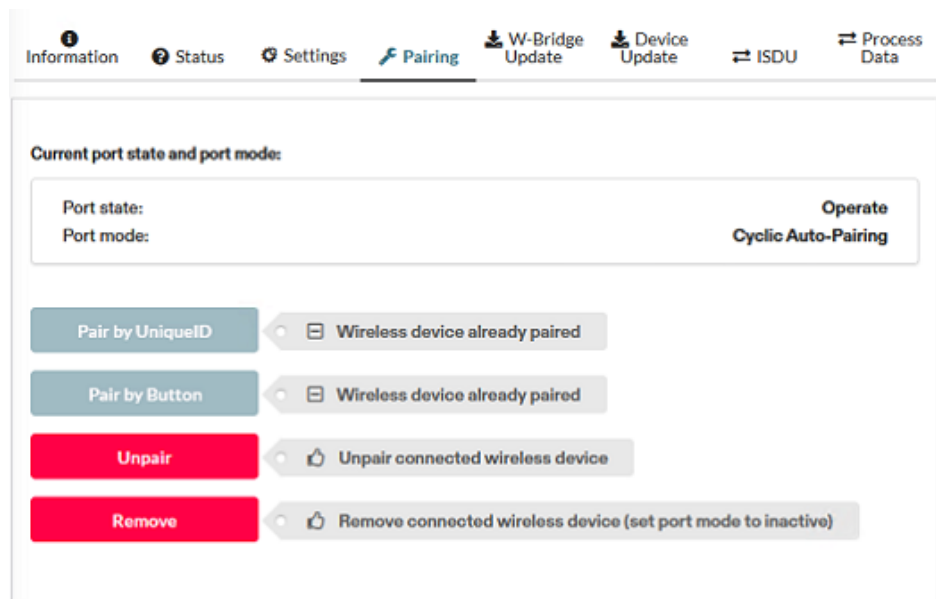

Figure 32: Pairing successfully finished

### Unpair device

- Click **UNPAIR**.
- ⇒ The connected wireless device is unpaired.

### Remove device

- Click **Remove**.
- ⇒ The connected wireless device is removed.
- ⇒ Port mode is set to `inactive`.

### 8.3.7.5 W-Bridge Update

The W-Bridge Update tab allows you to update the firmware of a wireless bridge. I. e., there are 16 different target devices for the firmware update. The W-Bridge Update runs via the wireless connection of the respective port.

#### Requirements

- The W-Bridge supports firmware update.
- The user has the role operator or administrator and has a connection established to the IO-Link Master device.
- The W-Bridge is connected to the port of the IO-Link Master.
- Firmware file is available.

#### Firmware files and formats

The Webserver supports the firmware file format:

- \*.zip (compressed archive file), provided by Hilscher

#### Safety instructions

---

##### **NOTICE**

#### **Bring the system in a fail-safe state before downloading a firmware**

Do not start a firmware download if the device is exchanging process data. A firmware download will stop the process data communication. A subsequent system stop may cause unpredictable behavior of machines and system components.

- Make sure that the device and all connected devices are in a fail-safe condition before you start a firmware download.

---

##### **NOTICE**

#### **Keep device powered during the firmware download**

If the power supply to the computer or device is interrupted while the firmware is being downloaded, the download will be aborted, the firmware may be corrupted, the device parameters may be lost, and the device may be damaged.

- During the firmware download process: Do not interrupt the power supply to the computer or to the device, and do not perform a reset to the device!



#### **Important:**

Backup your firmware and configuration data before you update the firmware of your device! Otherwise, you cannot restore the state of your device prior to the update, including the previously used firmware.

---

## Firmware update procedure (W-Bridge)

Proceed as follows:

- Select the wireless IO-Link port in the left column of the netFIELD Wireless Web Server.
- Open the **W-Bridge Update** tab.

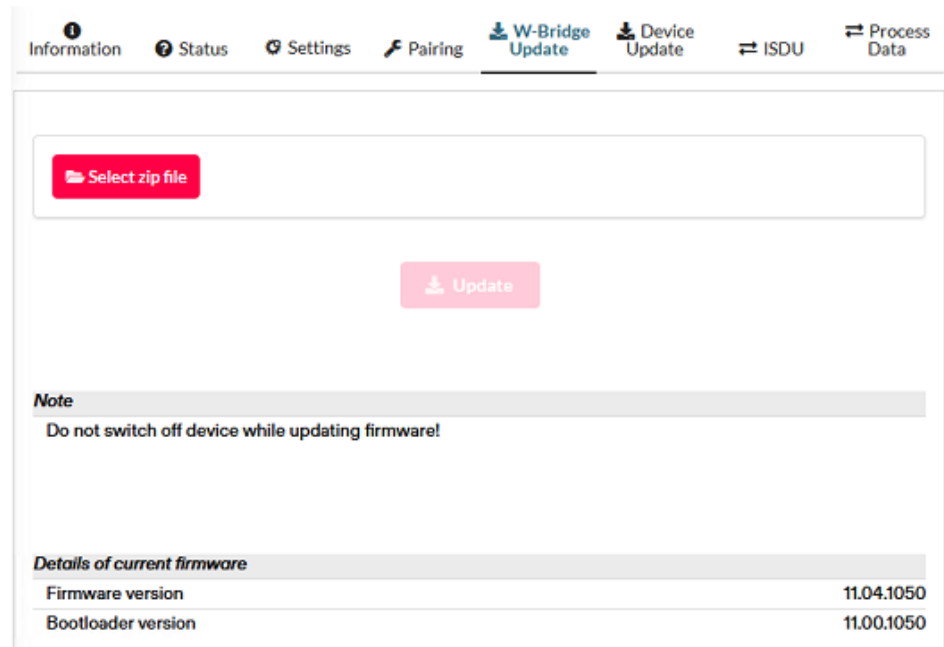

Figure 33: W-Bridge update tab (example)

- Click **Select zip file**.
- ⇒ A file selection dialog appears.
- Select the zip file in this dialog.
- Click **Update**.
- ⇒ The firmware update is performed. This takes a short while.



### 8.3.7.6 Device Update

The Device Update tab allows you to update the firmware of an IO-Link wireless device. I. e., there are 16 different target devices for the firmware update. The Device Update runs via the wireless connection of the respective port.

#### Requirements

- The IO-Link Device supports firmware updates via IO-Link.
- The user has the role operator or administrator and has a connection established to the IO-Link Master device.
- The IO-Link Device is connected to the port of the IO-Link Master.
- Firmware file is available.

#### Firmware files and formats

The Webserver supports the following firmware file formats:

- \*.iolfw (IO-Link firmware file)
- \*.zip (Compressed archive file)
- \*.7z (Compressed archive file 7zip)

#### Parameter comparison and compatibility check

After you have selected a firmware file, the app compares parameters (firmware version, vendor name, vendor ID, HW\_ID\_Key, product name, product ID) of the selected file with parameters of the firmware executed in the device. The app displays the comparison result with icons.

Icon	Parameter in firmware file and in device
Green hook	Parameter matches.
Orange cross	Minor mismatch. A firmware update is possible.
Red cross	Major mismatch caused by mismatching vendor ID or HW_ID_Key. Firmware file is not compatible with IO-Link Device. The Firmware update button is disabled.

Table 45: Icons of parameter comparison

The message `Cannot extract Firmware update image` shows that the selected file does not contain a firmware file.

#### Safety instructions

##### NOTICE

#### Bring the system in a fail-safe state before downloading a firmware

Do not start a firmware download if the device is exchanging process data. A firmware download will stop the process data communication. A subsequent system stop may cause unpredictable behavior of machines and system components.

- Make sure that the device and all connected devices are in a fail-safe condition before you start a firmware download.

**NOTICE**

**Keep device powered during the firmware download**

If the power supply to the computer or device is interrupted while the firmware is being downloaded, the download will be aborted, the firmware may be corrupted, the device parameters may be lost, and the device may be damaged.

- During the firmware download process: Do not interrupt the power supply to the computer or to the device, and do not perform a reset to the device!



**Important:**

Backup your firmware and configuration data before you update the firmware of your device! Otherwise, you cannot restore the state of your device prior to the update, including the previously used firmware.

**Firmware update procedure (Device)**

Proceed as follows:

- Select the wireless IO-Link port in the left column of the netFIELD Wireless Web Server.
- Open the **Device Update** tab.

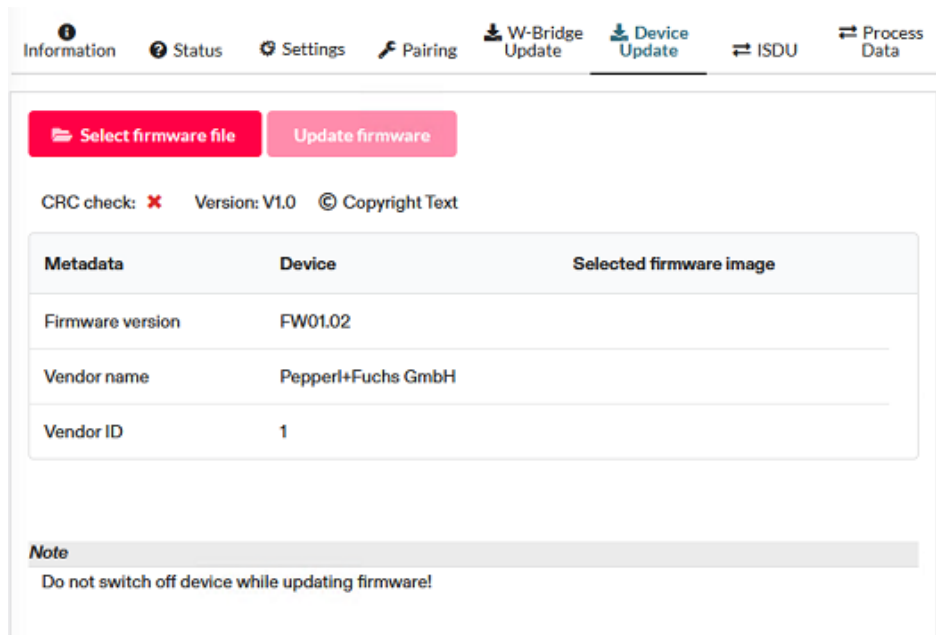

Figure 34: Device update tab (example)

- Click **Select firmware file**.
- A file selection dialog appears.
- In the file dialog, select the firmware file (file extension \*.iolfw, \*.zip, \*.7z).
- The version information of the selected firmware file and version information read from the IO-Link Device are displayed. You can verify the displayed version information to see whether the update is reasonable.

Parameters	Description
Firmware revision	Revision of firmware in connected device in a vendor specific format.
Vendor name	Detailed name of vendor of connected device.
Vendor ID	Vendor identification of connected device.

*Table 46: Metadata of the selected firmware*

- Click **Update firmware**.
- ⇒ The firmware update starts, and a progress bar appears.
- ⇒ The message `Firmware is successfully updated` appears.
- ⇒ The firmware update is performed. This takes a short while. The Metadata of the selected firmware are displayed.

### 8.3.7.7 Device ISDU

The ISDU tab allows read and write access to the IO-Link Device connected to a wireless IO-Link port by means of `Index` and `Subindex`. The ISDU message format is used for this.

The screenshot shows the ISDU tab interface with the following elements:

- Navigation bar: Information, Status, Settings, Pairing, W-Bridge Update, Device Update, **ISDU**, Process Data.
- Index (in hex):
- Subindex (in hex):
- Write data (in hex without spaces):
- Result format:
- Buttons: Read, Write, Clear History
- History list:
 

History list		
10:22:30	- 16:0	- Read OK: 0000
10:22:49	- 16:0	- Read OK: 00

Figure 35: Display of the On Request Data, read/write IO-Link Device parameters



For the meaning of the `Index` and `Subindex` values, refer to the documentation of the connected IO-Link Device. For a description of the ISDU message format, refer to the IO-Link specification.

#### Required rights

Changes to settings require operator or admin rights. If these are not available, the ISDU tab is grayed out and the displayed values cannot be edited.

#### Access to IO-Link Device

To access the data of an IO-Link Device connected to the selected wireless IO-Link port via `Index` and `Subindex` (ISDU message format):

- Select the wireless IO-Link port to which the IO-Link Device is connected in the menu on the left.
- Open the **ISDU** tab.
- The ISDU tab is displayed.

### Read access to IO-Link Device

To read data from the connected IO-Link Device, proceed as follows:

- Enter the `Index` for ISDU access as a hexadecimal value in the **Index** entry field.
- Enter the `Subindex` for ISDU access as a hexadecimal value in the **Subindex** entry field. The default value here is `00`.
- ↻ In case of input errors, an error message appears.
- Click on **Read**.
- ↻ The read access is executed. An entry with a time stamp is written to the history at the bottom of the ISDU tab.

If the execution was successful, the text `Read ok:` and the result is displayed in the history. The entries in the history then have the following structure:

```
Time - Index:Subindex - Read ok: <Result>
```

If the execution was not successful, an error message with error codes of the IO-Link Wireless Master and IO-Link Device is displayed in the history.

In this case, the entries in the history have the following structure:

```
Time - Index:Subindex - Read failed:
IOLMErrorCode(<error code of the IO-Link master>):
IOLDErrorCode(<error code of the IO-Link Device>)
```



Information on the meaning of the error codes of the IO-Link master (IOLMErrorCode) and device (IOLDErrorCode) can be found in the IO-Link specification.

The following applies in both cases:

- The `Time` is displayed in the format `HH:MM:SS`
- `Index` and `Subindex` are displayed in hexadecimal format.

### Write access to IO-Link Device

To write data to the connected IO-Link Device, proceed as follows:

- Enter the `Index` of the connected IO-Link Device that you want to access as a hexadecimal value in the **Index** entry field.
- Enter the `Subindex` of the connected IO-Link Device that you want to access as a hexadecimal value in the **Subindex** entry field. The default value here is `00`.
- ↻ In case of input errors, an error message appears.
- Enter the data to be written (in hexadecimal, without spaces, e.g., `0102030405`) in the **Write data** entry field.
- Click on **Write**.
- ↻ The write access is performed.

If the execution was successful, the text `Write ok:` and the result is displayed in the history. The entries in the history then have the following structure:

```
Time - Index:Subindex - Write ok: <Result>
```

If the execution was not successful, an error message with error codes of the IO-Link Wireless Master and IO-Link Device is displayed in the history. The entries in the history then have the following structure:

```
Time - Index:Subindex - Write failed:  
IOLMErrorCode(<error code of the IO-Link master>):  
IOLDErrorCode(<error code of the IO-Link Device>)
```

### **Delete the history of read and write accesses**

To clear the logged history of read and write accesses:

- Click **Clear history**.
- ⇒ The history of read and write accesses is deleted.

### 8.3.7.8 Port process data

You can display the process data belonging to a specific wireless IO-Link port using the Process data tab.

To display the process data for a port:

- Select the wireless IO-Link port in the left column of the netFIELD Wireless Web Server.
- Open the **Process data** tab.
- ⇒ The current values of process data configured for input or output are displayed in hexadecimal format under input or output.

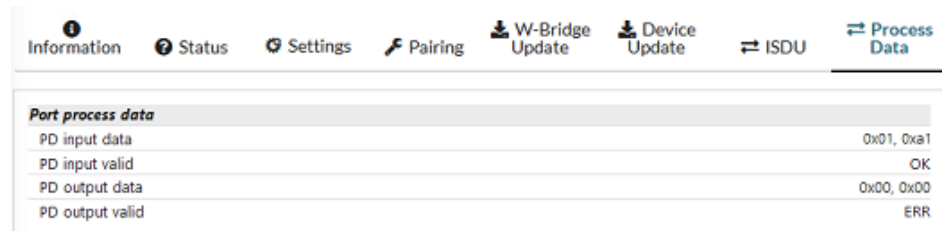

Figure 36: Display of the Port process data (example)

The Process Data tab shows the process data input and output values from and to a connected IO-Link Device:

Parameter	Description
PD input data	“Process Data” input data to the connected IO-Link Devices
PD input valid	Binary coded Port Qualifier for Input
PD output data	“Process Data” output data from the connected IO-Link Devices
PD output valid	Validation information for process data output. If Output Enable flag is set, data will be valid.

Table 47: Port process data, parameters

If no process data has been configured for a data direction (input or output), the corresponding field remains empty.

## 9 Commissioning

For commissioning the NFD-3090-EIS-IOLMW device using the netFIELD Wireless Web Server proceed as described in the sections hereafter.

### 9.1 Getting an IP address from a DHCP server

The device needs an IP address so that it can be addressed via the Ethernet network. In the state of delivery, the device does not have an IP address, and, once started, the device sends requests to a DHCP server in order to get an IP address.

If a DHCP server is already available in the network, ask your network administrator for the IP address assigned to the device and use its MAC address for identification.

If necessary, a static IP address can be set via the netFIELD Web Server. For details, see section *IP parameters* [▶ page 40].

#### Using a DHCP server on your PC

If no DHCP server exists in the network or if you wish to use a DHCP server in the local network for test purposes, you can use e.g. the Open DHCP server.

Observe the following notes:

- Never connect your PC to a global network, if a DHCP server is installed on your PC. Since larger networks usually have a DHCP server, collisions might occur causing a collapse of the network.
- Use a DHCP server on your PC only if no DHCP server is available in the network.

#### Installing and using the Open DHCP server

You can install the Open DHCP server on your PC. For configuring the DHCP server you need the IP address of the network connection of your PC. To display the IP address(es) of your PC, you can use the command `ipconfig` in the Windows command prompt.

Proceed as follows

- Download the Open DHCP server from <http://dhcpserver.sourceforge.net/>
- Install the Open DHCP server.
- Use a text editor to open file `OpenDHCPServer.ini` in the installation directory of the Open DHCP server.
- Under `[LISTEN_ON]`, enter the IP address of the PC network board on which the DHCP server is to work.
- Save file `OpenDHCPServer.ini`.
- Under `[RANGE_SET]`, enter the IP address range the DHCP server is allowed to assign.
- Thereafter, start file `RunStandAlone.bat`.
- ⇒ The DHCP server is ready for operation now.



In the output window the Open DHCP server displays the requests and the assigned IP address.

## 9.2 Configuration with netFIELD Wireless Web Server

### Requirements

To allow the commissioning or configuration using the netFIELD Wireless Web Server, the following requirements must be fulfilled:

- The device must be mounted, wired, and supplied with power.
- A browser is required, to connect to the netFIELD Wireless Web Server.
- A login as admin.

### 9.2.1 Configuring the IO-Link Wireless Master

- Select **IO-Link Wireless Master** in the left column of the netFIELD Wireless Web Server.
- On the **Channel selection** tab select the WLAN channels required (for example, WLAN channels 01 to 04).
- Then open the **Configuration** tab.

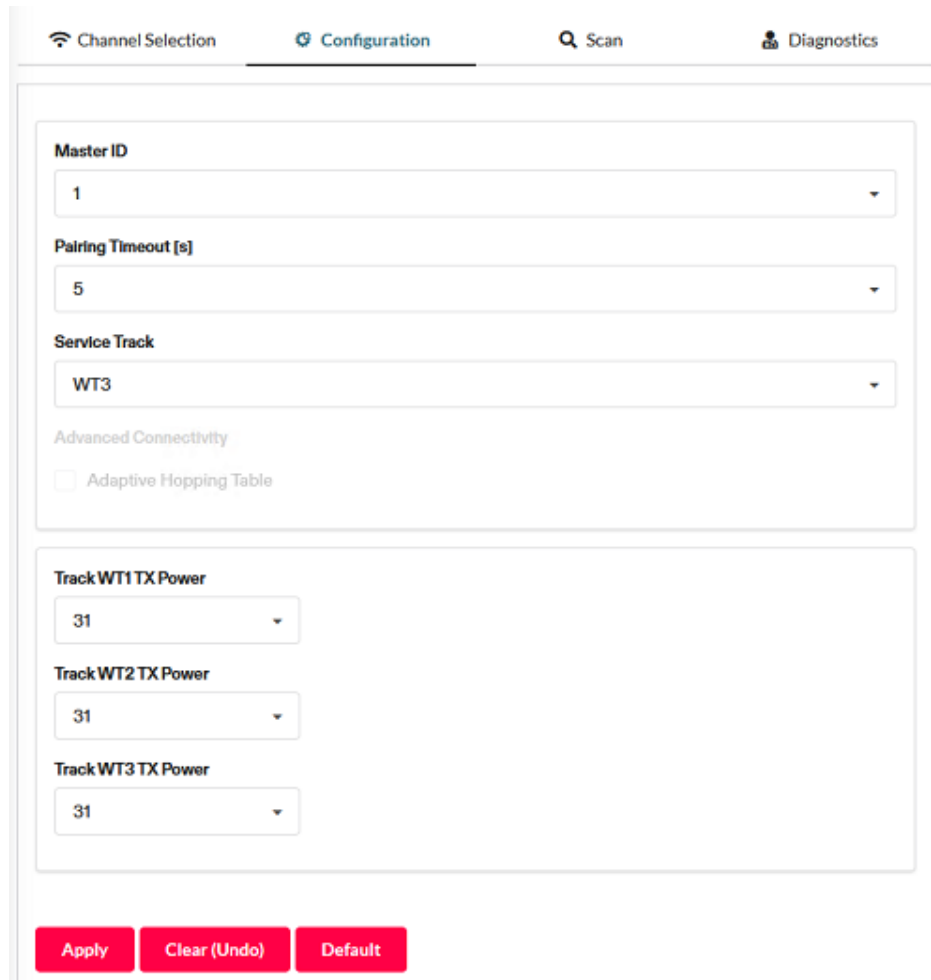

Figure 37: IO-Link Wireless Master > Configuration tab (example)

- Use the following IO-Link Wireless Master settings as possible values for commissioning. They will allow you to put the NFD-3090-EIS-IOLM \W device into operation.

Parameter	Possible value for commissioning	Note
Master ID	1	Enter the Master ID this way: "1"
Pairing Timeout	5	seconds
Service Track	WT3 (example)	-
WT1 TXPower	31	"31" = max. transmission power
WT2 TXPower	31	
WT3 TXPower	31	

Table 48: Configuration, possible values for IO-Link Wireless Master (example)

- Click **Apply**.
- The request appears Applying configuration will restart the device. Are you sure?.
- Click **Yes**.

- Wait until reset operation is finished and result is shown:
- The message `Master configured successfully` appears.
- The set IO-Link Wireless Master settings are used now.

**Scan**

- Select **IO-Link Wireless Master** in the left column of the netFIELD Wireless Web Server.
- Open the **Scan** tab.

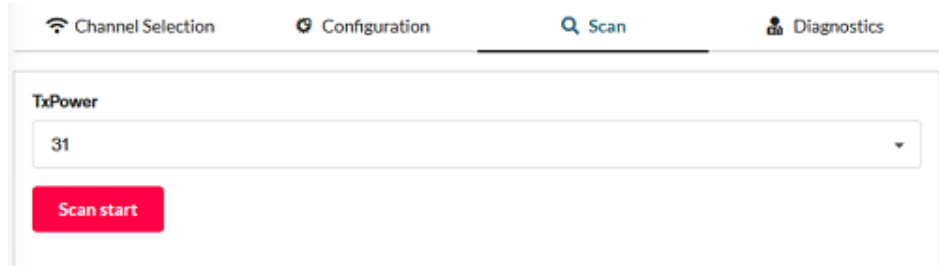

Figure 38: Scan tab

- Enter **TXPower** as decimal value: 31 (= maximum transmission power of the device)
- Click **Scan start**.
- The scan result is displayed. The connected device is found.

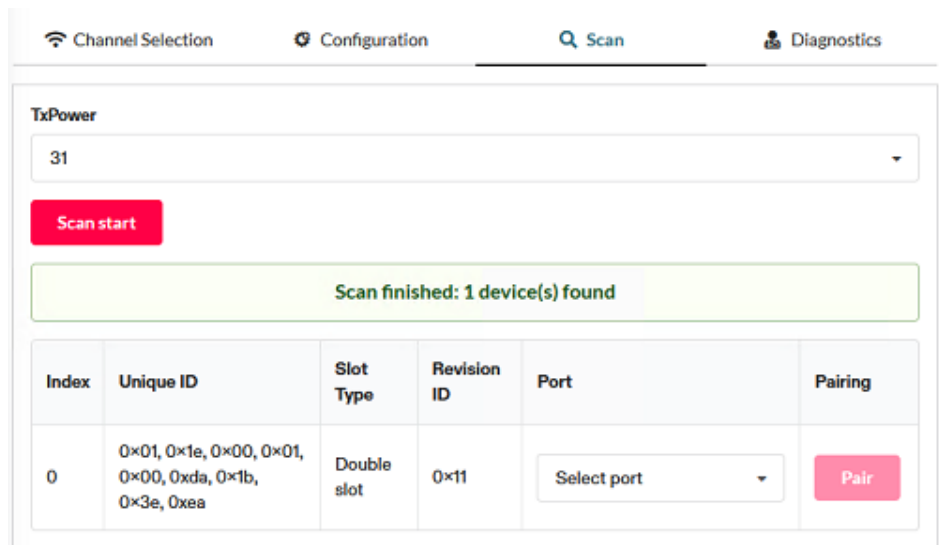

Figure 39: Scan tab with result

Parameter	Scan result (example)	Note
Index	0	
Unique ID	0x01,0x1e,0x00,0x01,0x00,0xda,0x1b,0x3e,0xea	Copy/note the unique ID. This value is required for port configuration.
Slot Type	Double slot	
Revision ID	0x11	
Port	“Select port”	Note: For a device featuring “Double slot” an even port must be assigned.
Pairing	Pair	

Table 49: Scan result values

## 9.2.2 Port settings for commissioning

- Select the desired wireless port (WP01, WP02, WP03, ...) in the left column of the netFIELD Wireless Web Server.
- Open the **Settings** tab with its sub tabs.
- The Port mode sub tab appears by default.



**Note:**

The values for the port settings given below are example values for commissioning of your NFD-3090-EIS-IOLMW device.

### “Port mode” sub tab

The Port mode sub tab includes the parameter Port mode.

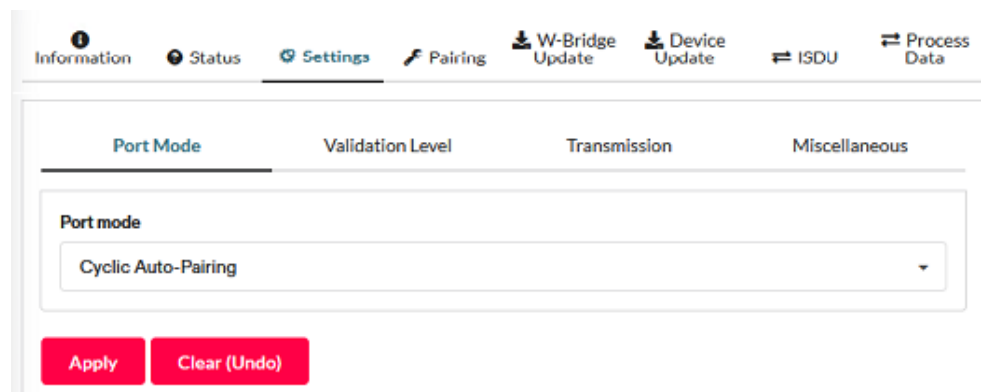

Figure 40: Settings tab > Port mode sub tab (example)

Parameter	Example value for commissioning	Note
Port mode	Cyclic Auto-Pairing	-

Table 50: Settings > Port mode (example values)

**“Validation level” sub tab**

- Click **Validation level**.
- The Validation level sub tab with the parameters Validation and backup, Vendor ID and Device ID appears.

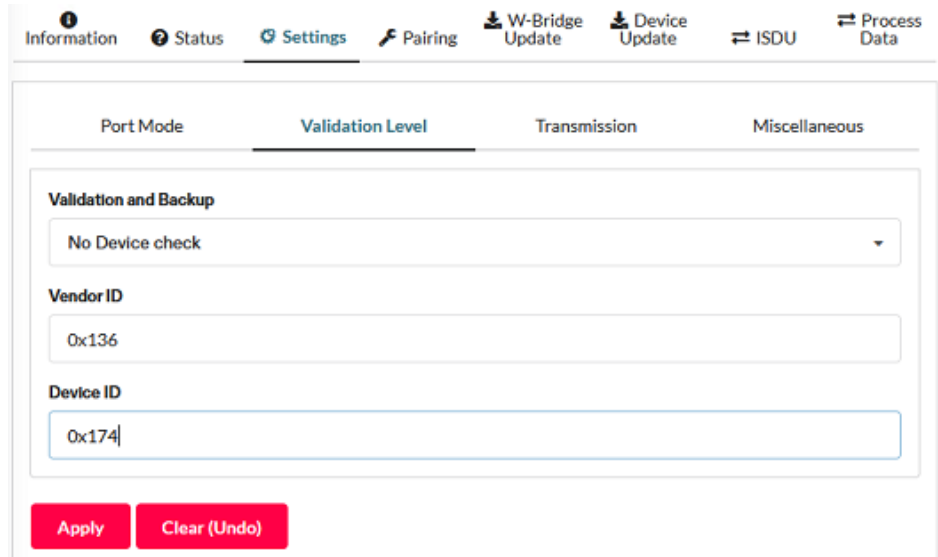

Figure 41: Settings tab > Validation level sub tab (example)

Parameter	Example value for commissioning	Note
Validation and backup	Default: No device check	
Vendor ID	0x0136	Example device
Device ID	0x0174	Example device

Table 51: Settings > Validation level (example values)

- Enter the **Vendor ID** and **Device ID** of the wireless connected IO-Link Device.

The Vendor ID and Device ID can be taken from the IODD or the device description of the manufacturer.

**“Transmission” sub tab**

- Click **Transmission**.
- The Transmission sub tab with the parameters Max PD Segment Length, Slot number, Track number, Device TX power and Max retry appears.

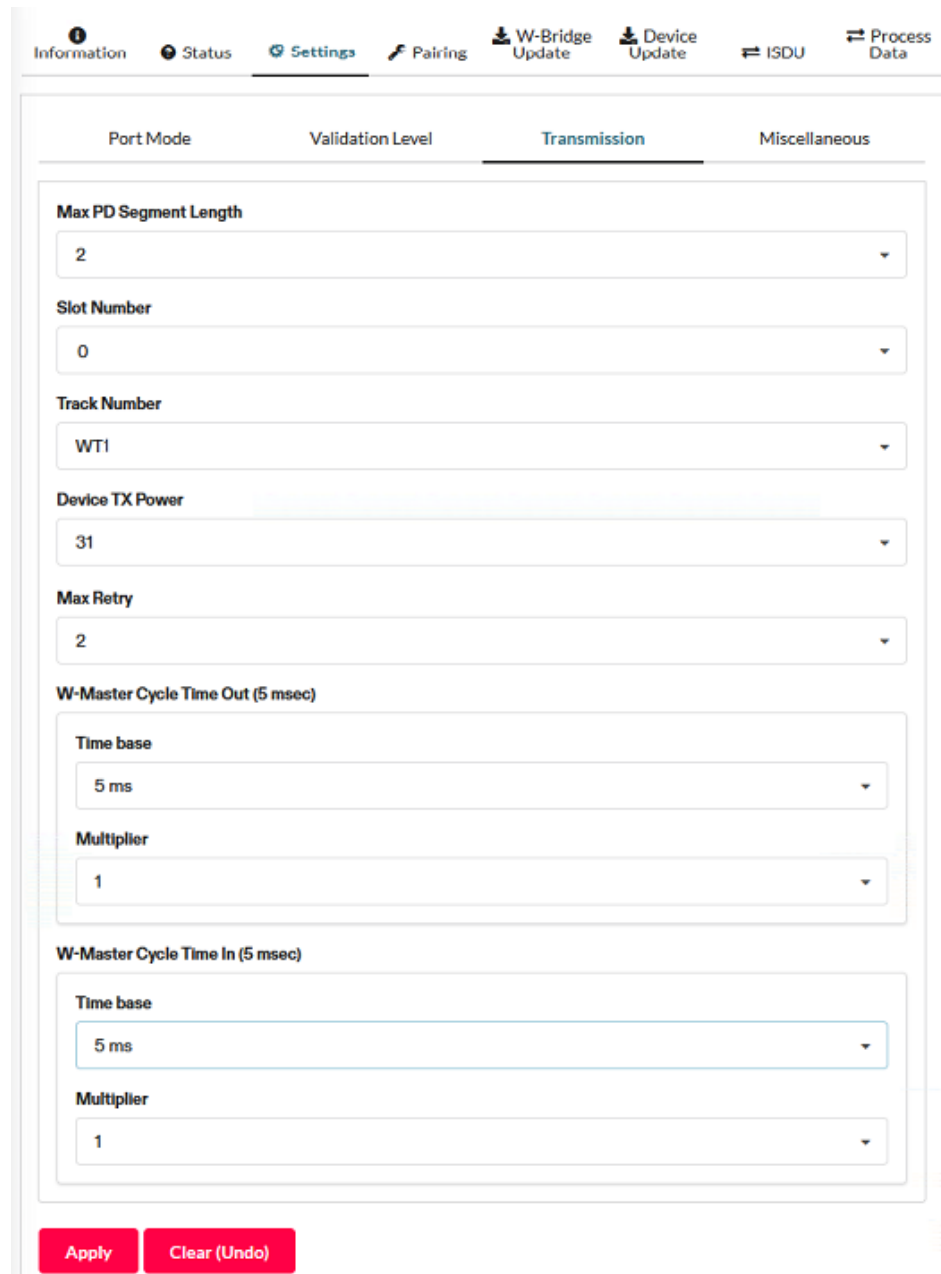

Figure 42: Settings tab > Transmission sub tab (example)

Parameter	Example value for commissioning	Note	
Maximum PD Segment Length	2	Max. process data transmissible via IO-Link, as in the example device used If this maximum value of the used device is not available, enter "32".	
Slot number	0		
Track number	WT1		
Device TX power	31	31 = max. transmission power	
Maximum retry	2	Example value	
W-Master Cycle Time Out / W-Master Cycle Time In	Time base	Multiplier	
Example 1	Free running	(any selectable value)	„Free running“
Example 2	5 ms	1	Port cycle time = 5 ms

Table 52: Settings > Transmission (example values)

**“Miscellaneous” sub tab**

- Click **Miscellaneous**.
- The Transmission sub tab with the parameters Unique I, Slot type, IMA Time 3 sec and Low energy device appears.

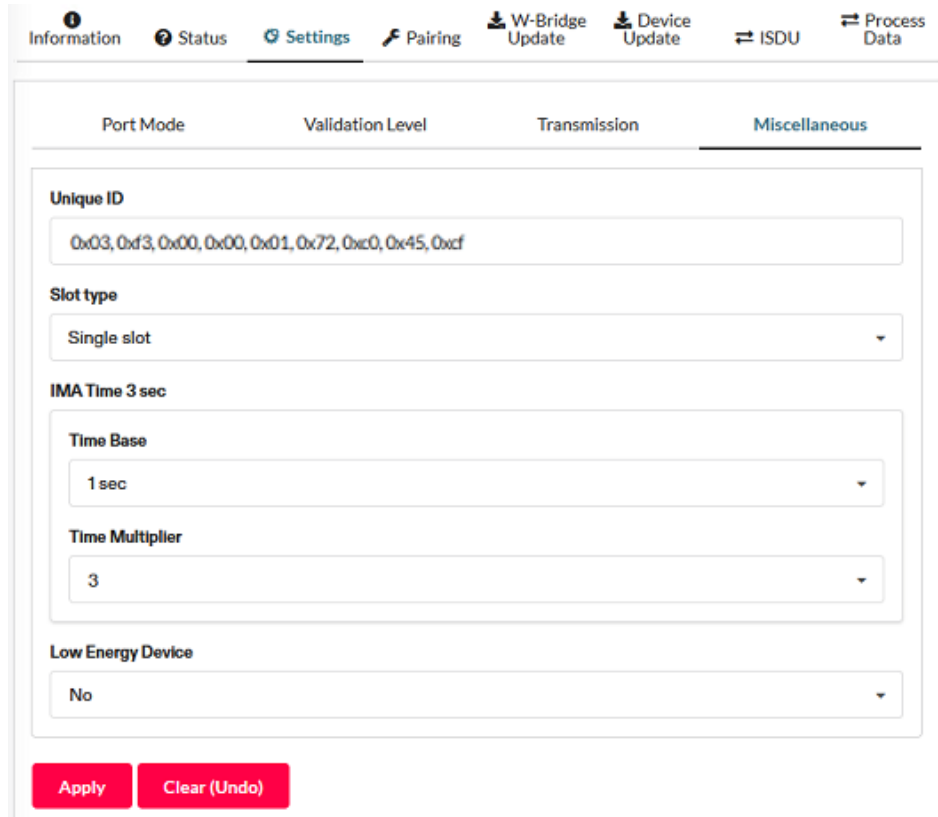

Figure 43: Settings tab > Miscellaneous sub tab (example)

Parameter	Example value for commissioning	Note
Unique ID	0x03,0xf3,0x00,0x00,0x01,0x72,0xc0,0x45,0xcf	The Unique ID consists of 9 numbers. Use the Unique ID from the scan result.
Slot type	Single slot	Use the slot type from the scan result. Note: For a device featuring “Double slot” an even number must be assigned as value for the slot.
IMA Time	Time base: 1 sec Time multiplier: 3	Default value is used
Low energy device	No	-

Table 53: Settings > Miscellaneous (example values)

- Enter the Unique ID numbers without space. Use the Unique ID from the scan result (see *Configuring the IO-Link Wireless Master* [▶ page 82]).
- Click **Apply**.

A description of the parameters on the sub tabs shown can be found under *Port settings* [▶ page 63]. For details on track and port, see *Wireless* [▶ page 92]. For the corresponding process data as result from the configuration made, see *Testing* [▶ page 88].

## 9.3 Testing

### Process data

- Select the desired wireless port (WP01, WP02, WP03, ...) in the left column of the netFIELD Wireless Web Server.
- Open the **Process Data** tab.
- The following process data are the result of the represented commissioning example with a laser distance sensor.

Port process data	
PD input data	0x01, 0xa1
PD input valid	OK
PD output data	0x00, 0x00
PD output valid	ERR

Figure 44: Tab and table “Port process data” (example PD input valid = OK)



**Note:**

Displayed values coming from a real sensor, can change if sensor conditions change.

### Status

- Select the desired wireless port (WP01, WP02, WP03, ...) in the left column of the netFIELD Wireless Web Server.
- Open the **Status** tab.
- The following port status data and quality status data show the values displayed after the configuration steps for the IO-Link Wireless Master and the port configuration are completed.

Port status	
Port state	Operate
Port quality	PDI valid, PDO invalid
Revision ID	0x11
Input data length	2 Bytes
Output data length	0 Byte
Vendor ID	0x1
Device ID	0x300101
Master cycle time out	15 ms
Master cycle time in	15 ms
Quality status	
Master LQI	100 %
Master RSSI	98 dBm
Device LQI	100 %
Device RSSI	-43 dBm

Figure 45: Status tab, Port status

The displayed values are real values from the device.



### Information

- Select the desired wireless port (WP01, WP02, WP03, ...) in the left column of the netFIELD Wireless Web Server.
- Open the **Information** tab.
- The following device information data are example values displayed after configuration steps for the IO-Link Wireless Master and the port configuration are completed.

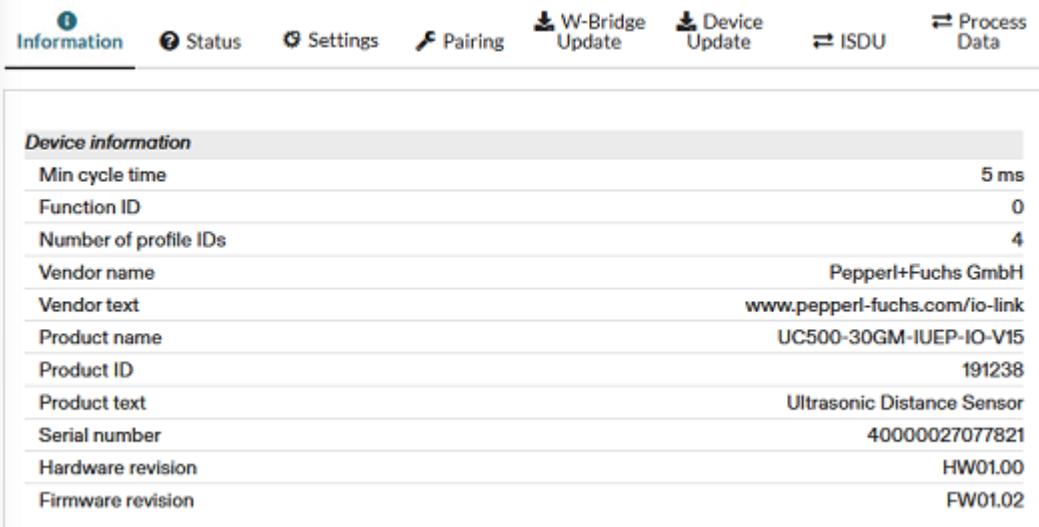

The screenshot shows the netFIELD Wireless Web Server interface. At the top, there is a navigation bar with several tabs: Information (selected), Status, Settings, Pairing, W-Bridge Update, Device Update, ISDU, and Process Data. Below the navigation bar, the 'Device information' section is displayed as a table with the following data:

Device information	
Min cycle time	5 ms
Function ID	0
Number of profile IDs	4
Vendor name	Pepperl+Fuchs GmbH
Vendor text	www.pepperl-fuchs.com/io-link
Product name	UC500-30GM-IUEP-IO-V15
Product ID	191238
Product text	Ultrasonic Distance Sensor
Serial number	40000027077821
Hardware revision	HW01.00
Firmware revision	FW01.02

Figure 46: Information tab, Device information

## 9.4 Master reset

To perform a reset of the IO-Link Wireless Master NFD-3090-EIS-IOLMW device, proceed as follows.

### 1. Safety

---

#### **NOTICE**

##### **Bring the system in a fail-safe state before downloading a firmware**

Do not start a firmware download while the system with the NFD-3090-EIS-IOLMW is in data exchange process. A firmware download will stop the process data communication. A subsequent system stop may cause unpredictable behavior of machines and system components.

- Make sure that the device and all connected devices are in a fail-safe condition before you start a firmware download.
- 

---

#### **NOTICE**

##### **Keep device powered during the firmware download**

If the power supply to the computer or device is interrupted while the firmware is being downloaded, the download will be aborted, the firmware may be corrupted, the device parameters may be lost, and the device may be damaged.

- During the firmware download process: Do not interrupt the power supply to the computer or to the device, and do not perform a reset to the device!
- 



#### **Important:**

Backup your firmware and configuration data before you update the firmware of your device! Otherwise, you cannot restore the state of your device prior to the update, including the previously used firmware.

---

### 2. Firmware update

- Select **Settings** in the left column of the netFIELD Wireless Web Server.
- Open the **Firmware update** tab.
- First click **Delete all settings**.
- Then click **Reset**.
- The device reset is complete. The message `Device reset successfully` appears.

For detailed descriptions on the firmware update page, see *Firmware update* [▶ page 42].

## 9.5 Indexed Service Data Units

### Read/write IO-Link Device parameters

The function of the ISDU tab is to read from or write to one IO-Link object of the connected IO-Link Device.

- Select **Master** in the left column of the netFIELD Wireless Web Server.
- Open the **ISDU** tab.
- ⇒ For example, you can read an IO-Link object from an IO-Link Device, e. g. to know the device manufacturer.

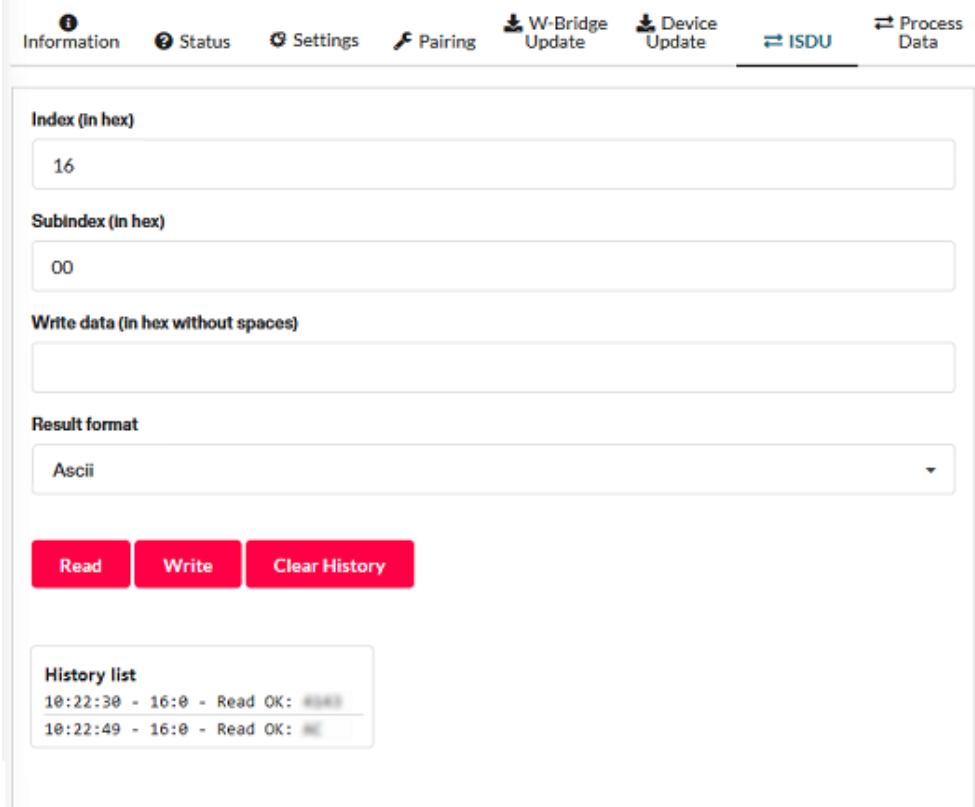

Information Status Settings Pairing W-Bridge Update Device Update **ISDU** Process Data

Index (In hex)  
16

SubIndex (In hex)  
00

Write data (In hex without spaces)

Result format  
Ascii

Read Write Clear History

History list  
10:22:30 - 16:0 - Read OK: 0000  
10:22:49 - 16:0 - Read OK: 00

Figure 47: ISDU tab, read/write IO-Link Device parameters

- To read data from the IO-Link Device click **Read**.
- ⇒ The time stamp and the corresponding data are displayed in ASCII format below.

For detailed descriptions on the ISDU tab, see *Device ISDU* [▶ page 76].

## 9.6 Wireless

For each track up to 8 IO-Link Devices can be connected via a wireless connection.

The tracks and slots for the IO-Link Devices, configured with the wireless IO-Link port configuration, must be unique! For each connected IO-Link Device, 1 wireless track must be configured and 1 slot must be configured.

The presented commissioning example includes 1 connected IO-Link Device. The chosen values were:

- Track: 0x00
- Slot: 0x00

Any further slots must be configured to free slots.



### Note:

If slot type = "Double slot", then the value for slot must be an even number.

The following table shows an example for track and slot configuration for a connected IO-Link Device if the slot type "Double slot" is configured.

Track	Slot 0	Slot 1	Slot 2	Slot 3	Slot 4	Slot 5	Slot 6	Slot 7
0	W-device with double slot	free	free	free	free	free	free	free
1	free	free	free	free	free	free	free	free

Table 54: Track and Slot – example 1 wireless device with slot type "double slot"

## 9.7 Setting date and time

The device has a built-in timing unit. To get the date and time from an NTP server using Network Time Protocol (NTP), the device needs the IP address of the NTP server. An OPC UA client is required to set the IP address of the NTP server.

Chapter *NTP Client configuration* [▶ page 112] describes the nodes of the OPC UA server for configuring the NTP client.

Chapter *Setting date and time of the device via OPC UA* [▶ page 95] describes how to set the IP address of the NTP server via an OPC UA client.

## 9.8 Using OPC UA Client

The device has an integrated OPC UA server. You can communicate with the device using an OPC UA client.

For test purposes, you can use e.g. the UaExpert from Unified Automation GmbH:

<http://www.unifiedautomation.com>

The authentication "anonymous" allows an OPC UA client read access to the device.

The authentication "User name and password" allows an OPC UA client read access and write access to the device if the user used has the permission to write.

### 9.8.1 Connecting with device

#### Requirements

- You have an OPC UA client.
- For write access to the device: You know the user name and password, and you have the permission to write.
- You know the IP address of the device.

Without user name and password, you can access the device "anonymously" and read data.

#### Step-by-step instructions

Establish a connection to the device:

- Start UaExpert.
- Use **File > New** to create a new project.
- Use **Server > Add** to add a new server.
- The tab **Discovery** displays the dialog **Add Server**.

Tab **Discovery** (default)

Tab **Advanced**

Table 55: Dialog Add Server - tabs **Discovery** and **Advanced**

- In the field **Configuration name**, enter a name for your configuration, e. g. `Test`.
- Select the tab **Advanced**.
- In the area **Server Information** of the tab **Advanced**, enter the following text in the data field **Endpoint Url**:  
`opc.tcp://<IP address>:4840`  
 For `<IP address>` enter the IP address of your device.
- In the area **Authentication Settings**, select the option **Username/Password** if you want to execute a write access to the device or select **Anonymous** if a read access is sufficient.
- If you have selected the option **Username/Password**, enter your user name and, if necessary, your password.
- Click **Ok**.
- ⇒ In the project window, under **Project > Servers**, the UaExpert enters the server, e. g. `Test`.
- Open the context menu of the server (`Test`) and select **Connect**.
- ⇒ The connection will be established.

## 9.8.2 Setting date and time of the device via OPC UA

### Requirements

- You have an OPC UA client.
- You know the username and password, and you have the permission to write.
- You know the IP address of an NTP server.
- You have converted the IP address of the NTP server into a decimal number, as described below.
- You have already established a connection to the device.

### Example of an NTP server

NTP server `ptbtime1.ptb.de` of the German Federal Institute of the Physikalisch-Technische Bundesanstalt in Braunschweig with the IP address `192.53.103.108`

Substitute NTP server (optional) of the NTP server `ptbtime2.ptb.de` of the Physikalisch-Technische Bundesanstalt in Braunschweig with the IP address `192.53.103.104`

### Converting an IP address into a decimal number

To convert the IP address to a decimal number, use the following formula. Starting from an IP address in the format `A.B.C.D`:

$$((A * 256 + B) * 256 + C) * 256 + D = \text{IP address as a decimal number}$$

Example of IP address `192.53.103.108`

$$((192 * 256 + 53) * 256 + 103) * 256 + 108 = 3224725356$$

### Step-by-step instructions

- In the window **Address Space**, open the context menu:  
`Root> Objects> DeviceSet> [Device name] >`  
`Configuration> NtpClient>`  
`NtpClientUpdateConfiguration.`

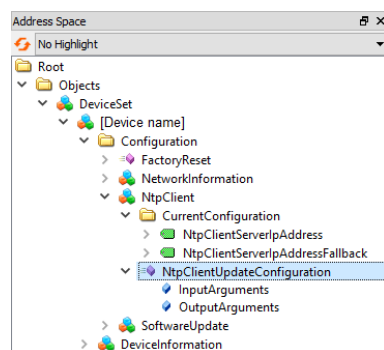

Figure 48: Node `NtpClientUpdateConfiguration` (1)

- In the context menu select **Call**.

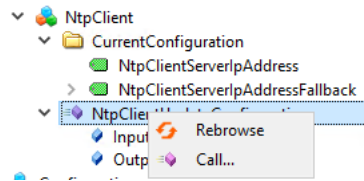

Figure 49: Node NtpClientUpdateConfiguration (2)

- The dialog **Call NtpClientUpdateConfiguration on NtpClient** will be displayed:

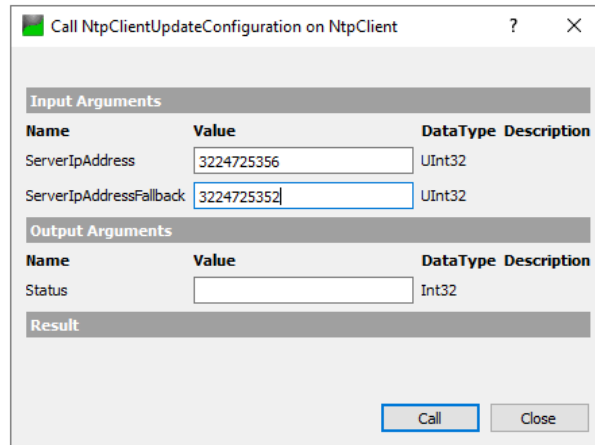

Figure 50: Dialog for configuring the NTP client

- In the area **Input Arguments**, in the input field **ServerIpAddress**, enter the value 3224725356 for the IP address of the NTP server.
- In the area **Input Arguments**, in the input field **ServerIpAddressFallback**, enter 3224725352 for the IP address of the substitute NTP server.
- Click **Call**.
- ⇒ If the function call was successful, the output field to the right of Status in the area **Output Arguments** displays 0. A green bar with the text "succeeded" appears in the area **Result**. The two variables ServerIpAddress and ServerIpAddressFallback are now set. Via NTP the device gets the current date and time of the time server and synchronizes its internal timing unit.

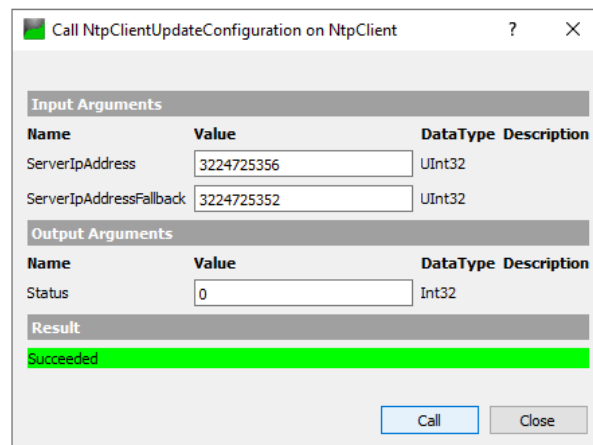

Figure 51: Dialog for configuring the NTP client (successful)



## 10 Communication

### 10.1 Process data

This section describes the process data for the netFIELD IO-Link Wireless Master EtherNet/IP Adapter NFD-3090-EIS-IOLM/W

- Connection 1 (Exclusive Owner - 8 ports x 32 bytes)
- Connection 2 (Exclusive Owner - 8 ports x 32 bytes w/o Config)
- Connection 3 (Listen Only - 8 ports x 32 bytes)
- Connection 4 (Input Only - 8 ports x 32 bytes)
- Connection 5 (Exclusive Owner - 16 ports x 16 bytes w/o Config)
- Connection 6 (Listen Only - 16 ports x 16 bytes)
- Connection 7 (Input Only - 16 ports x 16 bytes)
- Connection 8 (Exclusive Owner - 16 ports x 4 bytes w/o Config)
- Connection 9 (Listen Only - 16 ports x 4 bytes)
- Connection 10 (Input Only - 16 ports x 4 bytes)

The process data input and the process data output

- for connection 1, connection 2, connection 3 and connection 4 have a fixed size of 276 Byte,
- for connection 5, connection 6 and connection 7 have a fixed size of 292 Byte,
- for connection 8, connection 9 and connection 10 have a fixed size of 100 Byte.

## 10.1.1 Connections 1 to 4

### Input process data

The following table gives a description of the process data structure of the input process data and is valid for connection 1, connection 2, connection 3 and connection 4.

Byte	Number of bytes	Input process data	Description
1	1 byte	DI status	Reserved
2	1 byte	Padding byte	Do not use
3 ... 4	2 byte	DI data	Reserved
5	1 byte	WP01 data status	See section <i>Input process data status</i> [▶ page 109].
6	1 byte	Padding byte	Do not use
7 ... 38	32 byte	WP01 process input data	IO-Link input data of the IO-Link Device wireless connected to WP01. For a description of the data, see manual of the manufacturer of the used IO-Link Device.
39	1 byte	WP02 data status	See section <i>Input process data status</i> [▶ page 109].
40	1 byte	Padding byte	Do not use
41 ... 72	32 byte	WP02 process input data	IO-Link input data of the IO-Link Device wireless connected to WP02. For a description of the data, see manual of the manufacturer of the used IO-Link Device.
73	1 byte	WP03 data status	See section <i>Input process data status</i> [▶ page 109].
74	1 byte	Padding byte	Do not use
75 ... 106	32 byte	WP03 process input data	IO-Link input data of the IO-Link Device wireless connected to WP03. For a description of the data, see manual of the manufacturer of the used IO-Link Device.
107	1 byte	WP04 data status	See section <i>Input process data status</i> [▶ page 109].
108	1 byte	Padding byte	Do not use
109 ... 140	32 byte	WP04 process input data	IO-Link input data of the IO-Link Device wireless connected to WP04. For a description of the data, see manual of the manufacturer of the used IO-Link Device.
141	1 byte	WP05 data status	See section <i>Input process data status</i> [▶ page 109].
142	1 byte	Padding byte	Do not use
143 ... 174	32 byte	WP05 process input data	IO-Link input data of the IO-Link Device wireless connected to WP05. For a description of the data, see manual of the manufacturer of the used IO-Link Device.
175	1 byte	WP06 data status	See section <i>Input process data status</i> [▶ page 109].
176	1 byte	Padding byte	Do not use
177 ... 208	32 byte	WP06 process input data	IO-Link input data of the IO-Link Device wireless connected to WP06. For a description of the data, see manual of the manufacturer of the used IO-Link Device.
209	1 byte	WP07 data status	See section <i>Input process data status</i> [▶ page 109].
210	1 byte	Padding byte	Do not use
211 ... 242	32 byte	WP07 process input data	IO-Link input data of the IO-Link Device wireless connected to WP07. For a description of the data, see manual of the manufacturer of the used IO-Link Device.
243	1 byte	WP08 data status	See section <i>Input process data status</i> [▶ page 109].
244	1 byte	Padding byte	Do not use

Byte	Number of bytes	Input process data	Description
245 ... 276	32 byte	WP08 process input data	IO-Link input data of the IO-Link Device wireless connected to WP08. For a description of the data, see manual of the manufacturer of the used IO-Link Device.

Table 56: Input process data, connection 1 to connection 4

### Output process data

The following table gives a description of the process data structure of the output process data and is valid for connection 1 and connection 2.

Byte	Number of bytes	Output process data	Description
1	1 byte	DO status	Reserved
2	1 byte	Padding byte	Do not use
3 ... 4	2 byte	DO data	Reserved
5	1 byte	WP01 Output enable	0: WP01 output data not valid. 1-255: WP01 output data valid.
6	1 byte	Padding byte	Do not use
7 ... 38	32 byte	WP01 process output data	IO-Link output data of the IO-Link Device wireless connected to WP01. For a description of the data, see manual of the manufacturer of the used IO-Link Device.
39	1 byte	WP02 Output enable	0: WP02 output data not valid. 1-255: WP02 output data valid.
40	1 byte	Padding byte	Do not use
41 ... 72	32 byte	WP02 process output data	IO-Link output data of the IO-Link Device wireless connected to WP02. For a description of the data, see manual of the manufacturer of the used IO-Link Device.
73	1 byte	WP03 Output enable	0: WP03 output data not valid. 1-255: WP03 output data valid.
74	1 byte	Padding byte	Do not use
75 ... 106	32 byte	WP03 process output data	IO-Link output data of the IO-Link Device wireless connected to WP03. For a description of the data, see manual of the manufacturer of the used IO-Link Device.
107	1 byte	WP04 Output enable	0: WP04 output data not valid. 1-255: WP04 output data valid.
108	1 byte	Padding byte	Do not use
109 ... 140	32 byte	WP04 process output data	IO-Link output data of the IO-Link Device wireless connected to WP04. For a description of the data, see manual of the manufacturer of the used IO-Link Device.
141	1 byte	WP05 Output enable	0: WP05 output data not valid. 1-255: WP05 output data valid.
142	1 byte	Padding byte	Do not use
143 ... 174	32 byte	WP05 process output data	IO-Link output data of the IO-Link Device wireless connected to WP05. For a description of the data, see manual of the manufacturer of the used IO-Link Device.
175	1 byte	WP06 Output enable	0: WP06 output data not valid. 1-255: WP06 output data valid.
176	1 byte	Padding byte	Do not use
177 ... 208	32 byte	WP06 process output data	IO-Link output data of the IO-Link Device wireless connected to WP06. For a description of the data, see manual of the manufacturer of the used IO-Link Device.
209	1 byte	WP07 Output enable	0: WP07 output data not valid. 1-255: WP07 output data valid.
210	1 byte	Padding byte	Do not use

Byte	Number of bytes	Output process data	Description
211 ... 242	32 byte	WP07 process output data	IO-Link output data of the IO-Link Device wireless connected to WP07. For a description of the data, see manual of the manufacturer of the used IO-Link Device.
243	1 byte	WP08 Output enable	0: WP08 output data not valid. 1-255: WP08 output data valid.
244	1 byte	Padding byte	Do not use
245 ... 276	32 byte	WP08 process output data	IO-Link output data of the IO-Link Device wireless connected to WP08. For a description of the data, see manual of the manufacturer of the used IO-Link Device.

*Table 57: Output process data, connection 1 and connection 2*

## 10.1.2 Connections 5 to 7

### Input process data

The following table gives a description of the process data structure of the input process data and is valid for connection 5, connection 6 and connection 7.

Byte	Number of bytes	Input process data	Description
1	1 byte	DI status	Reserved
2	1 byte	Padding byte	Do not use
3 ... 4	2 byte	DI data	Reserved
5	1 byte	WP01 data status	See section <i>Input process data status</i> [▶ page 109].
6	1 byte	Padding byte	Do not use
7 ... 22	16 byte	WP01 process input data	IO-Link input data of the IO-Link Device wireless connected to WP01. For a description of the data, see manual of the manufacturer of the used IO-Link Device.
23	1 byte	WP02 data status	See section <i>Input process data status</i> [▶ page 109].
24	1 byte	Padding byte	Do not use
25 ... 40	16 byte	WP02 process input data	IO-Link input data of the IO-Link Device wireless connected to WP02. For a description of the data, see manual of the manufacturer of the used IO-Link Device.
41	1 byte	WP03 data status	See section <i>Input process data status</i> [▶ page 109].
41	1 byte	Padding byte	Do not use
43 ... 58	16 byte	WP03 process input data	IO-Link input data of the IO-Link Device wireless connected to WP03. For a description of the data, see manual of the manufacturer of the used IO-Link Device.
59	1 byte	WP04 data status	See section <i>Input process data status</i> [▶ page 109].
60	1 byte	Padding byte	Do not use
61 ... 76	16 byte	WP04 process input data	IO-Link input data of the IO-Link Device wireless connected to WP04. For a description of the data, see manual of the manufacturer of the used IO-Link Device.
77	1 byte	WP05 data status	See section <i>Input process data status</i> [▶ page 109].
78	1 byte	Padding byte	Do not use
79 ... 94	16 byte	WP05 process input data	IO-Link input data of the IO-Link Device wireless connected to WP05. For a description of the data, see manual of the manufacturer of the used IO-Link Device.
94	1 byte	WP06 data status	See section <i>Input process data status</i> [▶ page 109].
96	1 byte	Padding byte	Do not use
97 ... 112	16 byte	WP06 process input data	IO-Link input data of the IO-Link Device wireless connected to WP06. For a description of the data, see manual of the manufacturer of the used IO-Link Device.
113	1 byte	WP07 data status	See section <i>Input process data status</i> [▶ page 109].
114	1 byte	Padding byte	Do not use
115 ... 130	16 byte	WP07 process input data	IO-Link input data of the IO-Link Device wireless connected to WP07. For a description of the data, see manual of the manufacturer of the used IO-Link Device.
131	1 byte	WP08 data status	See section <i>Input process data status</i> [▶ page 109].
132	1 byte	Padding byte	Do not use

Byte	Number of bytes	Input process data	Description
133 ... 148	16 byte	WP08 process input data	IO-Link input data of the IO-Link Device wireless connected to WP08. For a description of the data, see manual of the manufacturer of the used IO-Link Device.
149	1 byte	WP09 data status	See section <i>Input process data status</i> [▶ page 109].
150	1 byte	Padding byte	Do not use
151 ... 166	16 byte	WP09 process input data	IO-Link input data of the IO-Link Device wireless connected to WP09. For a description of the data, see manual of the manufacturer of the used IO-Link Device.
167	1 byte	WP10 data status	See section <i>Input process data status</i> [▶ page 109].
168	1 byte	Padding byte	Do not use
169 ... 184	16 byte	WP10 process input data	IO-Link input data of the IO-Link Device wireless connected to WP10. For a description of the data, see manual of the manufacturer of the used IO-Link Device.
185	1 byte	WP11 data status	See section <i>Input process data status</i> [▶ page 109].
186	1 byte	Padding byte	Do not use
187 ... 202	16 byte	WP11 process input data	IO-Link input data of the IO-Link Device wireless connected to WP11. For a description of the data, see manual of the manufacturer of the used IO-Link Device.
203	1 byte	WP12 data status	See section <i>Input process data status</i> [▶ page 109].
204	1 byte	Padding byte	Do not use
205 ... 220	16 byte	WP12 process input data	IO-Link input data of the IO-Link Device wireless connected to WP12. For a description of the data, see manual of the manufacturer of the used IO-Link Device.
221	1 byte	WP13 data status	See section <i>Input process data status</i> [▶ page 109].
222	1 byte	Padding byte	Do not use
223 ... 238	16 byte	WP13 process input data	IO-Link input data of the IO-Link Device wireless connected to WP13. For a description of the data, see manual of the manufacturer of the used IO-Link Device.
239	1 byte	WP14 data status	See section <i>Input process data status</i> [▶ page 109].
240	1 byte	Padding byte	Do not use
241 ... 256	16 byte	WP14 process input data	IO-Link input data of the IO-Link Device wireless connected to WP14. For a description of the data, see manual of the manufacturer of the used IO-Link Device.
257	1 byte	WP15 data status	See section <i>Input process data status</i> [▶ page 109].
258	1 byte	Padding byte	Do not use
259 ... 274	16 byte	WP15 process input data	IO-Link input data of the IO-Link Device wireless connected to WP15. For a description of the data, see manual of the manufacturer of the used IO-Link Device.
275	1 byte	WP16 data status	See section <i>Input process data status</i> [▶ page 109].
276	1 byte	Padding byte	Do not use
277 ... 292	16 byte	WP16 process input data	IO-Link input data of the IO-Link Device wireless connected to WP16. For a description of the data, see manual of the manufacturer of the used IO-Link Device.

Table 58: Input process data, connection 5 to connection 7

### Output process data

The following table gives a description of the process data structure of the output process data and is valid for connection 5.

Byte	Number of bytes	Output process data	Description
1	1 byte	DO status	Reserved
2	1 byte	Padding byte	Do not use
3 ... 4	2 byte	DO data	Reserved
5	1 byte	WP01 Output enable	0: WP01 output data not valid. 1-255: WP01 output data valid.
6	1 byte	Padding byte	Do not use
7 ... 22	16 byte	WP01 process output data	IO-Link output data of the IO-Link Device wireless connected to WP01. For a description of the data, see manual of the manufacturer of the used IO-Link Device.
23	1 byte	WP02 Output enable	0: WP02 output data not valid. 1-255: WP02 output data valid.
24	1 byte	Padding byte	Do not use
25 ... 40	16 byte	WP02 process output data	IO-Link output data of the IO-Link Device wireless connected to WP02. For a description of the data, see manual of the manufacturer of the used IO-Link Device.
41	1 byte	WP03 Output enable	0: WP03 output data not valid. 1-255: WP03 output data valid.
41	1 byte	Padding byte	Do not use
43 ... 58	16 byte	WP03 process output data	IO-Link output data of the IO-Link Device wireless connected to WP03. For a description of the data, see manual of the manufacturer of the used IO-Link Device.
59	1 byte	WP04 Output enable	0: WP04 output data not valid. 1-255: WP04 output data valid.
60	1 byte	Padding byte	Do not use
61 ... 76	16 byte	WP04 process output data	IO-Link output data of the IO-Link Device wireless connected to WP04. For a description of the data, see manual of the manufacturer of the used IO-Link Device.
77	1 byte	WP05 Output enable	0: WP05 output data not valid. 1-255: WP05 output data valid.
78	1 byte	Padding byte	Do not use
79 ... 94	16 byte	WP05 process output data	IO-Link output data of the IO-Link Device wireless connected to WP05. For a description of the data, see manual of the manufacturer of the used IO-Link Device.
94	1 byte	WP06 Output enable	0: WP06 output data not valid. 1-255: WP06 output data valid.
96	1 byte	Padding byte	Do not use
97 ... 112	16 byte	WP06 process output data	IO-Link output data of the IO-Link Device wireless connected to WP06. For a description of the data, see manual of the manufacturer of the used IO-Link Device.
113	1 byte	WP07 Output enable	0: WP07 output data not valid. 1-255: WP07 output data valid.
114	1 byte	Padding byte	Do not use
115 ... 130	16 byte	WP07 process output data	IO-Link output data of the IO-Link Device wireless connected to WP07. For a description of the data, see manual of the manufacturer of the used IO-Link Device.
131	1 byte	WP08 Output enable	0: WP08 output data not valid. 1-255: WP08 output data valid.
132	1 byte	Padding byte	Do not use
133 ... 148	16 byte	WP08 process output data	IO-Link output data of the IO-Link Device wireless connected to WP08. For a description of the data, see manual of the manufacturer of the used IO-Link Device.



Byte	Number of bytes	Output process data	Description
149	1 byte	WP09 Output enable	0: WP09 output data not valid. 1-255: WP09 output data valid.
150	1 byte	Padding byte	Do not use
151 ... 166	16 byte	WP09 process output data	IO-Link output data of the IO-Link Device wireless connected to WP09. For a description of the data, see manual of the manufacturer of the used IO-Link Device.
167	1 byte	WP10 Output enable	0: WP10 output data not valid. 1-255: WP10 output data valid.
168	1 byte	Padding byte	Do not use
169 ... 184	16 byte	WP10 process output data	IO-Link output data of the IO-Link Device wireless connected to WP10. For a description of the data, see manual of the manufacturer of the used IO-Link Device.
185	1 byte	WP11 Output enable	0: WP11 output data not valid. 1-255: WP11 output data valid.
186	1 byte	Padding byte	Do not use
187 ... 202	16 byte	WP11 process output data	IO-Link output data of the IO-Link Device wireless connected to WP11. For a description of the data, see manual of the manufacturer of the used IO-Link Device.
203	1 byte	WP12 Output enable	0: WP12 output data not valid. 1-255: WP12 output data valid.
204	1 byte	Padding byte	Do not use
205 ... 220	16 byte	WP12 process output data	IO-Link output data of the IO-Link Device wireless connected to WP12. For a description of the data, see manual of the manufacturer of the used IO-Link Device.
221	1 byte	WP13 Output enable	0: WP13 output data not valid. 1-255: WP13 output data valid.
222	1 byte	Padding byte	Do not use
223 ... 238	16 byte	WP13 process output data	IO-Link output data of the IO-Link Device wireless connected to WP13. For a description of the data, see manual of the manufacturer of the used IO-Link Device.
239	1 byte	WP14 Output enable	0: WP14 output data not valid. 1-255: WP14 output data valid.
240	1 byte	Padding byte	Do not use
241 ... 256	16 byte	WP14 process output data	IO-Link output data of the IO-Link Device wireless connected to WP14. For a description of the data, see manual of the manufacturer of the used IO-Link Device.
257	1 byte	WP15 Output enable	0: WP15 output data not valid. 1-255: WP15 output data valid.
258	1 byte	Padding byte	Do not use
259 ... 274	16 byte	WP15 process output data	IO-Link output data of the IO-Link Device wireless connected to WP15. For a description of the data, see manual of the manufacturer of the used IO-Link Device.
275	1 byte	WP16 Output enable	0: WP16 output data not valid. 1-255: WP16 output data valid.
276	1 byte	Padding byte	Do not use
277 ... 292	16 byte	WP16 process output data	IO-Link output data of the IO-Link Device wireless connected to WP16. For a description of the data, see manual of the manufacturer of the used IO-Link Device.

Table 59: Output process data, connection 5



### 10.1.3 Connections 8 to 10

#### Input process data

The following table gives a description of the process data structure of the input process data and is valid for connection 8, connection 9 and connection 10.

Byte	Number of bytes	Input process data	Description
1	1 byte	DI status	Reserved
2	1 byte	Padding byte	Do not use
3 ... 4	2 byte	DI data	Reserved
5	1 byte	WP01 data status	See section <i>Input process data status</i> [▶ page 109].
6	1 byte	Padding byte	Do not use
7 ... 10	4 byte	WP01 process input data	IO-Link input data of the IO-Link Device wireless connected to WP01. For a description of the data, see manual of the manufacturer of the used IO-Link Device.
11	1 byte	WP02 data status	See section <i>Input process data status</i> [▶ page 109].
12	1 byte	Padding byte	Do not use
13 ... 16	4 byte	WP02 process input data	IO-Link input data of the IO-Link Device wireless connected to WP02. For a description of the data, see manual of the manufacturer of the used IO-Link Device.
17	1 byte	WP03 data status	See section <i>Input process data status</i> [▶ page 109].
18	1 byte	Padding byte	Do not use
19 ... 22	4 byte	WP03 process input data	IO-Link input data of the IO-Link Device wireless connected to WP03. For a description of the data, see manual of the manufacturer of the used IO-Link Device.
23	1 byte	WP04 data status	See section <i>Input process data status</i> [▶ page 109].
24	1 byte	Padding byte	Do not use
25 ... 28	4 byte	WP04 process input data	IO-Link input data of the IO-Link Device wireless connected to WP04. For a description of the data, see manual of the manufacturer of the used IO-Link Device.
29	1 byte	WP05 data status	See section <i>Input process data status</i> [▶ page 109].
30	1 byte	Padding byte	Do not use
31 ... 34	4 byte	WP05 process input data	IO-Link input data of the IO-Link Device wireless connected to WP05. For a description of the data, see manual of the manufacturer of the used IO-Link Device.
35	1 byte	WP06 data status	See section <i>Input process data status</i> [▶ page 109].
36	1 byte	Padding byte	Do not use
37... 40	4 byte	WP06 process input data	IO-Link input data of the IO-Link Device wireless connected to WP06. For a description of the data, see manual of the manufacturer of the used IO-Link Device.
38	1 byte	WP07 data status	See section <i>Input process data status</i> [▶ page 109].
39	1 byte	Padding byte	Do not use
40 ... 46	4 byte	WP07 process input data	IO-Link input data of the IO-Link Device wireless connected to WP07. For a description of the data, see manual of the manufacturer of the used IO-Link Device.
47	1 byte	WP08 data status	See section <i>Input process data status</i> [▶ page 109].
48	1 byte	Padding byte	Do not use

Byte	Number of bytes	Input process data	Description
49 ... 52	4 byte	WP08 process input data	IO-Link input data of the IO-Link Device wireless connected to WP08. For a description of the data, see manual of the manufacturer of the used IO-Link Device.
53	1 byte	WP09 data status	See section <i>Input process data status</i> [▶ page 109].
54	1 byte	Padding byte	Do not use
55 ... 58	4 byte	WP09 process input data	IO-Link input data of the IO-Link Device wireless connected to WP09. For a description of the data, see manual of the manufacturer of the used IO-Link Device.
59	1 byte	WP10 data status	See section <i>Input process data status</i> [▶ page 109].
60	1 byte	Padding byte	Do not use
61 ... 64	4 byte	WP10 process input data	IO-Link input data of the IO-Link Device wireless connected to WP10. For a description of the data, see manual of the manufacturer of the used IO-Link Device.
65	1 byte	WP11 data status	See section <i>Input process data status</i> [▶ page 109].
66	1 byte	Padding byte	Do not use
67 ... 70	4 byte	WP11 process input data	IO-Link input data of the IO-Link Device wireless connected to WP11. For a description of the data, see manual of the manufacturer of the used IO-Link Device.
71	1 byte	WP12 data status	See section <i>Input process data status</i> [▶ page 109].
72	1 byte	Padding byte	Do not use
73 ... 76	4 byte	WP12 process input data	IO-Link input data of the IO-Link Device wireless connected to WP12. For a description of the data, see manual of the manufacturer of the used IO-Link Device.
77	1 byte	WP13 data status	See section <i>Input process data status</i> [▶ page 109].
78	1 byte	Padding byte	Do not use
79 ... 82	4 byte	WP13 process input data	IO-Link input data of the IO-Link Device wireless connected to WP13. For a description of the data, see manual of the manufacturer of the used IO-Link Device.
83	1 byte	WP14 data status	See section <i>Input process data status</i> [▶ page 109].
84	1 byte	Padding byte	Do not use
85 ... 88	4 byte	WP14 process input data	IO-Link input data of the IO-Link Device wireless connected to WP14. For a description of the data, see manual of the manufacturer of the used IO-Link Device.
89	1 byte	WP15 data status	See section <i>Input process data status</i> [▶ page 109].
90	1 byte	Padding byte	Do not use
91 ... 94	4 byte	WP15 process input data	IO-Link input data of the IO-Link Device wireless connected to WP15. For a description of the data, see manual of the manufacturer of the used IO-Link Device.
95	1 byte	WP16 data status	See section <i>Input process data status</i> [▶ page 109].
96	1 byte	Padding byte	Do not use
97 ... 100	4 byte	WP16 process input data	IO-Link input data of the IO-Link Device wireless connected to WP16. For a description of the data, see manual of the manufacturer of the used IO-Link Device.

Table 60: Input process data, connection 8 to connection 10

## Output process data

The following table gives a description of the process data structure of the output process data and is valid for connection 8.

Byte	Number of bytes	Output process data	Description
1	1 byte	DO status	Reserved
2	1 byte	Padding byte	Do not use
3 ... 4	2 byte	DO data	Reserved
5	1 byte	WP01 Output enable	0: WP01 output data not valid. 1-255: WP01 output data valid.
6	1 byte	Padding byte	Do not use
7 ... 10	4 byte	WP01 process output data	IO-Link output data of the IO-Link Device wireless connected to WP01. For a description of the data, see manual of the manufacturer of the used IO-Link Device.
11	1 byte	WP02 Output enable	0: WP02 output data not valid. 1-255: WP02 output data valid.
12	1 byte	Padding byte	Do not use
13 ... 16	4 byte	WP02 process output data	IO-Link output data of the IO-Link Device wireless connected to WP02. For a description of the data, see manual of the manufacturer of the used IO-Link Device.
17	1 byte	WP03 Output enable	0: WP03 output data not valid. 1-255: WP03 output data valid.
18	1 byte	Padding byte	Do not use
19 ... 22	4 byte	WP03 process output data	IO-Link output data of the IO-Link Device wireless connected to WP03. For a description of the data, see manual of the manufacturer of the used IO-Link Device.
23	1 byte	WP04 Output enable	0: WP04 output data not valid. 1-255: WP04 output data valid.
24	1 byte	Padding byte	Do not use
25 ... 28	4 byte	WP04 process output data	IO-Link output data of the IO-Link Device wireless connected to WP04. For a description of the data, see manual of the manufacturer of the used IO-Link Device.
29	1 byte	WP05 Output enable	0: WP05 output data not valid. 1-255: WP05 output data valid.
30	1 byte	Padding byte	Do not use
31 ... 34	4 byte	WP05 process output data	IO-Link output data of the IO-Link Device wireless connected to WP05. For a description of the data, see manual of the manufacturer of the used IO-Link Device.
35	1 byte	WP06 Output enable	0: WP06 output data not valid. 1-255: WP06 output data valid.
36	1 byte	Padding byte	Do not use
37... 40	4 byte	WP06 process output data	IO-Link output data of the IO-Link Device wireless connected to WP06. For a description of the data, see manual of the manufacturer of the used IO-Link Device.
38	1 byte	WP07 Output enable	0: WP07 output data not valid. 1-255: WP07 output data valid.
39	1 byte	Padding byte	Do not use
40 ... 46	4 byte	WP07 process output data	IO-Link output data of the IO-Link Device wireless connected to WP07. For a description of the data, see manual of the manufacturer of the used IO-Link Device.
47	1 byte	WP08 Output enable	0: WP08 output data not valid. 1-255: WP08 output data valid.
48	1 byte	Padding byte	Do not use
49 ... 52	4 byte	WP08 process output data	IO-Link output data of the IO-Link Device wireless connected to WP08. For a description of the data, see manual of the manufacturer of the used IO-Link Device.

Byte	Number of bytes	Output process data	Description
53	1 byte	WP09 Output enable	0: WP09 output data not valid. 1-255: WP09 output data valid.
54	1 byte	Padding byte	Do not use
55 ... 58	4 byte	WP09 process output data	IO-Link output data of the IO-Link Device wireless connected to WP09. For a description of the data, see manual of the manufacturer of the used IO-Link Device.
59	1 byte	WP10 Output enable	0: WP10 output data not valid. 1-255: WP10 output data valid.
60	1 byte	Padding byte	Do not use
61 ... 64	4 byte	WP10 process output data	IO-Link output data of the IO-Link Device wireless connected to WP10. For a description of the data, see manual of the manufacturer of the used IO-Link Device.
65	1 byte	WP11 Output enable	0: WP11 output data not valid. 1-255: WP11 output data valid.
66	1 byte	Padding byte	Do not use
67 ... 70	4 byte	WP11 process output data	IO-Link output data of the IO-Link Device wireless connected to WP11. For a description of the data, see manual of the manufacturer of the used IO-Link Device.
71	1 byte	WP12 Output enable	0: WP12 output data not valid. 1-255: WP12 output data valid.
72	1 byte	Padding byte	Do not use
73 ... 76	4 byte	WP12 process output data	IO-Link output data of the IO-Link Device wireless connected to WP12. For a description of the data, see manual of the manufacturer of the used IO-Link Device.
77	1 byte	WP13 Output enable	0: WP13 output data not valid. 1-255: WP13 output data valid.
78	1 byte	Padding byte	Do not use
79 ... 82	4 byte	WP13 process output data	IO-Link output data of the IO-Link Device wireless connected to WP13. For a description of the data, see manual of the manufacturer of the used IO-Link Device.
83	1 byte	WP14 Output enable	0: WP14 output data not valid. 1-255: WP14 output data valid.
84	1 byte	Padding byte	Do not use
85 ... 88	4 byte	WP14 process output data	IO-Link output data of the IO-Link Device wireless connected to WP14. For a description of the data, see manual of the manufacturer of the used IO-Link Device.
89	1 byte	WP15 Output enable	0: WP15 output data not valid. 1-255: WP15 output data valid.
90	1 byte	Padding byte	Do not use
91 ... 94	4 byte	WP15 process output data	IO-Link output data of the IO-Link Device wireless connected to WP15. For a description of the data, see manual of the manufacturer of the used IO-Link Device.
95	1 byte	WP16 Output enable	0: WP16 output data not valid. 1-255: WP16 output data valid.
96	1 byte	Padding byte	Do not use
97 ... 100	4 byte	WP16 process output data	IO-Link output data of the IO-Link Device wireless connected to WP16. For a description of the data, see manual of the manufacturer of the used IO-Link Device.

Table 61: Output process data, connection 8

## 10.1.4 Input process data status

Bit	Description
0 ... 2	Reserved
3	IO-Link event available This bit has the same value as attribute 20 of the instance of the Event Log Object 65 (0x41). 0: No IO-Link event is available. 1: IO-Link event is available in the instance for the port of the Event Log Object.
4	Reserved
5	Device communication (DevCom) 0: The connected device is not in PreOperate or Operate state. 1: The connected device is in PreOperate or Operate state.
6	Device error (DevErr) 0: No error, no warning. 1: Error or a warning occurred assigned to either device or port.
7	Port qualifier (PQ) 0: Input process data is not valid. 1: Input process data is valid.

Table 62: Input data status

## 10.2 OPC UA

The device contains an OPC UA server. An OPC UA client can establish a connection to the device and access the following parameters:

- device identification,
- identification of the IO-Link Devices
- etc.

The OPC UA client establishes a connection via the following URL:

```
opc.tcp://IP address:4840
```

For IP address, use the IP address of the device.

The client can access device parameters anonymously (read only) or with user name/password (read and write). The user name and password are set with the netFIELD Wireless Web Server.

The following figure shows a section of the information model of the device.

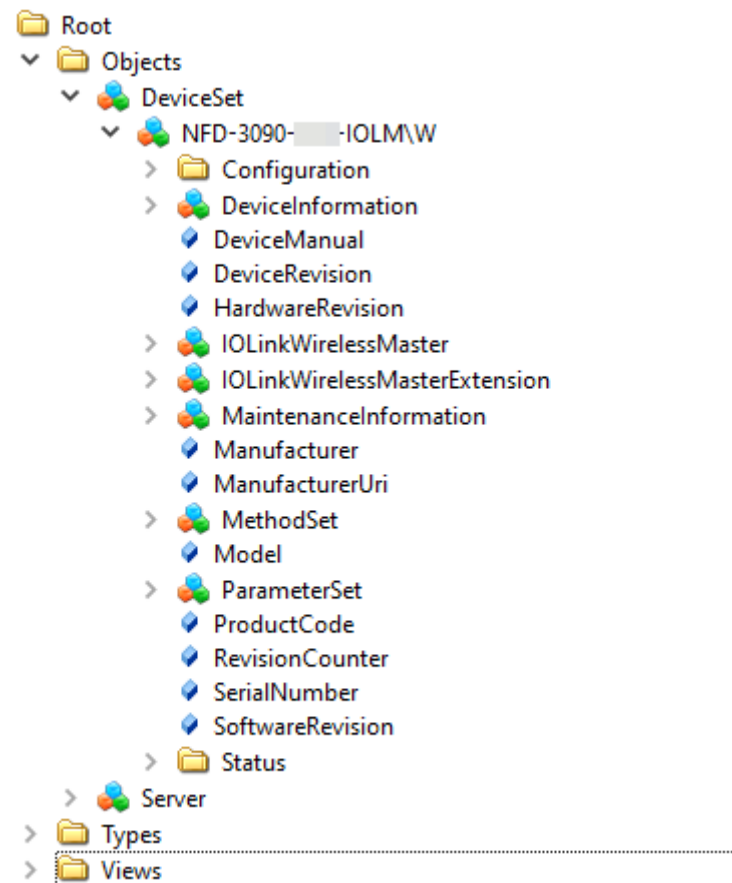

Figure 52: OPC UA: Information model of the device

## 10.2.1 Device identification

The device provides nodes for device identification. For example, the OPC UA client can read the version of the device firmware used in the `SoftwareRevision` node. The path to these nodes is

```
Root > Object > DeviceSet > [Device name]
```

Node name	Node class	Access	Description
Manufacturer	Variable	read	Device manufacturer
ManufacturerUri	Variable	read	URL of the device manufacturer
Model	Variable	read	Model name of the device
ProductCode	Variable	read	Product code of the device
RevisionCounter	Variable	read	Hardware revision of the device
SerialNumber	Variable	read	Serial number of the device
SoftwareRevision	Variable	read	Revision/version of the device firmware

*Table 63: Device identification*

## 10.2.2 Identification of connected IO-Link Devices

The device provides nodes for the identification of connected IO-Link Devices. For example, the OPC UA client can read the version of the device firmware used in the `SoftwareRevision` node. The path to these nodes is

```
Root > Object > DeviceSet > [Device name] >
IOLinkWirelessMaster > PortXX > Device
```

Node name	Node class	Access	Description
Manufacturer	Variable	read	Device manufacturer
MinCycleTime	Variable	read	Minimal cycle time
Model	Variable	read	Model name
RevisionID	Variable	read	Hardware revision
SerialNumber	Variable	read	Serial number
SoftwareRevision	Variable	read	Revision/version of the firmware
VendorID	Variable	read	Vendor identification

*Table 64: Identification of the connected IO-Link Devices*

### 10.2.3 NTP Client configuration

The OPC UA server provides nodes for configuring the NTP client.

Path to these nodes:

```
Root > Object > DeviceSet > [Device Name] >
Configuration > NtpClient > Configuration >
CurrentConfiguration
```

Node name	Node class	Access	Default	Description
NtpClientServerIpAddress	Variable	read / write	0	IP address of the NTP server The NTP client uses the set IP address to get the date and time from an NTP server. The IP address must be converted into a decimal number. The calculation is explained below the table. The value 0 disables the function.
NtpClientServerIpAddressFallback	Variable	read / write	0	IP address of the NTP server (fallback) Optional additional IP address if the NTP server cannot be reached via the IP address in the NtpClientServerIpAddress node. The IP address must be converted into a decimal number. The calculation is explained below the table. The value 0 disables the function.
NtpClientUpdateConfiguration	Method	write	-	Method for writing the nodes NtpClientServerIpAddress and NtpClientServerIpAddressFallback.

Table 65: NTP client configuration

#### Explanation of the calculation

To convert the IP address to a decimal number, use the following formula.  
Starting from an IP address in the format A.B.C.D:

$$((A * 256 + B) * 256 + C) * 256 + D = \text{IP address as a decimal number}$$

Example of IP address 192.53.103.108

$$((192 * 256 + 53) * 256 + 103) * 256 + 108 = 3224725356$$



## 10.3 MQTT topics

### 10.3.1 General parts of a topic

The description of a topic contains parts that will be substituted.

Topic part	Description
{prefix}	Prefix of each topic. The prefix is a text used to identify a device. Configurable in the netFIELD Wireless Web Server.
[MASTER_NUMBER]	Number for each master in the gateway. Typically, the gateway has one master and MASTER_NUMBER is 1.
[PORT_NUMBER]	Number for each port of a master. If the master has 8 ports for example, PORT_NUMBER is 1 ... 8.
[DEVICE_ALIAS]	String to identify a device connected to a port of a master: masterXportY. Example: master1port3.

Table 66: General parts of a topic

### 10.3.2 Gateway topics

Topic	Description
{prefix}/iolink/v1/gateway/identification	Identification of the gateway: MAC address, serial number, product ID, vendor name, product name, hardware revision, firmware revision For an example, see Gateway identification.
{prefix}/iolink/v1/gateway/capabilities	Capabilities of the gateway: IODD supported, MQTT supported For an example, see Gateway capabilities.
{prefix}/iolink/v1/gateway/configuration	Network configuration of the gateway: IP configuration, IP address, subnet mask, standard gateway For an example, see Gateway configuration.

Table 67: Gateway topics

You will find examples of and details about the transferred JSON objects below.

#### Gateway identification

Example of the gateway identification JSON object:

```
{
  "macAddress": "01:02:03:04:05:06",
  "serialNumber": "12345678",
  "productID": "TMP34Z",
  "vendorName": "SensorCompany",
  "productName": "FlowSensor34",
  "hardwareRevision": "V2.34",
  "firmwareRevision": "V1.23"
}
```

#### Gateway capabilities

JSON key	Description
ioddSupported	"ioddSupported": true: IODD is available "ioddSupported": false: IODD is not available
mqttSupported	"mqttSupported": true: MQTT is available "mqttSupported": false: MQTT is not available

Table 68: Gateway capabilities, "JSON key"

Example of the gateway capabilities JSON object:

```
{
  "ioddSupported": true,
  "mqttSupported": false
}
```

### Gateway configuration

JSON key	Description
"ipConfiguration"	Possible values for "ipConfiguration": <ul style="list-style-type: none"> <li>• "MANUAL": Assignment of the IP address by other device-specific means.</li> <li>• "DHCP": RFC 2131 defines the "Dynamic Host Configuration Protocol" that allows automatic assignment of IP addresses.</li> <li>• "DCP": PROFINET defines the "Discovery and Configuration Protocol", a link-layer protocol that allows the manual assignment of IP addresses.</li> </ul>

Table 69: Gateway configuration, "JSON key"

Example of the gateway configuration JSON object:

```
{
  "ethIpv4":
  [
    {
      "ipConfiguration": "MANUAL",
      "ipAddress": "192.168.1.13",
      "subnetMask": "255.255.255.0",
      "standardGateway": "192.168.1.1"
    }
  ]
}
```

### 10.3.3 Master topics

Topic	Description
{prefix}/iolink/v1/masters	Available master number keys and identification information: Master number, serial number, location tag For an example, see Master list.
{prefix}/iolink/v1/masters/[MASTER_NUMBER]/capabilities	Capabilities of the master: Number of ports, max. power supply (of the device) Example: {prefix}/iolink/v1/masters/1/capabilities For an example, see Master capabilities.
{prefix}/iolink/v1/masters/[MASTER_NUMBER]/identification	Identification of the master: Vendor name, vendor ID, master ID, master type, serial number, application-specific tag, location tag, function tag Example: {prefix}/iolink/v1/masters/1/identification For an example, see Master identification.
{prefix}/iolink/v1/masters/[MASTER_NUMBER]/ports	Available port number keys: Port number, status info, device alias Example: {prefix}/iolink/v1/masters/1/ports For an example, see Port list.
{prefix}/iolink/v1/masters/[MASTER_NUMBER]/ports/[PORT_NUMBER]/capabilities	Capability information of the port: Max power supply (of the port), port type Example: {prefix}/iolink/v1/masters/1/ports/4/capabilities For an example, see Port capabilities.
{prefix}/iolink/v1/masters/[MASTER_NUMBER]/ports/[PORT_NUMBER]/status	Current status of the port: Status Info, IO-Link revision, master cycle time Example: {prefix}/iolink/v1/masters/1/ports/4/status For an example, see Port status.
{prefix}/iolink/v1/masters/[MASTER_NUMBER]/ports/[PORT_NUMBER]/configuration	Configuration of the port: Mode, validation and backup, cycle time, vendor ID, device ID, slot number, track number, device TX power, max retry, IMA time (I-am-alive time), slot type, low power device, max PD segment length, unique ID, device alias Example: {prefix}/iolink/v1/masters/1/ports/4/configuration For an example, see Port configuration.
{prefix}/iolink/v1/masters/[MASTER_NUMBER]/ports/[PORT_NUMBER]/datastorage	Data storage content of the port: Vendor ID, device ID, IO-Link revision Example: {prefix}/iolink/v1/masters/1/ports/4/datastorage For an example, see Port data storage.

Table 70: Master topics

You will find examples of and details about the transferred JSON objects below.

## Master list

Example of the master list JSON object:

```
[
  {
    "masterNumber": 1,
    "serialNumber": "A0A1A2A3A4",
    "locationTag": "slot 2"
  },
  {
    "masterNumber": 2,
    "serialNumber": "B0B1B2B3B4",
    "locationTag": "slot 3"
  }
]
```

## Master capabilities

Example of the master capabilities JSON object:

```
{
  "numberOfPorts": 8,
  "maxPowerSupply": {
    "value": 0.3,
    "unit": "A"
  }
}
```

## Master Identification

Example of the master identification JSON object:

```
{
  "vendorName": "Vendor GmbH",
  "vendorId": 26,
  "masterId": 42,
  "masterType": "Master acc. V1.0",
  "serialNumber": "IOLM123456",
  "applicationSpecificTag": "Fallback reader",
  "locationTag": "Down under",
  "functionTag": "Code reading"
}
```

**Port list**

JSON key	Description
statusInfo	Activated: "statusInfo": "DEVICE_ONLINE" Deactivated: "statusInfo": "DEACTIVATED"
deviceAlias	Default values for "deviceAlias": "masterXportY"

Table 71: Port list, "JSON key"

Example of the port list JSON object:

```
[
  {
    "portNumber": 1,
    "statusInfo": "DEVICE_ONLINE",
    "deviceAlias": "master1port1"
  },
  {
    "portNumber": 2,
    "statusInfo": "DEVICE_ONLINE",
    "deviceAlias": "master1port2"
  },
  {
    "portNumber": 3,
    "statusInfo": "DEVICE_ONLINE",
    "deviceAlias": "master1port3"
  },
  {
    "portNumber": 4,
    "statusInfo": "DEACTIVATED",
    "deviceAlias": "master1port4"
  }
]
```

**Port capabilities**

JSON key	Description
portType	Value for "portType" for IO-Link Wireless Master: "WIRELESS_MASTER"

Table 72: Port capabilities, "JSON key"

Example of the port capabilities JSON object:

```
{
  "maxPowerSupply": {
    "value": 0.3,
    "unit": "A"
  },
  "portType": "WIRELESS_MASTER"
}
```

### Port status

JSON key	Description
statusInfo	Activated: "statusInfo": "DEVICE_ONLINE" Deactivated: "statusInfo": "Deactivated"

Table 73: Port status, "JSON key"

Example of the IO-Link wireless port status JSON object:

```
{
  "statusInfo": "DEVICE_ONLINE",
  "iolinkRevision" : "1.1",
  "masterCycleTime" : {
    "value" : "5.0",
    "unit" : "ms"
  }
}
```

### Port configuration

JSON key	Values
mode	<ul style="list-style-type: none"> <li>"DEACTIVATED"</li> <li>"IOLINK_CYCLIC"</li> <li>"IOLINK_ROAMING"</li> </ul>
validationAndBackup	<ul style="list-style-type: none"> <li>"NO_DEVICE_CHECK"</li> <li>"TYPE_COMPATIBLE"</li> <li>"TYPE_COMPATIBLE_RESTORE_ONLY"</li> <li>"TYPE_COMPATIBLE_BACKUP_AND_RESTORE"</li> </ul>
slotNumber	0 ... 7
trackNumber	0 ... 2
deviceTxPower	1 ... 31
maxRetry	2 ... 31
imaTime	<ul style="list-style-type: none"> <li>"SINGLE_SLOT"</li> <li>"DOUBLE_SLOT"</li> </ul>
maxPdSegmentLength	1 ... 32

Table 74: Port configuration, "JSON key"

Example of the IO-Link wireless configuration JSON object:

```
{
  "mode": "IOLINK_MANUAL",
  "validationAndBackup" : "TYPE_COMPATIBLE",
  "cycleTime" : {
    "value" : "5.0",
    "unit" : "ms"
  },
  "vendorId" : 26,
  "deviceId" : 333,
  "slotNumber" : 0,
  "trackNumber" : 1,
  "deviceTxPower" : 31,
  "maxRetry" : 2,
  "imaTime" : 771,
  "slotType" : "SINGLE_SLOT",
  "lowPowerDevice" : false,
  "maxPdSegmentLength" : 2,
  "uniqueId" : [11, 12, 13, 14, 15, 16, 17, 18],
  "deviceAlias" : "Distance_sensor_1"
}
```

Example of the cycle time object JSON object:

```
{
  "value" : "5.0",
  "unit" : "ms"
}
```

### Port data storage

Example of the port data storage JSON object:

```
{
  "header": {
    "vendorId": 15,
    "deviceId": 65253,
    "iolinkRevision": "1.1"
  },
  "content": "YmFzZTY0IGVuY3J5cHRlZCBjb250ZW50"
}
```

### 10.3.4 Device topics

Topic	Description
{prefix}/iolink/v1/devices	Address all devices of all masters: Device alias, master number, port number For an example, see Device list.
{prefix}/iolink/v1/devices/[DEVICE_ALIAS]/processdata/value	Process data value of the device: Get data (IO-Link, IQ value), set data (IO-Link, IQ value) Example: {prefix}/iolink/v1/devices/master1port4/processdata/value For an example, see Device process data.
{prefix}/iolink/v1/devices/[DEVICE_ALIAS]/processdata/getdata/value	Process data input value of the device: Get Data (IO-Link, IQ value) Example: {prefix}/iolink/v1/devices/master1port4/processdata/getdata/value For an example, see Device process data input.
{prefix}/iolink/v1/devices/[DEVICE_ALIAS]/processdata/setdata/value	Process data output value of the device: Set Data (IO-Link, IQ value) Example: {prefix}/iolink/v1/devices/master1port4/processdata/setdata/value For an example, see Device process data output.
iolink/v1/devices/[DEVICE_ALIAS]/events	Event log of the device: Time, severity, origin, message Example: {prefix}/iolink/v1/devices/master1port4/events For an example, see Device events.

Table 75: Device topics

#### Device list (JSON object)

Example of the device list JSON object:

JSON key	Description
deviceAlias	Device alias
masterNumber	Master number
portNumber	Port number

Table 76: Device list (JSON object)

Example of the device list JSON object:

```
[
  {
    "deviceAlias" : "DT35",
    "masterNumber" : 1,
    "portNumber" : 1,
  },
  {
    "deviceAlias" : "DT36",
    "masterNumber" : 1,
    "portNumber" : 2,
  },
  {
    "deviceAlias" : "DT37",
    "masterNumber" : 1,
    "portNumber" : 3,
  },
  {
    "deviceAlias" : "DT38",
    "masterNumber" : 1,
    "portNumber" : 4,
  },
]
```



**Device identification (JSON object)**

JSON key	Description
vendorId	Vendor identification, number
deviceId	Device identification, number
iolinkRevision	Supported IO-Link version
vendorName	Vendor name, text
productId	Product identification
productText	Text about the product
hardwareRevision	Hardware revision
firmwareRevision	Firmware revision
applicationSpecificTag	Applications specific text

*Table 77: Device identification (JSON object)*

Example of the device identification JSON object:

```
{
  "vendorId": 12345,
  "deviceId": 5,
  "iolinkRevision": "1.1",
  "vendorName": "Vendor Name",
  "vendorText": "www.url.com",
  "productName": "A123",
  "productId": "A123",
  "productText": "Sensor",
  "hardwareRevision": "2",
  "firmwareRevision": "123",
  "applicationSpecificTag": "abcd"
}
```

### Device process data (JSON object)

Example of the device process data JSON object:

JSON key	Description
getData	Get Data
iolink	IO-Link
iqValue	IQ value
setData	Set Data
iolink	IO-Link
iqValue	IQ value

Table 78: Device process data (JSON object)

Example of the device process data JSON object

For an IO-Link device:

```
{
  "getData" : {
    "iolink" : {
      "valid" : true,
      "value" : [12,22,216]
    },
    "iqValue" : false
  },
  "setData" : {
    "iolink" : {
      "valid" : true,
      "value" : [128,221,134]
    },
    "iqValue" : false
  }
}
```

### Device process data input (JSON object)

Example of the device process data input JSON object:

JSON key	Description
getData	Get Data
iolink	IO-Link
iqValue	IQ value

Table 79: Device process data input (JSON object)

Example of the device process data input JSON object

For an IO-Link device:

```
{
  "getData" : {
    "iolink" : {
      "valid" : true,
      "value" : [12,22,216]
    },
    "iqValue" : false
  }
}
```

### Device process data output (JSON object)

Example of the device process data output JSON object:

JSON key	Description
setData	Set Data
iolink	IO-Link
iqValue	IQ value

Table 80: Device process data output (JSON object)

Example of the device process data output JSON object

For an IO-Link device:

```
{
  "getData" : {},
  "setData" : {
    "iolink" : {
      "valid" : true,
      "value" : [128,221,134]
    },
    "iqValue" : false
  }
}
```

### Device events (JSON object)

Example of the device events JSON object:

JSON key	Description
time	Time
severity	Severity
origin	Origin
message	Message

Table 81: Device events (JSON object)

Example of the device events JSON object

```
[
  {
    "time" : "2018-05-18T07:31:54.123z",
    "severity" : "WARNING",
    "origin" : {
      "master" : 1,
      "port" : 1,
      "device" : "Temp sensor 1",
    },
    "message" : {
      "code" : 16912,
      "mode" : "APPEARS",
      "text" : "Device temperature over-run - Clear source of
heat"
    }
  }
]
```

### 10.3.5 MQTT topics

Topic	Description
{prefix}/iolink/v1/mqtt/configuration	Configuration of MQTT client: Client mode, server address, user name, password, last will, keep alive time For an example, see MQTT configuration.
{prefix}/iolink/v1/mqtt/connectionstatus	Configuration of MQTT client: Connection status, server address, up time For an example, see MQTT connection status.

Table 82: MQTT topics

You will find examples of and details about the transferred JSON objects below.

#### MQTT configuration

JSON key	Description
clientMode	Activated: "clientMode": "ACTIVE" Deactivated: "clientMode": "INACTIVE"

Table 83: MQTT configuration, "JSON key"

Example of the MQTT configuration JSON object:

```
{
  "clientMode" : "ACTIVE",
  "serverAddress" : "192.168.2.1./mqttserver",
  "username" : "iolink_json",
  "password" : "123456",
  "lastWill" : {
    "topic" : "my temperature sensor",
    "message" : "Process data transfer stopped",
    "qoS" : "0_ONLY_ONCE",
    "retain" : true
  },
  "keepAliveTime" : 0
}
```

#### MQTT connection status

JSON key	Description
connectionStatus	Possible values for "connectionStatus": <ul style="list-style-type: none"> <li>• CONNECTING</li> <li>• CONNECTION_ACCEPTED</li> <li>• CLIENT_INACTIVE</li> </ul>

Table 84: MQTT connection status, "JSON key"

Example of the MQTT connection status JSON object:

```
{
  "connectionStatus" : "CONNECTION_ACCEPTED",
  "serverAddress" : "192.168.2.1./mqttserver",
  "upTime" : 123
}
```

# 11 Diagnosis

## 11.1 Diagnosis via LEDs

### 11.1.1 System LED

The system status LED **SYS** can assume the states described below.











LED	Color	State	Description
SYS	Duo-LED: yellow RDY / green RUN		
	 (green)	On	The firmware is running.
	 (green)	Blinking	During the formatting of the file system
	 (yellow)	On	A system error has occurred.
	 (yellow) /  (green)	Blinking, 3x yellow, 3x green	Firmware crash, unrecoverable (an internal exception occurred that cannot be handled)
	 (yellow) /  (green)	Blinking, 1 Hz	Firmware update mode active: The firmware is idle and waiting for the update file.
	 (yellow) /  (green)	Blinking, 4 Hz	Firmware update mode active: A firmware update is being installed.
 (gray)	Off	<ul style="list-style-type: none"> <li>No supply voltage: No supply voltage for the device or hardware defect.</li> <li>During a firmware reset</li> </ul>	

Table 85: States of the SYS-LED

LED state	Definition
Blinking	The LED turns on and off in phases.
Blinking, 3x yellow, 3x green	The LED turns on and off, with a frequency of approx. 1 Hz: <ul style="list-style-type: none"> <li>3x yellow "On" for 500 ms and "Off" for 500 ms and</li> <li>3x green "On" for 500 ms and "Off" for 500 ms.</li> </ul>
Blinking, yellow/green, 1 Hz, 4 Hz	The LED turns on in phases yellow or green, with a frequency of approx.: <ul style="list-style-type: none"> <li>1 Hz: 1 x yellow "On" for 500 ms and 1 x green "On" for 500 ms,</li> <li>4 Hz: 1 x yellow "On" for 125 ms and 1 x green "On" for 125 ms.</li> </ul>

Table 86: Definitions of the states of the SYS LED

## 11.1.2 APL LED

The application LED **APL** indicates the internal communication status as described below.





LED	Color	State	Description
APL	<b>Duo LED red/green/yellow</b> (yellow = red and green simultaneously)		
	 (green)	On	The IO-Link Wireless Master firmware is running.
	 (green)	Blinking, 4 Hz	Firmware update mode IO-Link Wireless Master components active: A firmware update is being installed.
	 (yellow)	On	IO-Link Wireless Master system error during initialization
	 (red)	On	IO-Link Wireless Master critical error
	 (gray)	Off	IO-Link Wireless Master off or not initialized

Table 87: APL LED states

## 11.1.3 Supply voltage status

The supply voltage status LEDs **1L** and **2L** indicate the states described below.





LED	Color	State	Description
1L	<b>Duo LED red/green</b>		
	 (green)	On	1L supply voltage ok
	 (gray)	Off	No 1L supply voltage
2L	<b>Duo LED red/green</b>		
	 (green)	On	2L supply voltage ok
	 (gray)	Off	No 2L supply voltage

Table 88: Supply voltage status 1L and 2L

### 11.1.4 EtherNet/IP Adapter status

The **MS** and **NS** LEDs indicate the status of the EtherNet/IP Adapter. The LINK and ACT LEDs indicate the status of the Ethernet.

#### Communication status EtherNet/IP Adapter

The following table describes the LED states of the EtherNet/IP Adapter communication status.















LED	Color	State	Description
<b>MS</b> (module status) Position in the device overview: (7)	<b>Duo LED red/green</b>		
	 (green)	On	<b>Device operational:</b> The device is operating correctly.
	 (green)	Flashing (1 Hz)	<b>Standby:</b> The device has not been configured.
	 (green/red/green)	Flashing fast green/red/green	<b>Self-test:</b> The device performs a self-test after power-on. The following sequence is displayed during the self-test: <ul style="list-style-type: none"> <li>• NS LED off.</li> <li>• MS LED turns green for approximately 250 ms, turns red for approximately 250 ms, and again turns green (and holds that state until the power-up test has completed).</li> <li>• NS LED turns green for approximately 250 ms, turns red for approximately 250 ms, and then turns off (and holds that state until the power-up test has completed).</li> </ul>
	 (red/green/off)	Flashing sequence red/green/off	<b>Flashing sequence:</b> The flashing sequence is used to visually identify the device. The scanner can start the flashing sequence in Identity object 1 of the device. The MS LED and NS LED perform the flashing sequence simultaneously.
	 (red)	Flashing (1 Hz)	<b>Major recoverable fault:</b> The device has detected a major recoverable fault. E.g., an incorrect or inconsistent configuration can be considered a major recoverable fault.
	 (red)	On	<b>Major unrecoverable fault:</b> The device has detected a major unrecoverable fault.
	 (off)	Off	<b>No power:</b> The device is powered off.
<b>NS</b> (Network status) Position in the device overview: (8)	<b>Duo LED red/green</b>		
	 (green)	On	<b>Connected:</b> An IP address is configured, at least one CIP connection (any transport class) is established, and an Exclusive Owner connection has not timed out.
	 (green)	Flashing (1 Hz)	<b>No connections:</b> An IP address is configured, but no CIP connections are established, and an Exclusive Owner connection has not timed out.
	 (green/red/green)	Flashing fast green/red/green	<b>Self-test:</b> The device performs a self-test after power-on. Refer to the description of the MS LED in the self-test status.
	 (red/green/off)	Flashing sequence red/green/off	<b>Flashing sequence:</b> The flashing sequence is used to visually identify the device. The scanner can start the flashing sequence in Identity object 1 of the device. The MS LED and NS LED perform the flashing sequence simultaneously.
	 (red)	Flashing (1 Hz)	<b>Connection timeout:</b> An IP address is configured, and an Exclusive Owner connection for which this device is the target has timed out.  The NS LED returns to steady green only when all timed out Exclusive Owner connections are reestablished.
	 (red)	On	<b>Duplicate IP:</b> The device has detected that its IP address is already in use.
	 (off)	(Off)	<b>Not powered, no IP address:</b> The device does not have an IP address (or is powered off).

Table 89: Communication status EtherNet/IP Adapter

LED state	Definition
Flashing (1 Hz)	The LED turns on and off with a frequency of 1 Hz: "on" for 500 ms, followed by "off" for 500 ms.
Flashing fast green/red/green	The MS LED or NS LED turns on green "On" for 250 ms, then red "On" for 250 ms, then green "On" (until the test is completed).
Flashing sequence red/green/off	The MS LED and NS LED each turn red "On" for 500 ms, then green "On" for 500 ms, then "Off" for 500 ms. This flashing sequence is repeated at least 6 times.

Table 90: Definition LED states communication status

### Ethernet status EtherNet/IP Adapter

The following table describes the LED states of the EtherNet/IP Adapter Ethernet status.

LED	Color	State	Description
<b>LINK</b> Ch0: (30) , Ch1: (29)	<b>LED green</b>		
	● (green)	On	The device is linked to the Ethernet.
	● (off)	Off	The device has no link to the Ethernet.
<b>ACT</b> Ch0: (31) , Ch1: (28)	<b>LED yellow</b>		
	● (yellow)	Flickering (load dependent)	The device sends/receives Ethernet frames.
	● (off)	Off	The device does not send/receive Ethernet frames.

Table 91: Ethernet status EtherNet/IP Adapter

LED state	Definition
Flickering (load dependent)	The LED turns on and off with a frequency of approximately 10 Hz to indicate high Ethernet activity: "On" for approximately 50 ms, followed by "Off" for 50 ms. The LED turns on and off in irregular intervals to indicate low Ethernet activity.

Table 92: Definition LED states Ethernet status



### 11.1.5 Wireless track status

The wireless track status LEDs **WT1 ... WT3** indicate the states for the wireless tracks 1, 2, and 3, as described below.





LED	Color	State	Description
<b>WT1 ... WT3</b>	Duo LED red/green/yellow (yellow = red and green simultaneously)		
	 (green)	On	Track operational mode and track service mode
	 (yellow)	On	Track inactive
	 (red)	Blinking	Track error
	 (gray)	Off	Track off

Table 93: Wireless track status WT1 ... WT3

### 11.1.6 Wireless port status

The wireless port status LEDs **WP01 ... WP16** indicate the states for the wireless ports 1 ... 16 as described below.







LED	Color	State	Description
<b>WP01 ... WP16</b>	Duo LED red/green/yellow (yellow = red and green simultaneously)		
	 (green)	On	Port operational (OPERATE)
	 (green)	Blinking	Port communication ready (PREOPERATE)
	 (yellow)	Blinking	Port not available (NOT AVAILABLE, DEACTIVATED)
	 (red)	Blinking	Port communication lost, pairing timeout (NO DEVICE)
	 (red)	On	Port errors: Revision, compatibility, serial number, process data, cycle time, connection mode, wrong slot and page1 read failures (PORT_DIAG, PAIRING_FAULT)
	 (gray)	Off	Port inactive (INACTIVE)

Table 94: Wireless port status WP01 ... WP16

## 11.2 Diagnosis via EtherNet/IP

The IO-Link Wireless Master device NFD-3090-EIS-IOLMW contains the Event Log object with information about IO-Link events. The PLC can read attributes of the Event Log object, in order to get the „Event Qualifier“ and „Event Code“ of an IO-Link Event. Each IO-Link port has an assigned CIP instance.

Section *Event Log Object 65 (0x41)* [▶ page 130] describes the attributes of the object.

### 11.2.1 Event Log Object 65 (0x41)

The Event Log Object contains information on IO-Link events.

#### Instance 0 (class attributes)

Attribute	Name	NV	Access	Data type	Description	Default
1 (0x01)	Revision	NV	Get	UINT	Revision of this object	1
2 (0x02)	Max. instance	NV	Get	UINT	Number of IO-Link ports	Number of available IO-Link ports
32 (0x20)	Time Format	NV	Get	USINT	Data type identifier of the time format Only THE STIME data type is supported.	204 (0xCC) = STIME
33 (0x21)	Present Time	NV	Get	STIME	Default for time value Applies to all instances.	0

Table 95: Class attributes event log object 65 (0x41)

#### Instances 100, 101, ... (instance attributes)

The following table shows the mapping of CIP instances to the IO-Link ports.

IO-Link port	CIP instance
1	100
2	101
3	102
...	...

Table 96: Mapping CIP instances to IO-Link ports

The following table describes the attributes of the instances 100, 101, ...

Attribute	Name	NV	Access	Data type	Description	Default
2 (0x02)	State	V	Get	USINT	State of this instance 0: Does not exist 1: Stopped 2: Empty 3: Available 4: Full/Override 5: Full/Stopped 6 – 255: Reserved	-

Attribute	Name	NV	Access	Data type	Description	Default
9 (0x09)	Logged Data Configuration	NV	Get / Set	BYTE	Configures which data is stored in the event log. Bit 0 = 0: Enter event without time value Bit 0 = 1: Enter event with time value Bits 1 – 7: Reserved (always 0).	0
10 (0x0A)	Log Full Action	NV	Get / Set	USINT	Configures what to do when a new event is detected and the log is full. 0: Stop 1: Scroll 2 – 255: Reserved	1
11 (0x0B)	Duplicate Event Action	NV	Get / Set	USINT	Configures what to do when a double event is detected. 0: Ignore 1: Add 2 – 255: Reserved	1
12 (0x0C)	Event/Data Log Maximum Size	V	Get	UDINT	Max. Number of allowed entries in the event log.	8
13 (0x0D)	Event/Data Log Size	V	Get	UDINT	The current number of entries in the event log. Values: 0 to maximum (= value of the attribute 12).	0
14 (0x0E)	Event/Data Log	V	Get Get Member Remove Member	ARRAY of STRUCT	List of all registered events. An entry contains the IO-Link Event Qualifier (USINT) and the IO-Link Event Code (UINT). Attribute 9 specifies whether a time stamp (STIME) is also entered. The structure of an entry is described below.	0
19 (0x13)	Log Full	V	Get	BOOL	Log full? Incorrect: Log not full True: Log full	Wrong
20 (0x14)	Log Contains Entries	V	Get	BOOL	Log contains entries? False: Log is empty. True—Log contains events.	Wrong
21 (0x15)	Log Overrun	V	Get	BOOL	Log Overflow? False: No Log Overflow True - Log Overflow	Wrong
22 (0x16)	Sequential Event/Data Access	V	Get	STRUCT	Easy read access to event entries. If there are one or more entries in the event log, get_attribute_Single reads the first entry, which is then removed from the event log. If there is no entry in the event log, get_attribute_Single does not return any data.	-
24 (0x18)	Event Identifier Format	NV	Get / Set	USINT	Format of a log entry 0 – 3: Reserved 4: 24 bits in the format USINT + UINT 5 – 255: Reserved	4

Table 97: Instance attributes event log object 65 (0x41)

### Attribute 14: Structure of a log entry

The value of attribute 9 determines the structure of a log entry.

Structure of a log entry	Description
USINT	IO-Link Event Qualifier, always available.
UINT	IO-Link Event Code, always available.
STIME	System time The system time is available only if attribute 9 bit 0 = 1.

Table 98: Structure of a log entry

### Services

Service code	Service name	Class level	Instance level	Description
5 (0x05)	Reset	-	Yes	Reset
14 (0x0E)	Get Attribute Single	Yes	Yes	Read an attribute
16 (0x10)	Set Attribute Single	-	Yes	Write an attribute value
24 (0x18)	Get Member	-	Yes	Read the entry
27 (0x1B)	Remove Member	-	Yes	Delete entry

Table 99: Services Event Log Object 65 (0x41)

## 11.2.2 CIP status

CIP status	Description
0 (0x00)	Success The addressed object has successfully performed the service.
1 (0x01)	Connection failure A connection-related service failed. The error may have occurred anywhere along the connection path.
2 (0x02)	Resource not available Some resources the object needs to perform the service are not available.
3 (0x03)	Invalid parameter value See CIP status 32 (0x20).
4 (0x04)	Path segment error A path segment error has occurred. The path information could not be evaluated.
5 (0x05)	Path destination unknown The addressed CIP class or CIP instance is unknown.
6 (0x06)	Partial transfer Only a part of the data could be transferred.
7 (0x07)	Connection lost The connection for messaging has been lost.
8 (0x08)	Service not supported The required service has not been defined or implemented for this object class or instance.
9 (0x09)	Invalid attribute value Detection of invalid attribute data.
10 (0x0A)	Attribute list error An attribute in the response "Get_Attribute_List" or "Set_Attribute_List" has a status not equal to 0.
11 (0x0B)	Already in requested mode/state The object is already in the mode or state requested by the service.

CIP status	Description
12 (0x0C)	Object state conflict The object is not able to perform the requested service in the current mode or state.
13 (0x0D)	Object exists already It has been tried to create an instance of an existing object.
14 (0x0E)	Attribute not settable It has been tried to change a non-modifiable attribute.
15 (0x0F)	Violation of rights The check of authorizations or rights failed.
16 (0x10)	Device state conflict The current mode or state of the device prevents the execution of the requested service.
17 (0x11)	Reply data too large The data to be transmitted requires more space than the allocated response buffer has.
18 (0x12)	Fragmentation of a primitive value The service specifies a function to fragment a primitive data value (e.g. to halve a REAL data type) and can thus not be executed.
19 (0x13)	Not enough data The service did not supply all required data to perform the specified operation.
20 (0x14)	Attribute not supported An unsupported attribute has been specified in the request.
21 (0x15)	Too much data The service supplied more data than expected.
22 (0x16)	Object does not exist The specified object does not exist in the device.
23 (0x17)	Service fragmentation sequence not in progress The fragmentation sequence for this service is currently not active for this data.
24 (0x18)	No stored attribute data The attribute data for this object has not been saved before requesting the service.
25 (0x19)	Saving attempt failed The attribute data of the object could not be saved because an error occurred during the attempt to save the data.
26 (0x1A)	Routing failure, request packet too large The routing device had to abort the service because the request packet of this service was too large for the transmission in the network on the path to the destination.
27 (0x1B)	Routing failure, response packet too large The routing device had to abort the service because the response packet of this service was too large for the transmission in the network on the path from the destination.
28 (0x1C)	Missing entry data in attribute list The service could not supply an attribute of an attribute list that it needs to perform the requested behavior.
29 (0x1D)	Invalid attribute value list The service returns a list of attributes containing the status information "invalid attributes".

CIP status	Description
30 (0x1E)	Embedded service error If the embedded service is an IO-Link service: The IO-Link-specific error codes within the CIP data provide further information of the IO-Link master or IO-Link-Device.
31 (0x1F)	Vendor-specific error A Vendor-specific error has occurred. This Vendor-specific error occurs if none of the general error codes can be used.
32 (0x20)	Invalid parameter A parameter of the request is invalid because it does not meet the requirements of the CIP specification and/or the requirements defined in the specification of an application object.
33 (0x21)	Write-once value or medium already written An attempt was made to modify the values of a medium that have already been written and cannot be written a second time.
34 (0x22)	Invalid reply received An invalid reply has been received because, e.g., a reply service code does not match the request service code or because the reply is shorter than the expected minimum size.
35 (0x23) – 36 (0x24)	Reserved Reserved for future extensions of the CIP standard.
37 (0x25)	Error in the key segment The key segment (the first segment in the path) does not match the destination module. More information about which part of the key check failed, see object status.
38 (0x26)	Path size invalid The path to an object cannot be routed due to lacking information or too much routing data.
39 (0x27)	Unexpected attribute in list The attempt has been made to set an attribute that must not be set in the current situation.
40 (0x28)	Invalid member ID The member ID specified in the request is not available in the class/ instance or attribute.
41 (0x29)	Member cannot be modified A request has occurred to modify a member that cannot be modified.
42 (0x2A)	General error in "Group 2 only server" This DeviceNet-specific error cannot occur in EtherNet/IP.
43 (0x2B) – 207 (0xCF)	Reserved Reserved for future extensions of the CIP standard.
208 (0xD0) – 255 (0xFF)	Reserved for object class and service errors An object-class-specific error has occurred.

Table 100: Error codes (CIP status)

## 11.3 Diagnosis over IO-Link

### 11.3.1 Event Qualifier

The Event Qualifier is a bit-coded information about the event.

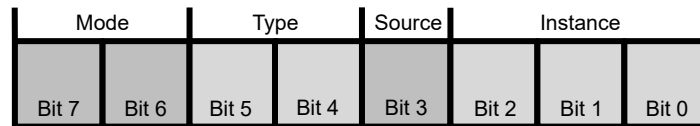

Figure 53: Event Qualifier

Bit	Name	Description
Bit 6–7	Mode	0: reserved 1: Event single shot 2: Event disappears 3: Event appears
Bit 4–5	Type	0: reserved 1: Notification 2: Warning 3: Error
Bit 3	Source	0: Device (remote) 1: Master/Port
Bit 0–2	Instance	0: unknown 1–3: reserved 4: Application 5–7: reserved

Table 101: Event Qualifier

### 11.3.2 IO-Link Wireless Master Event Codes

Event code	Description	Type	Remedy
0x0000	No malfunction	Notification	No action required
0xFF21	Communication to Wireless Device (IO-Link Device is connected to Bridge)	Event	No action required
0xFF22	Communication loss to IO-Link Device (IO-Link Device is disconnected from Bridge)	Error	Check connection from IO-Link Device to the Bridge
0xFFB1	Max Retry error, indicating a packet loss The W-Master cannot send a message to W-Device after MaxRetry attempts.  This error indicates that one packet failed to be transmitted successfully. This can be for example the result of a noisy environment (RF-wise). It affects the PER (Packet Error Ratio) of the system.	Error	An excessive PER requires a check of the system configuration (ranges, operating channels, etc.).
0xFFB2	IMA timeout The W-Master did not receive a message from the connected W-Device within the IMA timeout. This error indicates that the IOLW connection failed. Possibly this leads to "Communication loss" 0xFF22.	Error	Check connection from IO-Link Device to the Bridge

Table 102: IO-Link Wireless Master Event Codes

### 11.3.3 IO-Link Device Event Codes (common)

An IO-Link device connected to the IO-Link master via a port can also trigger events. An IO-Link device sends the "event code" and the "event qualifier" of the event to the IO-Link master. The following values are set in the event qualifier:

```
TYPE = 1 (Notification)
MODE = 1 (Single shot)
SOURCE = 0 (Device/remote)
```

The IO-Link master sends this event to the which can report that as an emergency to the . The IODD of the IO-Link device contains manufacturer-specific events with message text.

The following table lists standard IO-Link Device Event Codes. For device-specific Event Codes or remedy, use the manual of the used IO-Link Device.

Event code	Description	Type	Remedy (common)
0x0000	No malfunction	Notification	No action required
0x1000	General malfunction (unknown error)	Error	See manual of the used IO-Link Device
0x1800 – 0x18FF	Vendor-specific	-	See manual of the used IO-Link Device
0x4000	Temperature fault – overload	Error	Check temperature, find source for overload
0x4210	Device temperature overrun	Warning	Clear source of heat
0x4220	Device temperature underrun	Warning	Insulate IO-Link Device
0x5000	Device hardware fault	Error	Exchange IO-Link Device
0x5010	Component malfunction	Error	Repair or exchange
0x5011	Non-volatile memory loss	Error	Check batteries
0x5012	Batteries low	Warning	Exchange batteries
0x5013	HMI button pressed	Notification	-
0x5100	General power supply fault	Error	Check availability of power supply
0x5101	Fuse blown/open	Error	Exchange fuse
0x5110	Primary supply voltage overrun	Warning	Check tolerance of 1L+ voltage
0x5111	Primary supply voltage underrun	Warning	Check tolerance of 1L+ voltage
0x5112	Secondary supply voltage fault (Port Class B)	Warning	Check tolerance of 2L+ voltage
0x6000	Device software fault	Error	Check firmware revision
0x6320	Parameter error	Error	Check data sheet and values
0x6321	Parameter missing	Error	Check data sheet
0x6350	Parameter changed	Error	Check configuration
0x7700	Wire break of a subordinate device	Error	Check installation
0x7701 – 0x770F	Wire break of subordinate device 1 ... device 15	Error	Check installation
0x7710	Short circuit	Error	Check installation
0x7711	Ground fault	Error	Check installation
0x8C00	Technology-specific application fault	Error	Reset Device
0x8C01	Simulation active	Warning	Check operational mode
0x8C10	Process variable range overrun – Process Data uncertain	Warning	Check configuration of device
0x8C20	Measurement range exceeded	Error	Check application



Event code	Description	Type	Remedy (common)
0x8C30	Process variable range underrun – Process Data uncertain	Warning	Check configuration of device
0x8C40	Maintenance required	Warning	Clean
0x8C41	Maintenance required	Warning	Refill
0x8C42	Maintenance required	Warning	Exchange wear and tear parts
0x8CA0 – 0x8DFF	Vendor-specific	-	See manual of the used IO-Link Device
0xB000 – 0xB0FF	Safety extensions	-	See manual of the used IO-Link Device
0xB100 – 0xBFFF	Profile-specific	-	See manual of the used IO-Link Device
0xFF91	Internal Data Storage upload request	Notification (single shot)	See manual of the used IO-Link Device
0xFFB9	Retry error	Error	See manual of the used IO-Link Device
Any other code	Reserved	-	See manual of the used IO-Link Device

Table 103: IO-Link Device Event Codes (common)

## 12 Technical data

### 12.1 Technical data device

Category	Parameter	Value			
Product	Part number	1912.122			
	Model	NFD-3090-EIS-IOLMW			
	Description	netFIELD IO-Link Wireless Master EtherNet/IP Adapter			
	Function	IO-Link Master Wireless for EtherNet/IP with 2 tracks for up to 16 channels			
Communication controller	Type	netX 90			
Integrated memory	RAM	16 MB SDRAM			
	FLASH	8 MB			
Ethernet communication	Real-Time Ethernet	EtherNet/IP Adapter			
Ethernet interface	Interface type	100BASE-TX, 10BASE-T, isolated			
	Auto-negotiation, Auto crossover	yes			
	Connectors	X31: Ethernet interface, M12, D-coded, EtherNet/IP port 1 X32: Ethernet interface, M12, D-coded, EtherNet/IP port 2			
LEDs	System and application	SYS	System status	green/yellow	
		APL	Application status	red/green	
	Power supply	1L (X21)	1L power supply (DC 24 V)		red/green
		2L (X21)	2L power supply (DC 24 V)		red/green
	EtherNet/IP communication	MS	Module status		red/green
		NS	Network status		red/green
	Ethernet	LINK (X31)	Link status, connector X31		green
		ACT (X31)	Activity status, connector X31		yellow
		LINK (X32)	Link status, connector X32		green
		ACT (X32)	Activity status, connector X32		yellow
	Wireless tracks	WT01 ... WT03	IO-Link wireless track status, antenna X1 ... X3		red/yellow/green
	Wireless ports	WP01 ... WP08	Port status, wireless IO-Link ports 1 to 8		red/yellow/green
		WP09 ... WP16	Port status, wireless IO-Link ports 9 to P16		red/yellow/green
	Power supply 1L, 2L	Voltage supply	24V DC, -25%/+30% (18 V DC ... 31.2 V DC)		
Power consumption		1L: 0.2 A (at 24 V DC), 2L: 0.1 A (at 24 V DC)			
Connectors		X21: Power supply input (Power In), M12, L-coded X22: Power supply output (Power Out), M12, L-coded			
Power consumption (power connectors)		Max. 16 A, Max. current of the device including pass through must not exceed 16 A for 1L and 2L. Observe derating for the maximum current depending on the ambient temperature.			
Revers polarity protection		Yes			

Category	Parameter	Value
Ambient conditions	Ambient temperature (operation), Air flow, during measurement	-25 °C ... +70 °C, V ≤ 0,5 m/s
	Ambient temperature (storage)	-40 °C ... +85 °C
	Max. temperature change	3 K / min
	Humidity	5 ... 95% relative humidity, no condensation permitted
	Operating height	0 ... 2000 m
	Over voltage category	II (EN 60664-1)
	Device	Dimensions (L x W x H)
Housing		Plastics
Weight		212 g, with 3 antennas: 227 g
Mounting/installation		Screw mounting, with 2x M4 screws to the 2 mounting holes. The upper screw makes contact to FE (functional earth).
Tightening torque		1.2 Nm
Protection class		IP67
Conformity	RoHS	EN IEC 63000:2018 / BS EN IEC 63000:2018
Compliance with EMC	CE sign	yes
	UKCA sign	yes
Approvals	FCC	FCC ID: 2ANEG002
	ISED	IC ID: 24152-0002
	RED	Certificate: In preparation
Firmware download	Web pages	netFIELD Wireless Web Server
Configuration	Software	EtherNet/IP Scanner, netFIELD Wireless Web Server, IO-Link ET

Table 104: Technical data NFD-3090-EIS-IOLMW

Category	Parameter	Value
Product data	Name	Wifi Antenna 2.4G rubber antenna
	Model	TLW2.5A-SMA-Male
	Type	Monopole whip antenna
	Manufacturer	Silram Technologies Ltd., Kfar Saba, Israel
Electrical specifications	Frequency Range	2400-2500 MHz
	Gain	1.6 dBi
	Polarization	Vertical
	Radiation	Omni
Mechanical specifications	Connector	Regular SMA-Male
	Height	25.6 mm

Table 105: Technical data SMA antenna

## 12.2 Technical data IO-Link Wireless Master

Parameter	Value
Tracks and IO-Link Devices	2 wireless tracks for up to 16 IO-Link Devices
Radio frequencies	RFch (RF channel center frequency): 2403 ... 2478 MHz (wireless channels 3 – 78, configurable). The IO-Link Wireless Master uses the frequencies (wireless channels) 2401 (1), 2402 (2), 2479 (79), 2480 (80) for network configurations purposes and cannot be configured for communication purposes.
Range of the wireless function	Max. 10 m distance
Masters per cell	Max. 3 masters within a circle of 20 m diameter
Antennas	3 SMA antennas

Table 106: Technical data IO-Link Wireless Master

### 12.3 Technical data protocol

Parameter	Value
Connection 1 "Exclusive Owner – 8 ports x 32 bytes	Input data: 276 bytes, Output data: 276 bytes
Connection 2 "Exclusive Owner – 8 ports x 32 bytes w/o Config	
Connection 3 "Listen Only – 8 ports x 32 bytes	Input data: 276 bytes, output data: 0 bytes
Connection 4 "Input Only – 8 ports x 32 bytes	
Connection 5 "Exclusive Owner - 16 ports x 16 bytes w/o Config	Input data: 292 bytes, Output data: 292 bytes
Connection 6 "Listen Only - 16 ports x 16 bytes	
Connection 7 "Input Only - 16 ports x 16 bytes	Input data: 292 bytes, output data: 0 bytes
Connection 8 "Exclusive Owner - 16 ports x 4 bytes w/o Config	
Connection 9 "Listen Only - 16 ports x 4 bytes	Input data: 100 bytes, Output data: 100 bytes
Connection 10 "Input Only - 16 ports x 4 bytes	
I/O connection types (implicit)	Exclusive owner Owner Input Only Listen Only
I/O connection trigger type	Cyclic
Maximum number of I/O connections (class 1)	3
Maximum number of message connections (class 3)	6
Predefined standard objects	Identity Object (0x01) Message Router Object (0x02) Assembly Object (0x04) Connection Manager (0x06) Event Log Object (0x41) DLR Object (0x47) QoS Object (0x48) TCP/IP Interface Object (0xF5) Ethernet Link Object (0xF6)
DHCP	Supported (factory setting)
BOOTP	Supported
Fixed IP address	Supported
Duplex mode	Half duplex, full duplex, auto-negotiation
MDI mode	MDI, MDI-X, Auto-MDIX
ACD (Address Conflict Detection)	Supported
Integrated switch	Supported
Reset services	CIP reset services: Identity Object, Reset Services Type 0 and 1
Data transport layer	Ethernet II, IEEE 802.3
Interface type	10BASE-T, 100BASE-TX, isolated

Table 107: Technical data EtherNet/IP Adapter

## 12.4 Technical data netFIELD Wireless Web Server

Parameter	Value
HTTP	HTTP/1.1
Port	80
Connections	Max. 8 simultaneous connections One connection is being processed.
JavaScript	Required
HTTPS	Not supported

Table 108: Technical Data Web Server

## 12.5 OPC UA Server

Parameter	Description
OPC UA Server	According to "IO-Link Companion Specification": <a href="http://opcfoundation.org/UA/IOLink/">http://opcfoundation.org/UA/IOLink/</a> Vendor-specific information model: <a href="http://www.hilscher.com/UA/IOLink/Wireless">http://www.hilscher.com/UA/IOLink/Wireless</a>
Server profile	Micro Embedded Device
Protocol	OPC UA TCP
User access	Anonymous (Read access only) User name / password (Read and write access)
Number of sessions	2
Number subscriptions per session	2
Number „Monitored Items“ per session	20
Data coding	UA binary

Table 109: OPC UA Server

## 12.6 MQTT Client

Parameter	Description
MQTT	Client
Client services	Publish
Protocols	MQTT over TCP
Topic size	Max. 256 bytes individually per MQTT publication and up to 256 bytes of common topic prefix of the associated MQTT connection
Topics	Topic: Printable UTF-8 string, NUL-terminated, multi-byte encoding (MBCS) Payload: JSON
Will Topic	Max. 256 bytes
Quality of Service	QoS 0, QoS 1, and QoS 2
IP standard	IPv4
Port	1883 (default), MQTT unencrypted
MQTT standard	V3.1.1
Restriction	The Subscribe service is not supported.

Table 110: Technical data MQTT Client



# 14 Approvals

## 14.1 FCC/ISED

**CAUTION:** Any changes or modifications not expressly approved by the manufacturer could void the user's authority to operate the equipment.

### The FCC Wants You to Know

This equipment has been tested and found to comply with the limits for a Class A digital device, pursuant to Part 15 of the FCC rules. These limits are designed to provide reasonable protection against harmful interference when the equipment is operated in a commercial environment.

This equipment generates, uses and can radiate radio frequency energy and, if not installed and used in accordance with the instructions, may cause harmful interference to radio communications.

Operation of this equipment in a residential area is likely to cause harmful interference, in which case the user will be required to correct the interference at his own expense.

### FCC Warning

Hilscher Gesellschaft für Systemautomation mbH has not approved any changes or modifications to this device by the user. Any changes or modifications could void the user's authority to operate the equipment.

### ISED Warning

Hilscher Gesellschaft für Systemautomation mbH n'approuve aucune modification apportée à l'appareil par l'utilisateur, quelle qu'en soit la nature. Tout changement ou modification peuvent annuler le droit d'utilisation de l'appareil par l'utilisateur.

### Interference statement

This device complies with Part 15 of the FCC Rules and Industry Canada licence-exempt RSS standard(s). Operation is subject to the following two conditions: (1) This device may not cause interference, and (2) this device must accept any interference, including interference that may cause undesired operation of the device.

Le présent appareil est conforme aux CNR d'Industrie Canada applicables aux appareils radio exempts de licence. L'exploitation est autorisée aux deux conditions suivantes : (1) l'appareil ne doit pas produire de brouillage, et (2) l'utilisateur de l'appareil doit accepter tout brouillage radioélectrique subi, même si le brouillage est susceptible d'en compromettre le fonctionnement.



**Wireless notice**

This device complies with FCC/ISED radiation exposure limits set forth for an uncontrolled environment and meets the FCC radio frequency (RF) Exposure Guidelines and RSS-102 of the ISED radio frequency (RF) Exposure rules. This transmitter must not be co-located or operating in conjunction with any other antenna or transmitter.

Le présent appareil est conforme à l'exposition aux radiations FCC / ISED définies pour un environnement non contrôlé et répond aux directives d'exposition de la fréquence de la FCC radiofréquence (RF) et RSS-102 de la fréquence radio (RF) ISED règles d'exposition. L'émetteur ne doit pas être colocalisé ni fonctionner conjointement avec à autre antenne ou autre émetteur.

# 15 Appendix

## 15.1 References

### **IO-Link Wireless**

IO-Link Community, IO-Link Wireless System Extensions, Specification, Version 1.1, March 2018, Order No: 10.112

### **IO-Link**

IO-Link Community, JSON Integration for IO-Link, Specification, Version 1.0.0, March 2020, Order No: 10.222

### **IO-Link ET**

Hilscher Gesellschaft für Systemautomation mbH: Operating instruction manual, IO-Link ET, Configuring IO-Link Master and IO-Link Devices, DOC211103OI02EN, English, 2023-09

### **Documentation on Wireless Bridge**

Hilscher Gesellschaft für Systemautomation mbH: User manual, netFIELD Device Wireless Bridge, NFD-BRIDGE-IOLSA\W, DOC2110904UMxxEN, English, 2022-xx

### **Safety standards**

American National Standards Institute, Inc.: American National Standard, Product Safety Information in Product Manuals, Instructions, and Other Collateral Materials, ANSI Z535.6-2016, English, 2016.

DIN Deutsches Institut für Normung e. v. and VDE Verband der Elektrotechnik Elektronik Informationstechnik e. V.: German standard, Equipment for audio/video, information and communication technology - Part 1: Safety requirements, (IEC 62368-1:2014, modified + Cor.:2015); English version EN 62368-1:2014 + AC:2015, English, 2016-05.

## 15.2 Conventions in this manual

### Instructions for action and results

1. Operate purpose
2. Operate purpose
  - Instructions for action
  - ⇒ Intermediate result
  - ⇒ Final result

### Signs and signal words







Sign	Description
	General note
	Important note that must be followed to prevent malfunctions
	Reference on further information (acc. to ISO 7010 M001)
	Caution is necessary when operating the device.
	Warning of hazardous voltage! (acc. to ISO 7010 W012) Danger to life, risk of injury by electric shock
	<b>USA:</b> Warning of hazardous voltage! (acc. to ANSI Z535.4) Danger to life, risk of injury by electric shock
	Warning of hot surface

Table 111: Signs

Signal word	Description
<b>DANGER</b>	Indicates a hazardous situation, which if not avoided, will result in death or serious injury.
<b>WARNING</b>	Indicates a hazardous situation, which if not avoided, could result in death or serious injury.
<b>CAUTION</b>	Indicates a hazardous situation, which if not avoided, may result in minor or moderate injury.
<b>NOTICE</b>	Indicates a property damage message.

Table 112: Signal words

## 15.3 Directives and standards

The following table lists the directives and standards applicable to the netFIELD IO-Link Wireless Master EtherNet/IP Adapter NFD-3090-EIS-IOLM/W device.

	European Union	United Kingdom
<b>Directives/ statutory instrument</b>	2014/53/EU RED Directive, 2014/30/EU EMC Directive, 2011/65/EU RoHS Directive changed by directive 2015/863/EU amending annex II	Electromagnetic Compatibility Regulations 2016, Radio Equipment Regulation 2017, Electrical Equipment (Safety) Regulation 2016, The Restriction of the Use of Certain Hazardous Substances in Electrical and Electronic, Equipment Regulations 2012
<b>Emission</b>	EN IEC 61000-6-3	BS EN IEC 61000-6-3
Electromagnetic compatibility of multimedia equipment	EN 55032:2015	BS EN 55032:2015
ElectroMagnetic Compatibility (EMC) standard for radio equipment and services	ETSI EN 301489-1 V2.2.3	ETSI EN 301489-1 V2.2.3
Part 17: Specific conditions for Broadband Data Transmission Systems	ETSI EN 301489-17 V3.2.4	ETSI EN 301489-17 V3.2.4
Human exposure restrictions for electromagnetic fields	EN IEC 62311:2020, EN 62479:2010 (German Version)	BS EN IEC 62311:2020, BS EN 62479:2010
<b>Immunity</b>	EN 61000-6-2:2019-11	BS EN 61000-6-2:2019-11
<ul style="list-style-type: none"> <li>• Electrostatic discharge (ESD) (air and contact discharge method)</li> <li>• Radiated immunity</li> <li>• Fast transient interferences (Burst)</li> <li>• Surge immunity</li> <li>• Conducted immunity</li> </ul>	<ul style="list-style-type: none"> <li>• EN 61000-4-2</li> <li>• EN 61000-4-3</li> <li>• EN 61000-4-4</li> <li>• EN 61000-4-5</li> <li>• EN 61000-4-6</li> </ul>	<ul style="list-style-type: none"> <li>• BS EN 61000-4-2</li> <li>• BS EN 61000-4-3</li> <li>• BS EN 61000-4-4</li> <li>• BS EN 61000-4-5</li> <li>• BS EN 61000-4-6</li> </ul>
<b>General EMC Standards</b>		
Wideband transmission systems	ETSI EN 300328 V2.2.2	ETSI EN 300328 V2.2.2
<b>Safety standards</b>		
Audio/video, information and communication technology equipment - Part 1: Safety requirements	EN 62368-1: 2020+A11:2020	BS EN 62368-1: 2020+A11:2020

Table 113: Directives and standards netFIELD IO-Link Wireless Master device

## 15.4 Legal notes

### Copyright

© Hilscher Gesellschaft für Systemautomation mbH

All rights reserved.

The images, photographs and texts in the accompanying materials (in the form of a user's manual, operator's manual, Statement of Work document and all other document types, support texts, documentation, etc.) are protected by German and international copyright and by international trade and protective provisions. Without the prior written consent, you do not have permission to duplicate them either in full or in part using technical or mechanical methods (print, photocopy or any other method), to edit them using electronic systems or to transfer them. You are not permitted to make changes to copyright notices, markings, trademarks or ownership declarations. Illustrations are provided without taking the patent situation into account. Any company names and product designations provided in this document may be brands or trademarks by the corresponding owner and may be protected under trademark, brand or patent law. Any form of further use shall require the express consent from the relevant owner of the rights.

### Important notes

Utmost care was/is given in the preparation of the documentation at hand consisting of a user's manual, operating manual and any other document type and accompanying texts. However, errors cannot be ruled out. Therefore, we cannot assume any guarantee or legal responsibility for erroneous information or liability of any kind. You are hereby made aware that descriptions found in the user's manual, the accompanying texts and the documentation neither represent a guarantee nor any indication on proper use as stipulated in the agreement or a promised attribute. It cannot be ruled out that the user's manual, the accompanying texts and the documentation do not completely match the described attributes, standards or any other data for the delivered product. A warranty or guarantee with respect to the correctness or accuracy of the information is not assumed.

We reserve the right to modify our products and the specifications for such as well as the corresponding documentation in the form of a user's manual, operating manual and/or any other document types and accompanying texts at any time and without notice without being required to notify of said modification. Changes shall be taken into account in future manuals and do not represent an obligation of any kind, in particular there shall be no right to have delivered documents revised. The manual delivered with the product shall apply.

Under no circumstances shall Hilscher Gesellschaft für Systemautomation mbH be liable for direct, indirect, ancillary or subsequent damage, or for any loss of income, which may arise after use of the information contained herein.

### Liability disclaimer

The hardware and/or software was created and tested by Hilscher Gesellschaft für Systemautomation mbH with utmost care and is made available as is. No warranty can be assumed for the performance or flawlessness of the hardware and/or software under all application conditions and scenarios and the work results achieved by the user when using the hardware and/or software. Liability for any damage that may have occurred as a result of using the hardware and/or software or the corresponding documents shall be limited to an event involving willful intent or a grossly negligent violation of a fundamental contractual obligation. However, the right to assert damages due to a violation of a fundamental contractual obligation shall be limited to contract-typical foreseeable damage.

It is hereby expressly agreed upon in particular that any use or utilization of the hardware and/or software in connection with

- Flight control systems in aviation and aerospace;
- Nuclear fission processes in nuclear power plants;
- Medical devices used for life support and
- Vehicle control systems used in passenger transport

shall be excluded. Use of the hardware and/or software in any of the following areas is strictly prohibited:

- For military purposes or in weaponry;
- For designing, engineering, maintaining or operating nuclear systems;
- In flight safety systems, aviation and flight telecommunications systems;
- In life-support systems;
- In systems in which any malfunction in the hardware and/or software may result in physical injuries or fatalities.

You are hereby made aware that the hardware and/or software was not created for use in hazardous environments, which require fail-safe control mechanisms. Use of the hardware and/or software in this kind of environment shall be at your own risk; any liability for damage or loss due to impermissible use shall be excluded.

## Warranty

Hilscher Gesellschaft für Systemautomation mbH hereby guarantees that the software shall run without errors in accordance with the requirements listed in the specifications and that there were no defects on the date of acceptance. The warranty period shall be 12 months commencing as of the date of acceptance or purchase (with express declaration or implied, by customer's conclusive behavior, e.g. putting into operation permanently).

The warranty obligation for equipment (hardware) we produce is 36 months, calculated as of the date of delivery ex works. The aforementioned provisions shall not apply if longer warranty periods are mandatory by law pursuant to Section 438 (1.2) BGB, Section 479 (1) BGB and Section 634a (1) BGB [Bürgerliches Gesetzbuch; German Civil Code] If, despite of all due care taken, the delivered product should have a defect, which already existed at the time of the transfer of risk, it shall be at our discretion to either repair the product or to deliver a replacement product, subject to timely notification of defect.

The warranty obligation shall not apply if the notification of defect is not asserted promptly, if the purchaser or third party has tampered with the products, if the defect is the result of natural wear, was caused by unfavorable operating conditions or is due to violations against our operating regulations or against rules of good electrical engineering practice, or if our request to return the defective object is not promptly complied with.

## Costs of support, maintenance, customization and product care

Please be advised that any subsequent improvement shall only be free of charge if a defect is found. Any form of technical support, maintenance and customization is not a warranty service, but instead shall be charged extra.

## Additional guarantees

Although the hardware and software was developed and tested in-depth with greatest care, Hilscher Gesellschaft für Systemautomation mbH shall not assume any guarantee for the suitability thereof for any purpose that was not confirmed in writing. No guarantee can be granted whereby the hardware and software satisfies your requirements, or the use of the hardware and/or software is uninterrupted or the hardware and/or software is fault-free.

It cannot be guaranteed that patents and/or ownership privileges have not been infringed upon or violated or that the products are free from third-party influence. No additional guarantees or promises shall be made as to whether the product is market current, free from deficiency in title, or can be integrated or is usable for specific purposes, unless such guarantees or promises are required under existing law and cannot be restricted.

## **Confidentiality**

The customer hereby expressly acknowledges that this document contains trade secrets, information protected by copyright and other patent and ownership privileges as well as any related rights of Hilscher Gesellschaft für Systemautomation mbH. The customer agrees to treat as confidential all of the information made available to customer by Hilscher Gesellschaft für Systemautomation mbH and rights, which were disclosed by Hilscher Gesellschaft für Systemautomation mbH and that were made accessible as well as the terms and conditions of this agreement itself.

The parties hereby agree to one another that the information that each party receives from the other party respectively is and shall remain the intellectual property of said other party, unless provided for otherwise in a contractual agreement.

The customer must not allow any third party to become knowledgeable of this expertise and shall only provide knowledge thereof to authorized users as appropriate and necessary. Companies associated with the customer shall not be deemed third parties. The customer must obligate authorized users to confidentiality. The customer should only use the confidential information in connection with the performances specified in this agreement.

The customer must not use this confidential information to his own advantage or for his own purposes or rather to the advantage or for the purpose of a third party, nor must it be used for commercial purposes and this confidential information must only be used to the extent provided for in this agreement or otherwise to the extent as expressly authorized by the disclosing party in written form. The customer has the right, subject to the obligation to confidentiality, to disclose the terms and conditions of this agreement directly to his legal and financial consultants as would be required for the customer's normal business operation.

## **Export provisions**

The delivered product (including technical data) is subject to the legal export and/or import laws as well as any associated regulations of various countries, especially such laws applicable in Germany and in the United States. The products / hardware / software must not be exported into such countries for which export is prohibited under US American export control laws and its supplementary provisions. You hereby agree to strictly follow the regulations and to yourself be responsible for observing them. You are hereby made aware that you may be required to obtain governmental approval to export, reexport or import the product.



## 15.5 Registered trademarks

EtherNet/IP™ is a trademark of the ODVA (Open DeviceNet Vendor Association, Inc.).

IO-Link™ and IO-Link wireless™ are trade names of the “IO-Link Community”.

All other brands mentioned are property of their respective owner of the rights. Any company names and product designations provided in this document may be brands (company names or trademarks) of the corresponding owner and may be protected under trademark or patent law.

## List of figures

Figure 1:	Device overview, NFD-3090-EIS-IOLMW .....	7
Figure 2:	QR code (example) .....	10
Figure 3:	Derating netFIELD IO-Link Wireless Master device .....	12
Figure 4:	Connection example with W-Bridge .....	22
Figure 5:	Dashboard page (example) .....	36
Figure 6:	Menu item SignIn - Input mask for user name and password .....	37
Figure 7:	User Administration screen mask (initial state) .....	38
Figure 8:	User Administration screen mask .....	39
Figure 9:	Device configuration tab (example) .....	40
Figure 10:	Maintenance information tab .....	41
Figure 11:	Firmware update tab (example) .....	42
Figure 12:	Firmware update is performed (example) .....	43
Figure 13:	Factory reset tab .....	44
Figure 14:	MQTT tab, Client Status, Client Configuration sub tab (example) .....	45
Figure 15:	MQTT tab, Connection1 > IP settings sub sub tab (example) .....	46
Figure 16:	MQTT tab, Connection1 > Session settings sub sub tab (example) .....	47
Figure 17:	MQTT tab, Connection1 > Will settings sub sub tab (example) .....	48
Figure 18:	MQTT tab, Connection1 > Advanced settings sub sub tab (example) .....	49
Figure 19:	Channel selection tab .....	51
Figure 20:	Channel selection tab, Expert settings (example) .....	53
Figure 21:	IO-Link Wireless Master > Configuration tab .....	54
Figure 22:	Scan tab .....	56
Figure 23:	“Scan tab”, scan result .....	56
Figure 24:	Diagnostics tab .....	58
Figure 25:	Information tab, Device information (example) .....	60
Figure 26:	Status tab, Port status and Quality status (example) .....	61
Figure 27:	Settings tab, Port Mode sub tab (example) .....	63
Figure 28:	Settings tab, Validation level sub tab (example) .....	64
Figure 29:	Settings tab, Transmission sub tab (example) .....	65
Figure 30:	Settings tab, Miscellaneous sub tab (example) .....	67
Figure 31:	Pairing tab after port mode was set correctly .....	69
Figure 32:	Pairing successfully finished .....	70
Figure 33:	W-Bridge update tab (example) .....	72
Figure 34:	Device update tab (example) .....	74
Figure 35:	Display of the On Request Data, read/write IO-Link Device parameters .....	76
Figure 36:	Display of the Port process data (example) .....	79
Figure 37:	IO-Link Wireless Master > Configuration tab (example) .....	82
Figure 38:	Scan tab .....	83
Figure 39:	Scan tab with result .....	83
Figure 40:	Settings tab > Port mode sub tab (example) .....	84

---

Figure 41:	Settings tab > Validation level sub tab (example) .....	85
Figure 42:	Settings tab > Transmission sub tab (example) .....	86
Figure 43:	Settings tab > Miscellaneous sub tab (example).....	87
Figure 44:	Tab and table "Port process data" (example PD input valid = OK) .....	88
Figure 45:	Status tab, Port status .....	88
Figure 46:	Information tab, Device information.....	89
Figure 47:	ISDU tab, read/write IO-Link Device parameters .....	91
Figure 48:	Node NtpClientUpdateConfiguration (1).....	95
Figure 49:	Node NtpClientUpdateConfiguration (2).....	96
Figure 50:	Dialog for configuring the NTP client.....	96
Figure 51:	Dialog for configuring the NTP client (successful).....	96
Figure 52:	OPC UA: Information model of the device.....	110
Figure 53:	Event Qualifier .....	135
Figure 54:	Dimensions NFD-3090-EIS-IOLMW device .....	143

## List of tables

Table 1:	List of revisions .....	5
Table 2:	Legend to the device overview, NFD-3090-EIS-IOLMW .....	8
Table 3:	Hardware .....	9
Table 4:	Software.....	9
Table 5:	Firmware.....	9
Table 6:	IO-Link Wireless Master .....	9
Table 7:	Supply voltage .....	11
Table 8:	Ethernet .....	11
Table 9:	SMA antenna type .....	12
Table 10:	Overview for installation and commissioning.....	15
Table 11:	Overview Tool chains 1 and 2 .....	25
Table 12:	Connections.....	27
Table 13:	Parameters 10 to 89 .....	28
Table 14:	Parameters 410 to 566 .....	30
Table 15:	Calculation of the W-Master cycle time of the IO-Link Wireless Master .....	31
Table 16:	Time base of I-Am-Alive time.....	31
Table 17:	Calculation of I-Am-Alive time.....	32
Table 18:	Functional overview of the netFIELD Wireless Web Server for IO-Link Devices ...	34
Table 19:	Data on "Dashboard" page .....	36
Table 20:	Selection list „Configuration control“ .....	40
Table 21:	Device configuration tab- Parameter .....	40
Table 22:	Maintenance information details .....	41
Table 23:	Options to delete settings .....	44
Table 24:	MQTT in port configuration for IO-Link Device, Client Status.....	45
Table 25:	MQTT in port configuration for IO-Link Device, Client Configuration.....	46
Table 26:	MQTT in port configuration for IO-Link Device, Connection1 > IP settings .....	46
Table 27:	MQTT in port configuration for IO-Link Device, Connection1 > Session settings...	47
Table 28:	MQTT in port configuration for IO-Link Device, Connection1 > Will settings.....	48
Table 29:	MQTT in port configuration for IO-Link Device, Connection1 > Advanced settings	49
Table 30:	IO-Link Wireless Master settings - Channel selection .....	51
Table 31:	IO-Link Wireless Master settings - Configuration .....	54
Table 32:	Scan result (pairing).....	56
Table 33:	Diagnostics of wireless master and tracks temperatures .....	58
Table 34:	Port specific tabs .....	59
Table 35:	Information tab, with Device information.....	60
Table 36:	Port status.....	61
Table 37:	Port state values .....	62
Table 38:	Quality status .....	62
Table 39:	Settings in port configuration for IO-Link Device, Port mode sub tab .....	63
Table 40:	Settings in port configuration for IO-Link Device, Validation level sub tab .....	64

Table 41:	Validation and backup, possible values .....	64
Table 42:	Settings in port configuration for IO-Link Device, Transmission sub tab .....	65
Table 43:	Calculation of the W-Master cycle time of the IO-Link Wireless Master .....	66
Table 44:	Settings in port configuration for IO-Link Device, Miscellaneous sub tab .....	67
Table 45:	Icons of parameter comparison .....	73
Table 46:	Metadata of the selected firmware .....	75
Table 47:	Port process data, parameters .....	79
Table 48:	Configuration, possible values for IO-Link Wireless Master (example) .....	82
Table 49:	Scan result values .....	83
Table 50:	Settings > Port mode (example values) .....	84
Table 51:	Settings > Validation level (example values) .....	85
Table 52:	Settings > Transmission (example values) .....	86
Table 53:	Settings > Miscellaneous (example values) .....	87
Table 54:	Track and Slot – example 1 wireless device with slot type “double slot” .....	92
Table 55:	Dialog Add Server - tabs Discovery and Advanced .....	94
Table 56:	Input process data, connection 1 to connection 4 .....	98
Table 57:	Output process data, connection 1 and connection 2 .....	99
Table 58:	Input process data, connection 5 to connection 7 .....	101
Table 59:	Output process data, connection 5 .....	103
Table 60:	Input process data, connection 8 to connection 10 .....	105
Table 61:	Output process data, connection 8 .....	107
Table 62:	Input data status .....	109
Table 63:	Device identification .....	111
Table 64:	Identification of the connected IO-Link Devices .....	111
Table 65:	NTP client configuration .....	112
Table 66:	General parts of a topic .....	113
Table 67:	Gateway topics .....	113
Table 68:	Gateway capabilities, "JSON key" .....	113
Table 69:	Gateway configuration, "JSON key" .....	114
Table 70:	Master topics .....	115
Table 71:	Port list, "JSON key" .....	117
Table 72:	Port capabilities, "JSON key" .....	117
Table 73:	Port status, "JSON key" .....	118
Table 74:	Port configuration, "JSON key" .....	118
Table 75:	Device topics .....	120
Table 76:	Device list (JSON object) .....	120
Table 77:	Device identification (JSON object) .....	121
Table 78:	Device process data (JSON object) .....	122
Table 79:	Device process data input (JSON object) .....	122
Table 80:	Device process data output (JSON object) .....	123
Table 81:	Device events (JSON object) .....	123

Table 82:	MQTT topics .....	124
Table 83:	MQTT configuration, "JSON key" .....	124
Table 84:	MQTT connection status, "JSON key" .....	124
Table 85:	States of the SYS-LED .....	125
Table 86:	Definitions of the states of the SYS LED .....	125
Table 87:	APL LED states .....	126
Table 88:	Supply voltage status 1L and 2L.....	126
Table 89:	Communication status EtherNet/IP Adapter .....	127
Table 90:	Definition LED states communication status .....	128
Table 91:	Ethernet status EtherNet/IP Adapter .....	128
Table 92:	Definition LED states Ethernet status .....	128
Table 93:	Wireless track status WT1 ... WT3.....	129
Table 94:	Wireless port status WP01 ... WP16 .....	129
Table 95:	Class attributes event log object 65 (0x41).....	130
Table 96:	Mapping CIP instances to IO-Link ports .....	130
Table 97:	Instance attributes event log object 65 (0x41).....	130
Table 98:	Structure of a log entry .....	132
Table 99:	Services Event Log Object 65 (0x41) .....	132
Table 100:	Error codes (CIP status) .....	132
Table 101:	Event Qualifier .....	135
Table 102:	IO-Link Wireless Master Event Codes.....	135
Table 103:	IO-Link Device Event Codes (common) .....	136
Table 104:	Technical data NFD-3090-EIS-IOLM\W .....	138
Table 105:	Technical data SMA antenna.....	139
Table 106:	Technical data IO-Link Wireless Master .....	140
Table 107:	Technical data EtherNet/IP Adapter .....	141
Table 108:	Technical Data Web Server.....	142
Table 109:	OPC UA Server .....	142
Table 110:	Technical data MQTT Client .....	142
Table 111:	Signs.....	147
Table 112:	Signal words .....	147
Table 113:	Directives and standards netFIELD IO-Link Wireless Master device .....	148

## Glossary

<b>CIP</b>	Common Industrial Protocol: communication protocol for industrial automation applications, which is supported by the ODVA (Open DeviceNet Vendors Association). The peer to peer object oriented protocol provides connections between industrial devices (sensors, actuators) and higher-level devices (controllers) and is physical media and data link layer independent.
<b>DCP</b>	Discovery and basic configuration protocol: Protocol for identifying and configuring devices, which is defined within the PROFINET specification
<b>DHCP</b>	Dynamic host configuration protocol: protocol simplifying the configuration of IP networks by automatically assigning IP addresses
<b>DHCP server</b>	Provides the assignment of IP address via DHCP protocol as a service to other network participants and facilitates the IP address assignment essentially
<b>EDS</b>	Electronic Data Sheet: external ASCII text file that provides information necessary to access and alter the configurable parameters of a device. The file contains information about the configurable attributes of the device, including object addresses of each parameter. The application objects in a device represent the destination addresses for the configuration data. These addresses are encoded in the EDS.
<b>EtherNet/IP</b>	Communication system for industrial Ethernet designed and developed by Rockwell that uses the CIP (common industrial protocol)
<b>EtherNet/IP Adapter</b>	Exchanges real-time I/O data with a Scanner Class product and does not initiate connections on its own
<b>EtherNet/IP Scanner</b>	Exchanges real-time I/O data with adapters and scanners, can respond to connection requests and also initiate connections on its own
<b>IODD</b>	IO Device Description: Describes sensors and actuators with an IO-Link communication interface
<b>IO-Link</b>	Communication system to connect intelligent sensors and actuators to an automation system standardized in the IEC 61131-9 under the name Single-drop digital communication interface for small sensors and actuators (SDCI).
<b>IO-Link wireless</b>	Extension of the IO-Link base technology for IO-Link wireless communication according to the IO-Link Wireless System Specification

<b>IP</b>	Internet Protocol: Belongs to the TCP/IP family of protocols and is defined in RFC791 (available on <a href="http://www.ietf.org/rfc/rfc791.txt">http://www.ietf.org/rfc/rfc791.txt</a> ). It is based on layer 3 of the ISO/OSI 7 layer model of networking and is a connectionless protocol, i. e. you do not need to open a connection to a computer before sending an IP data packet to it. Therefore, IP is not able to guarantee that the IP data packets really arrive at the recipient. On IP level, neither the correctness of data nor the consistence and completeness are checked. IP defines special addressing mechanisms; see IP address.
<b>IP address</b>	Identifies a device or a computer within an IP-based network and is defined in the Internet Protocol Version 4 (IPv4) as a 32-bit number. For ease of notation, the address is usually divided into four 8-bit numbers represented in decimal notation and separated by points: a.b.c.d. Each letter stands for an integer value between 0 and 255, e.g. 192.168.30.16. However, not all combinations are allowed, some are reserved for special purposes. The IP address 0.0.0.0 is defined as invalid.
<b>ISDU</b>	Indexed Service Data Unit: Used for acyclic transmission of parameters (IO-Link wireless communication)
<b>MAC-ID</b>	Media Access Control-ID: unique (physical) Ethernet address of the device on delivery, defined as 48 bit number; for ease of notation it is divided into six 8 bit numbers which are represented in hexadecimal notation and separated by "minus"-signs (-): A-B-C-D-E-F (A-B-C-D-E-F each are integer values between 0 and 0XFF=255), Example:00-02-A2-20-91-18
<b>MQTT</b>	Message Queuing Telemetry Transport: Publish-subscribe based "light weight" M2M (machine to machine) messaging protocol for use on top of the TCP/IP protocol and for telemetry data transmission with a very low footprint. As protocol of the Internet of Things (IoT), it has been standardized by OASIS (Organization for the Advancement of Structured Information Standards) since 2013. Additional features: Ease of use, efficient use of resources, security mechanisms, support for several cloud systems, session-aware, data-agnostic (i.e. flexible structures allow to transmit multiple types of information)
<b>netFIELD</b>	Technology platform for the industry 4.0 integration of field devices and sensors developed by Hilscher Gesellschaft für Systemautomation mbH
<b>OPC UA</b>	Open Platform Communications Unified Architecture; is a platform-independent standard through which various kinds of systems and devices can communicate by sending Messages between Clients and Servers over various types of networks. It supports robust, secure communication that assures the identity of Clients and Servers and resists attacks.
<b>OPC UA Server for netPROXY</b>	Task-based firmware component integrating the open source project open62541 stack, as well as an additional layer from Hilscher as netPROXY package.
<b>PELV</b>	Protective Extra Low Voltage with safe disconnection
<b>PER</b>	Packet Error Ratio



---

<b>PLC</b>	Programmable Logic Controller: Industrial digital computer for the control of manufacturing processes
<b>QR code</b>	Quick response code according ISO/IEC 18004 standard. A type of two-dimensional barcode that can use up to 4000 alphanumeric characters, often used with smartphone camera.
<b>SELV</b>	Safety Extra Low Voltage
<b>SMI</b>	Standard Master Interface
<b>UUID</b>	Universally Unique Identifier

# Contacts

## HEADQUARTER

### Germany

Hilscher Gesellschaft für  
Systemautomation mbH  
Rheinstraße 15  
65795 Hattersheim  
Phone: +49 (0) 6190 9907-0  
Fax: +49 (0) 6190 9907-50  
E-mail: [info@hilscher.com](mailto:info@hilscher.com)

### Support

Phone: +49 (0) 6190 9907-990  
E-mail: [hotline@hilscher.com](mailto:hotline@hilscher.com)

## SUBSIDIARIES

### China

Hilscher Systemautomation (Shanghai) Co. Ltd.  
200010 Shanghai  
Phone: +86 (0) 21-6355-5161  
E-mail: [info@hilscher.cn](mailto:info@hilscher.cn)

### Support

Phone: +86 (0) 21-6355-5161  
E-mail: [cn.support@hilscher.com](mailto:cn.support@hilscher.com)

### France

Hilscher France S.a.r.l.  
69800 Saint Priest  
Phone: +33 (0) 4 72 37 98 40  
E-mail: [info@hilscher.fr](mailto:info@hilscher.fr)

### Support

Phone: +33 (0) 4 72 37 98 40  
E-mail: [fr.support@hilscher.com](mailto:fr.support@hilscher.com)

### India

Hilscher India Pvt. Ltd.  
Pune, Delhi, Mumbai, Bangalore  
Phone: +91 8888 750 777  
E-mail: [info@hilscher.in](mailto:info@hilscher.in)

### Support

Phone: +91 020-24243777  
E-mail: [info@hilscher.in](mailto:info@hilscher.in)

### Italy

Hilscher Italia S.r.l.  
20090 Vimodrone (MI)  
Phone: +39 02 25007068  
E-mail: [info@hilscher.it](mailto:info@hilscher.it)

### Support

Phone: +39 02 25007068  
E-mail: [it.support@hilscher.com](mailto:it.support@hilscher.com)

### Japan

Hilscher Japan KK  
Tokyo, 160-0022  
Phone: +81 (0) 3-5362-0521  
E-mail: [info@hilscher.jp](mailto:info@hilscher.jp)

### Support

Phone: +81 (0) 3-5362-0521  
E-mail: [jp.support@hilscher.com](mailto:jp.support@hilscher.com)

### Republic of Korea

Hilscher Korea Inc.  
13494, Seongnam, Gyeonggi  
Phone: +82 (0) 31-739-8361  
E-mail: [info@hilscher.kr](mailto:info@hilscher.kr)

### Support

Phone: +82 (0) 31-739-8363  
E-mail: [kr.support@hilscher.com](mailto:kr.support@hilscher.com)

### Austria

Hilscher Austria GmbH  
4020 Linz  
Phone: +43 732 931 675-0  
E-mail: [sales.at@hilscher.com](mailto:sales.at@hilscher.com)

### Support

Phone: +43 732 931 675-0  
E-mail: [at.support@hilscher.com](mailto:at.support@hilscher.com)

### Switzerland

Hilscher Swiss GmbH  
4500 Solothurn  
Phone: +41 (0) 32 623 6633  
E-mail: [info@hilscher.ch](mailto:info@hilscher.ch)

### Support

Phone: +41 (0) 32 623 6633  
E-mail: [support.swiss@hilscher.com](mailto:support.swiss@hilscher.com)

### USA

Hilscher North America, Inc.  
Lisle, IL 60532  
Phone: +1 630-505-5301  
E-mail: [info@hilscher.us](mailto:info@hilscher.us)

### Support

Phone: +1 630-505-5301  
E-mail: [us.support@hilscher.com](mailto:us.support@hilscher.com)