

User manual

CIFX M3042100BM-RE\F

PC cards PCI Express M.2 3042 B-M Real-Time Ethernet



Hilscher Gesellschaft für Systemautomation mbH
www.hilscher.com

DOC210301UM03EN | Revision 3 | English | 2023-06 | Freigegeben | Öffentlich

Table of contents

1	Introduction	5
1.1	About the user manual	5
1.2	List of revisions	5
2	Devices and accessories	6
2.1	Basic card CIFX M3042100BM	7
2.2	Detached network interface AIFX-RE (RJ45)	8
2.3	Detached network interface AIFX-RE\M12	9
2.4	Product software	10
2.5	Revision or version statuses of the hardware and software	11
2.6	Device label with matrix code	12
3	Safety	13
3.1	General note	13
3.2	Intended use	13
3.3	Personnel qualification	13
3.4	Safety messages	14
3.4.1	Hazardous voltage, electric shock	14
3.4.2	Personal injury, device damage due to hot swap/hot plug	14
3.5	Property damage	15
3.5.1	Excessive supply voltage	15
3.5.2	Excessive signaling voltage	15
3.5.3	Electrostatic sensitive devices	15
3.5.4	Power drop during write and delete accesses in the file system	16
3.5.5	Exceeding the maximum number of permitted write and delete accesses	16
3.6	Information and data security	16
4	Installing the hardware	17
4.1	System requirements	17
4.2	Requirements for operation	19
4.3	Overview installation and firmware download	20
4.4	Installation warnings	21
4.5	Install hardware	23
4.6	Loading or updating the firmware and configuration in the device	24
4.7	Troubleshooting information	25
4.8	Uninstall the hardware	27
4.9	Disposal and recycling of waste electronic equipment	28
5	Diagnosis with LEDs	29
5.1	Overview	29
5.2	System LED	30
5.3	CC-Link IE Field Basic Slave	31
5.4	EtherCAT Master (V4)	32
5.5	EtherCAT Slave	34
5.6	EtherNet/IP Scanner	35

5.7	EtherNet/IP Adapter (V3/5)	37
5.8	OpenModbusTCP	39
5.9	POWERLINK Controlled Node.....	40
5.10	PROFINET IO-Controller (V3).....	42
5.11	PROFINET IO-Device	44
5.12	Sercos Master	45
5.13	Sercos Slave	47
5.14	VARAN Client.....	49
6	Connectors	50
6.1	Ethernet RJ45 socket.....	50
6.2	Ethernet M12 socket	51
6.3	Data of the Ethernet connection.....	51
6.4	Usability of hubs and switches	52
6.5	Cable connector Ethernet X700, on CIFX M3042100BM	52
6.6	Cable connector Ethernet X1, AIFX-RE	53
6.7	Cable connector Ethernet X2, AIFX-RE\M12.....	54
6.8	Cable connector LED signals X3, AIFX-RE\M12	55
6.9	PCI Express M.2 bus	56
7	Technical data	58
7.1	PC card CIFX M3042100BM-RE\F	58
7.2	PCI identifier on the PCI Express M.2 bus.....	59
7.3	AIFX-RE	60
7.4	AIFX-RE\M12	61
7.5	Communication protocols.....	62
7.5.1	CC-Link IE Field-Basic-Slave.....	62
7.5.2	EtherCAT Master	63
7.5.3	EtherCAT Slave	64
7.5.4	EtherNet/IP Scanner	66
7.5.5	EtherNet/IP Adapter	67
7.5.6	Open Modbus/TCP	68
7.5.7	POWERLINK Controlled Node	68
7.5.8	PROFINET IO-Controller	69
7.5.9	PROFINET IO-Device.....	71
7.5.10	Sercos Master	73
7.5.11	Sercos Slave	74
7.5.12	VARAN Client	75
8	Dimensions.....	76
8.1	Tolerances of PCB dimensions.....	76
8.2	Dimensions CIFX M3042100BM.....	77
8.3	Dimensions AIFX-RE	78
8.4	Dimensions AIFX-RE\M12	79
9	Appendix.....	80
9.1	FCC compliance.....	80
9.2	References.....	81

9.3	Conventions in this manual	85
9.4	Legal notes.....	86
9.5	Registered trademarks.....	90
9.6	Licenses	90
	Glossary.....	95
	Contacts.....	98

1 Introduction

1.1 About the user manual

This user manual for your PC card CIFX M3042100BM-RE\F Real-Time Ethernet informs you about the topics:

- Hardware description,
- installation of the hardware and
- firmware download.

Further information on how to download the firmware, as well as descriptions about configuration and diagnosis of your device can be found in separate operating instruction manuals.

1.2 List of revisions

Index	Date	Changes
1	2021-07-02	Document created.
2	2023-03-29	UKCA added, in section <i>PC card CIFX M3042100BM-RE\F</i> [▶ page 58], and in sections <i>A\FX-RE</i> [▶ page 60] and <i>A\FX-RE\M12</i> [▶ page 61]. Section <i>Disposal and recycling of waste electronic equipment</i> [▶ page 28] updated. Section <i>Dimensions A\FX-RE</i> [▶ page 78] revised.
3	2023-06-23	Basic card CIFX M3042100BM RE of hardware revision 3 added. Section <i>PCI Express M.2 bus</i> [▶ page 56] updated (Pin 10: BOOT).

Table 1: List of revisions

2 Devices and accessories

The PC card CIFX M3042100BM-RE\F is a communication interface from Hilscher based on the communication controller netX 100 and consists of a basic card that is equipped with a detached network interface.

PC card	Description of the basic card	Detached network interface
CIFX M3042100BM-RE\F, CIFX M3042100BM-RE\F\M12	Communication Interface M.2 3042 Key B+M: CIFX M3042100BM Type (according to the PCI Express M.2 specification): 3042 (=30x42 mm), Keys: B and M PCI Express slot (3.3 V) , for M.2 type 3042-D3, Dual key B-M (Socket 1 Connectivity)	Ethernet RJ45: AIFX-RE, Ethernet M12: AIFX-RE\M12

Table 2: PC card cifX

Product family	Card format and size	netX	Key	Network	Cable
CIFX	M 3042	100	BM	-RE	\F

Table 3: Meaning of the device name

The use refers to Master and Slave systems. Depending on the firmware loaded, the PC cards cifX perform the protocol-specific communication of the selected Real-Time Ethernet system. Data is exchanged between the connected Ethernet devices and the PC or connection device via the Dual-Port Memory.

2.1 Basic card CIFX M3042100BM

In the following illustration with legend you can recognize the device elements significant for installation and operation each by a number.

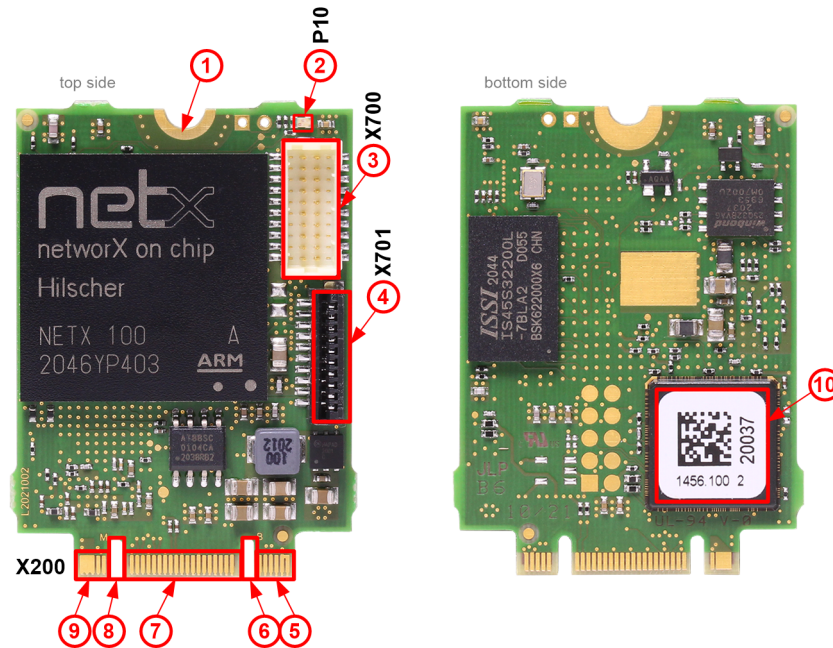

Figure 1: Basic card CIFX M3042100BM

No.	Description
(1)	Hole (with ground contact) for mounting the PC card
(2)	System LED (yellow/green)
(3)	Cable connector Ethernet (X700, 20-pin)
(4)	Cable connector fieldbus (X701, 10-pin)
(5)	PCI Express M.2 bus, pin 1 to pin 11
(6)	PCI Express M.2 bus, pin 12 to pin 19 (key B)
(7)	PCI Express M.2 bus, pin 20 to pin 58
(8)	PCI Express M.2 bus, pin 59 to pin 66 (key M)
(9)	PCI Express M.2 bus, pin 67 to pin 75
(10)	Matrix label

Table 4: Legend for the basic card CIFX M3042100BM

2.2 Detached network interface AIFX-RE (RJ45)

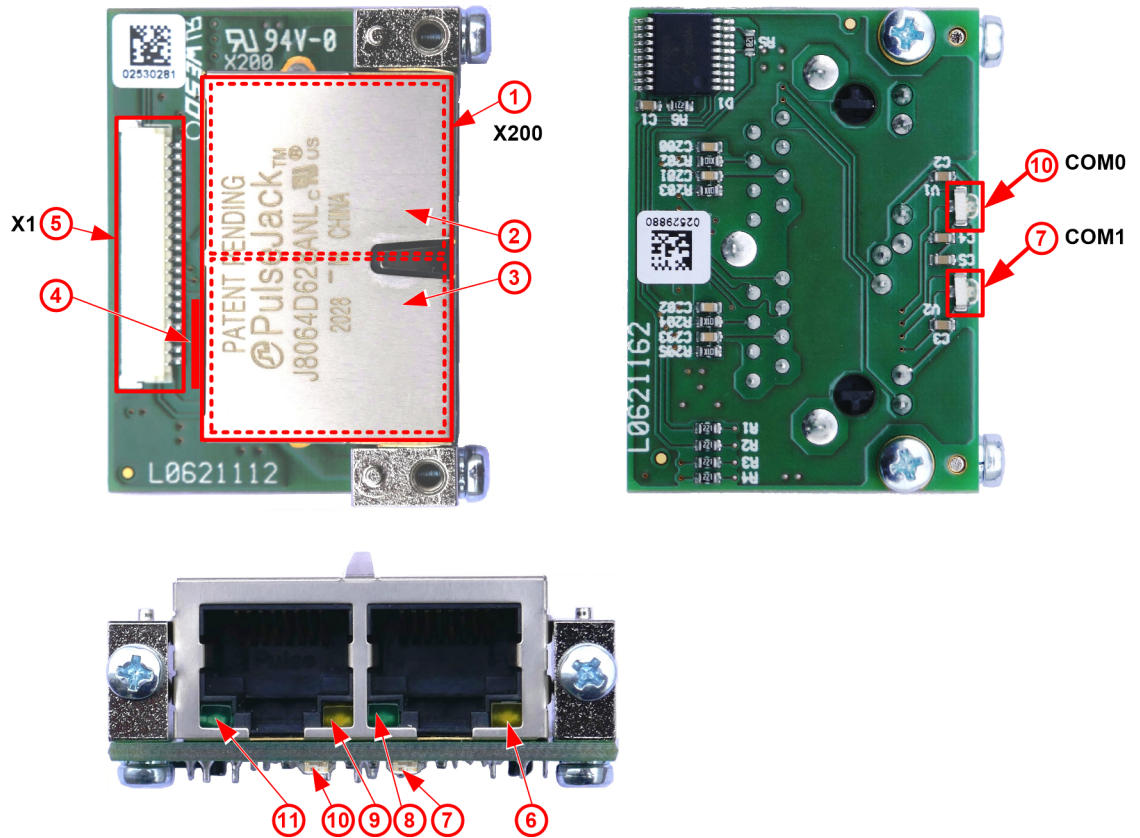

Figure 2: Detached network interface AIFX-RE (RJ45, Revision 3)

No.	Description
(1)	2 x Ethernet RJ45 socket (X200)
(2)	Channel 1 (CH1)
(3)	Channel 0 (CH0)
(4)	Mini matrix label (reverse side X200)
(5)	Cable connector Ethernet (X1, 20-pin)
(6)	Ethernet LED yellow, channel 1 (CH1)
(7)	Communication status LED COM1 (red/green)
(8)	Ethernet LED green, channel 1 (CH1)
(9)	Ethernet LED yellow, channel 0 (CH0)
(10)	Communication status LED COM0 (red/green)
(11)	Ethernet LED green, channel 0 (CH0)

Table 5: Legend for the detached network interface AIFX-RE

2.3 Detached network interface AIFX-REM12

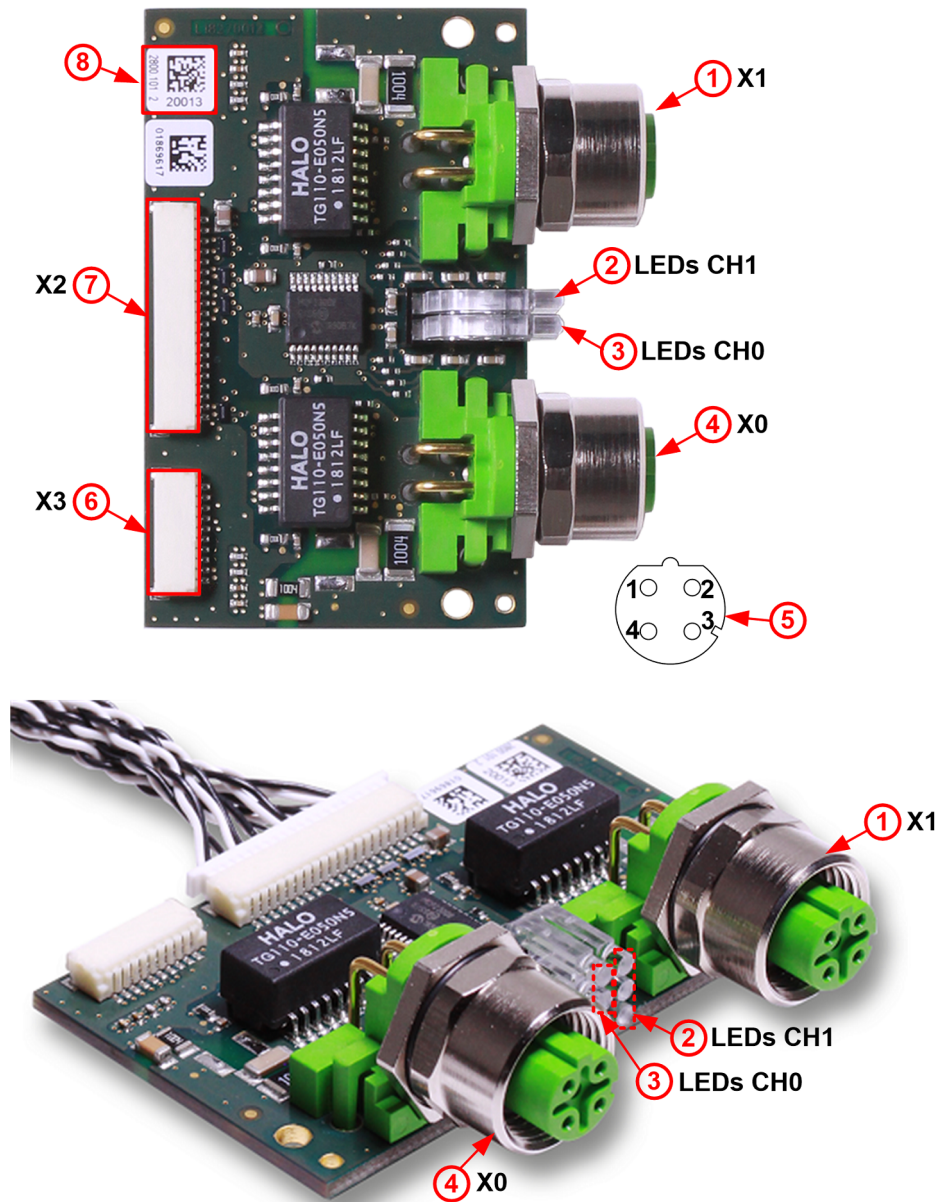

Figure 3: Detached network interface AIFX-REM12 (Revision 2)

No.	Description
(1)	X1, M12 socket channel 1 (CH1)
(2)	Lightpipe, Ethernet LEDs (green/yellow), communication status LED COM1 (red/green) / channel 1 (CH1)
(3)	Lightpipe, Ethernet LEDs (green/yellow), communication status LED COM0 (red/green) / channel 0 (CH0)
(4)	X0, M12 socket channel 0 (CH0)
(5)	Pin assignment M12 socket
(6)	Cable connector (X3, 10-pin)
(7)	Cable connector Ethernet (X2, 20-pin)
(8)	Mini matrix label (P101)

Table 6: Legend for the detached network interface AIFX-REM12

2.4 Product software

All the information and software you need for your product can be downloaded free of charge at the web-link

<https://kb.hilscher.com/display/CARDS/>.

- Select the link for the current release for the Communication Solution DVD.

After the download, you can start commissioning and configuring your device immediately.

- Check our website regularly for software updates for your product.

2.5 Revision or version statuses of the hardware and software

The hardware revisions listed below, as well as the driver, software and firmware versions belong together functionally. If a hardware installation is available, the driver and the firmware must be updated according to these specifications.

Device name	Description	Part no.	Hardware revision
CIFX M3043100BM-RE\F	Communication interface M.2 3042 key B+M Real-Time Ethernet, CIFX M3043100BM basic card and AIFX-RE	1456.101	-
CIFX M3043100BM-RE\F\M12	Communication interface M.2 3042 key B+M Real-Time Ethernet M12, CIFX M3043100BM basic card and AIFX-RE\M12	1456.121	-
CIFX M3043100BM	Basic card	1456.100	3
AIFX-RE	Detached network interface Ethernet RJ45	2800.100	2
AIFX-RE\M12	Detached network interface Ethernet	2800.101	2

Table 7: Hardware revisions

Drivers and software	Name	Version
Device driver	cifX Device Driver	2.5
Configuration software	SYCON.net for netX	1.0500
	cifX TCP/IP Server for SYCON.net	2.6
Developer tools	Driver Toolkit	2.6

Table 8: Versions for drivers and software

Protocol	File name	Firmware version
CC-Link IE Field Basic Slave	C020Y000.nxf	1.2
EtherCAT Master	cifxecm.nxf	4.5
EtherCAT Slave	cifxecs.nxf	4.8
EtherNet/IP Scanner	cifxeim.nxf	2.11
EtherNet/IP Adapter	cifxeis.nxf	3.6
Open Modbus/TCP	cifxomb.nxf	3.1
POWERLINK Controlled Node	C010K000.nxf	3.5
PROFINET IO-Controller	cifxpm.nxf	3.4
PROFINET IO-Device	cifxpns.nxf	4.5
Sercos Master	cifxscm.nxf	2.1
Sercos Slave	cifxscs.nxf	3.5
VARAN Client	cifxvrs.nxf	1.0

Table 9: Firmware version and file names for permitted protocols



Note:

Unless otherwise stated, the firmware version in this manual is the same as the stack version.

2.6 Device label with matrix code

You can identify your device by means of the device label.

**Note:**

The position of the device label on your device is indicated in the device overview.

The device label consists of a matrix code and the information contained therein in plain text.

The 2D code (Data Matrix Code) contains the following information:

- ① Part number: 1234.567
- ② Hardware revision: 1
- ③ Serial number: 20000

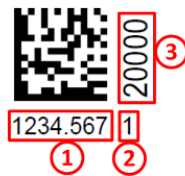

Figure 4: Example 2D label

3 Safety

3.1 General note

The documentation in the form of a user manual, an operating instruction manual or other manual types, as well as the accompanying texts, have been created for the use of the products by qualified personnel. When using the products, all Safety Messages, Integrated Safety Messages, Property Damage Messages and all valid legal regulations must be obeyed. Technical knowledge is presumed. The user has to assure that all legal regulations are obeyed.

3.2 Intended use

Depending on the loaded firmware the PC card CIFX M3042100BM-RE\F (or the device variante CIFX M3042100BM-RE\F\M12) can be used to implement a corresponding Real-Time Ethernet system. Information on the permissible Real-Time Ethernet systems can be found in the section *Revision or version statuses of the hardware and software* [▶ page 11].

3.3 Personnel qualification

The PC card may only be installed, configured, operated or uninstalled by qualified personnel. Job-specific technical skills for people professionally working with electricity must be present concerning the following topics:

- Safety and health at work
- Mounting and connecting of electrical equipment
- Measurement and Analysis of electrical functions and systems
- Evaluation of the safety of electrical systems and equipment
- Installing and configuring IT systems

3.4 Safety messages

3.4.1 Hazardous voltage, electric shock

Danger to life or risk of injury by electric shock may occur if you open the housing of your PC (or connection device) to install your PC card.

- **Hazardous voltages** are present in the PC (or connection device) for mounting. Always read and observe the safety instructions of the PC manufacturer before installation.
- First disconnect the power plug of the PC (or connection device), before opening the housing.
- Make sure that the power supply is off at the PC (or connection device).
- Only then open the housing and install or remove the PC card.

3.4.2 Personal injury, device damage due to hot swap/hot plug

The PC card is not designed or intended for a hot-swap or hot-plug connection. Performing hot-swap or hot-plug may pose a hazard to the PC card, the system platform and the person performing the action.

3.5 Property damage

3.5.1 Excessive supply voltage

The PC card may only be operated with the prescribed supply voltage, which corresponds to the tolerances specified in this manual. The limits of the permitted range must not be exceeded.

Device damage, malfunctions

- If the supply voltage is above the specified upper limit, this can lead to serious damage to the PC card!
- If the supply voltage is below the specified lower limit, malfunctions of the PC card may occur.

3.5.2 Excessive signaling voltage

All I/O signal pins on the PC card tolerate only the specified signal voltage, as specified in this manual.

Device destruction

Operating your PC card at a signal voltage that exceeds the specified signal voltage can cause serious damage to the PC card!

3.5.3 Electrostatic sensitive devices

This equipment is sensitive to electrostatic discharge which cause internal damage and affect normal operation. Therefore adhere to the necessary safety precautions for components that are vulnerable with electrostatic discharge if you install or replace your device. Follow the guidelines listed hereafter when you handle this equipment:

- Touch a grounded object to discharge potential static.
- Wear an approved grounding wriststrap.
- Do not touch connectors or pins on the PC card.
- Do not touch circuit components inside the equipment.
- If available, use a static-safe workstation.
- When not in use, store the equipment in appropriate static-safe packaging.

3.5.4 Power drop during write and delete accesses in the file system

The FAT file system in the netX firmware is subject to certain limitations in its operation. Write and delete accesses in the file system (firmware update, configuration download etc.) can destroy the FAT (File Allocation Table) if the accesses cannot be completed if the power drops. Without a proper FAT, a firmware may not be found and cannot be started.

- Make sure that the power supply of the device does not drop during write and delete accesses in the file system (firmware update, configuration download etc.).

3.5.5 Exceeding the maximum number of permitted write and delete accesses

This device uses a serial flash chip to store remanent data such as firmware storage, configuration storage, etc. This device allows a maximum of 100,000 write/delete accesses that are sufficient for standard operation of the device. However, writing/deleting the chip excessively (e.g. changing the configuration or changing the name of station) leads to the maximum number of permitted write/delete accesses being exceeded and to device damage. For example, if the configuration is changed once an hour, the maximum number is reached after 11.5 years. If the configuration is changed even more frequently, for example once a minute, the maximum number is reached after approx. 69 days.

Avoid exceeding the maximum permitted write/delete accesses by writing too often.

3.6 Information and data security

Take all usual measures for information and data security, in particular, for PC cards with Ethernet technology. Hilscher explicitly points out that a device with access to a public network (Internet) must be installed behind a firewall or only be accessible via a secure connection such as an encrypted VPN connection. Otherwise, the integrity of the device, its data, the application or system section is not safeguarded.

Hilscher cannot assume any warranty or liability for damage due to neglected security measures or incorrect installation.

4 Installing the hardware

4.1 System requirements

In order to install your PC cards cifX, you need a PC or a connection device with a PCI Express M.2 slot (host interface) for mounting the PC card.

Host interface

PC card	Type	Supply voltage (1)	Power consumption (2)	Signal voltage (3)
CIFX M3042100BM-RE\F, CIFX M3042100BM-RE\F\M12	PCI Express slot (3.3 V), for M.2 type 3042-D3, Dual key B-M (Socket 1 Connectivity)	+3.3 VDC \pm 5%	See section <i>PC card CIFX M3042100BM-RE\F</i> [▶ page 58].	PCIe compatible

Table 10: Host interface requirements

Comments:

(1) Required or permissible supply voltage

(2) Typical current consumption at 3.3 V. The typical current consumption depends on the type of PC card. To ensure compatibility between different systems, it is recommended to supply a maximum of 1 A (at +3.3 VDC \pm 5%).

(3) Required or tolerated signal voltage at the I/O signal pins on the PCIe bus of the PC card

Host system

The basic card CIFX M3042100BM uses a netX 100 chip.

Mounting the basic card

In order to mount the basic card, the board on which the PCI Express slot is located must have a corresponding mounting bolt for screwing the basic card on. The dimension for positioning the mounting bolt can be taken from the dimension drawing for the basic card provided in this manual.

Operating system

For SYCON.net for netX: Windows® 10

Component heights

- The component height on the top of the basic card CIFX M3042100BM exceeds the height of 1.5 mm specified by the standard, because the height of the cable connectors (Ethernet X700, or fieldbus X701), including the cable, is approximately 8.5 mm above the circuit board.
- The component height on the bottom of the basic card CIFX M3042100BM complies with the standard specifications.

Panel dimensioning

To mount the detached network interface Ethernet, the required panel cut-outs for the communication status LEDs and the Ethernet sockets, as well as the holes for mounting the AIFX, must be available on the housing of the PC or the connection device.

	AIFX-RE (RJ45)	AIFX-RE\M12
Panel cut-outs The layout for the panel cut-outs must be sufficiently dimensioned for:	<ul style="list-style-type: none"> Two Ethernet RJ45 sockets (for channel 0 and channel 1) The LEDs COM0 and COM1 	<ul style="list-style-type: none"> Two M12 sockets, (default cutout M12) The LEDs COM0 and COM1 The green and yellow Ethernet LEDs
Drill holes	2, at a distance of 37.0 mm	2, at a distance of 55 mm
Further information The dimensions for the required panel cut-outs or the distance of the holes can be found in the dimension drawing for the AIFX.	See section <i>Dimensions AIFX-RE</i> [▶ page 78].	See section <i>Dimensions AIFX-RE\M12</i> [▶ page 79].
See section <i>References</i> [▶ page 81].	Data sheet MOD JACK – MJIM	Data sheet M12 socket

Table 11: Panel cut-outs and holes for mounting AIFX

- **The width of the front panel**

When dimensioning the front panel, note the width of the front panel specified in section *AIFX-RE* [▶ page 60] .

AIFX-RE\M12: Max. permissible current per external LED

When using the Ethernet AIFX-RE\M12 detached network interface with the requirement IP67 and the LED signals are routed via the cable connector LED signals X3 to the mainboard or to a separate detached LED board, the maximum current drawn per LED must not exceed 5 mA.



Note:

The outputs on the cable connector LED signals X3 can drive max. 5 mA. This means that the maximum permissible current per external LED is 5 mA. If this maximum current is not sufficient, an external driver is required previous to the LED.

AIFX-RE\M12: Requirements IP67



Note:

If IP 67 is required: On the Ethernet AIFX-RE\M12 detached network interface, remove the front LED lightpipe and route the LED signals via the cable connector LED signals X3 to the mainboard or a separate detached LED board.

4.2 Requirements for operation

The following described requirements must be fulfilled when operating the PC card.

Requirements	Specification	See section
Hardware installation	Operating the PC card CIFX M3042100BM-RE\F (or CIFX M3042100BM-RE\FM12) requires proper connection of the detached network interface Ethernet AIFX-RE (or AIFX-RE \M12) to the basic card.	-
Communication	<p>For communication of a PC card (slave), a master device is required for the communication system used. For communication of a PC card (master), a slave device is required for the communication system used.</p> <p>To configure the master device, you need a device description file for the slave used with the name for:</p> <ul style="list-style-type: none"> • CC-Link IE Field Basic Slave: 0x0352_CIFX_RE_CCIEBS_1_en.cspp • EtherCAT Slave: Hilscher CIFX_RE ECS V4.6.X.xml, • EtherNet/IP Adapter: HILSCHER CIFX-RE EIS V1.1.EDS, • POWERLINK Controlled Node: 00000044_CIFX_RE_PLS.xdd, • PROFINET IO-Device: GSDML-V2.35-HILSCHER-CIFX_RE PNS-20190621.xml, • and Sercos Slave: SDDML#v3.0#Hilscher#CIFX_RE- FIXCFG_FSPIO#2017-06-28.xml. <p>The settings in the used master must match the settings in the slave.</p>	-
Software installation	<p>cifX Device Driver as the driver for the host interface (latest version of the driver).</p> <p>SYCON.net for netX for configuring and diagnosing netX 100-based devices, as well as software for downloading or updating the firmware and configuration, and for setting the device driver.</p>	<p><i>Revision or version statuses of the hardware and software</i> [▶ page 11] and <i>References</i> [▶ page 81] (Driver and software documentation)</p>
Firmware download	The user must select the firmware using the SYCON.net for netX software and download it to the PC card. The firmware contains a communication protocol.	
Parameter settings	The PC card must be parameterized using the SYCON.net for netX configuration software.	

Table 12: Requirements for operation

4.3 Overview installation and firmware download

Below you find an overview of the steps to install the hardware, driver and firmware for your PC card CIFX M3042100BM-RE\F:

Step	Description	Further information
Downloading installation files	<ul style="list-style-type: none"> Download the installation files from the Hilscher website for: <ul style="list-style-type: none"> - cifX Device Driver (latest version) - SYCON.net for netX Save the installation files to the local hard disk of your PC. 	<i>Revision or version statuses of the hardware and software</i> [▶ page 11]
Install drivers and software	<ul style="list-style-type: none"> Double-click the appropriate installation file to open the startup menu. Start the installation from the home screen and follow the instructions in the installation menu. 	
Install hardware	<ul style="list-style-type: none"> Take the protective measures and safety precautions for the hardware installation. Open the housing of the PC or connection device. Insert the basic card into the PCI Express slot and attach the basic card. Attach the detached network interface to the front panel of the PC. Connect the detached network interface to the basic card. Close the housing of the PC or connection device. 	<i>Install hardware</i> [▶ page 23]
Firmware and configuration download	<ul style="list-style-type: none"> Download the firmware as described in the SYCON.net for netX configuration software operating instruction manual. <p>The PC card cifX is now ready for operation and has yet to be configured.</p> <ul style="list-style-type: none"> Then download the configuration. 	<i>Loading or updating the firmware and configuration in the device</i> [▶ page 24]

Table 13: Overview for installation and firmware download



For detailed descriptions of how to install and operate the software, refer to the relevant operating instruction manual, section *References* [▶ page 81].

4.4 Installation warnings

When installing your device, observe the following warnings on possible personal injury, as well as the warnings on property damage.

WARNING!



Hazardous voltage!
Danger to life, risk of injury by electric shock

Hazardous voltages are present in the PC (or connection device).



- First disconnect the power plug of the PC (or connection device), before you open the housing.
- Make sure that the power supply is off at the PC (or connection device).

CAUTION

Personal injury, device damage due to hot swap/hot plug



The PC card is not designed or intended for a hot-swap or hot-plug connection.

Performing hot-swap or hot-plug may pose a hazard to the PC card, the system platform and the person performing the action.

NOTICE

Electrostatically sensitive devices



To prevent damage to the PC and PC card, make sure the PC card is grounded through the connection plate and PC, and make sure you are grounded when you install or uninstall the PC card.

Installation warnings (USA)

WARNING



Hazardous voltage! Danger to life, risk of injury by electric shock

Hazardous voltages are present in the PC (or connection device).



- First disconnect the power plug of the PC (or connection device), before you open the housing.
- Make sure that the power supply is off at the PC (or connection device).

CAUTION

Personal injury, device damage due to hot swap/hot plug

The PC card is not designed or intended for a hot-swap or hot-plug connection.

Performing hot-swap or hot-plug may pose a hazard to the PC card, the system platform and the person performing the action.

NOTICE

Electrostatically sensitive devices



To prevent damage to the PC and PC card, make sure the PC card is grounded through the connection plate and PC, and make sure you are grounded when you install or uninstall the PC card.

4.5 Install hardware

Install the PC card CIFX M3042100BM-RE\F in your PC or connection device as described below.

1. Preparation

Observe the requirements and prerequisites described in the sections *System requirements* [▶ page 17] and *Requirements for operation* [▶ page 19] .

2. Protective measures and safety precautions

⚠ WARNING Hazardous voltage! Danger to life, risk of injury by electric shock

- Disconnect the power plug of the PC (or connection device).
- Make sure that the power supply is off at the PC (or connection device).

⚠ CAUTION Personal injury, device damage due to hot-plug/hot-swap

- Do not "plug" or "unplug" the PC card during operation.

NOTICE Adhere to the necessary safety precautions for components that are vulnerable with electrostatic discharge.

- Make sure that the device is grounded via the endplate and the PC, and make sure that you are discharged when you install/uninstall the device.

NOTICE Device damage due to over torquing of the mounting screw

Do not over torque the screw used to mount the basic card to the board to prevent damage to the printed circuit board.

3. Installation

- Open the housing of the PC or connection device.
- Insert the basic card into the PCI Express slot.
- Screw the basic card onto the board. To do this, use the crescent-shaped hole on the top edge of the basic card. The ground contact via the screw head must be ensured.
- First, attach the detached network interface Ethernet AIFX-RE (or AIFX-RE\M12) to the PC or connection device housing panel.
- Then connect the detached network interface Ethernet AIFX-RE (or AIFX-RE\M12) to the basic card.

- To do this, first plug the cable into the Ethernet X1 cable connector on the AIFX-RE (or the Ethernet X2 cable connector on the AIFX-RE\M12).

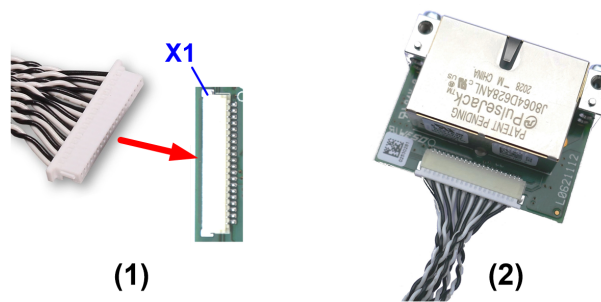

Figure 5: Connecting cable to the detached network interface Ethernet AIFX-RE

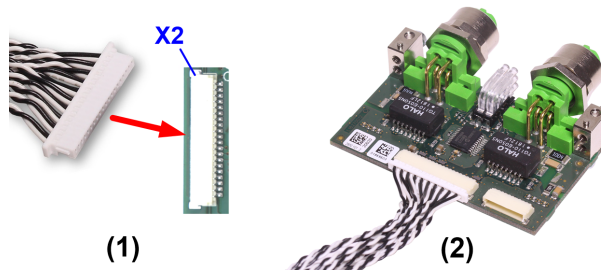

Figure 6: Connecting cable to the detached network interface Ethernet AIFX-RE\M12

- Then plug the cable into the cable connector Ethernet X700 on the basic card.

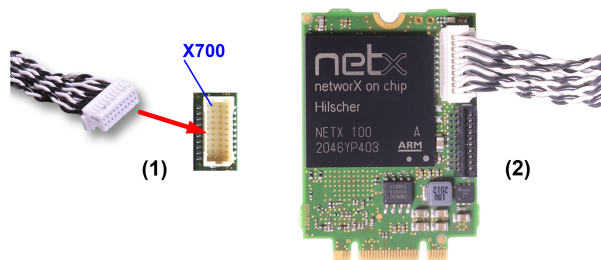

Figure 7: Connecting cable to the basic card, example CIFX M3042100BM

- Close the housing of the PC or connection device again.

4.6 Loading or updating the firmware and configuration in the device

- Download the firmware from the Hilscher website and save the firmware to your PC's local hard disk.
- If necessary, transfer the configuration to the PC. Create the configuration using an appropriate configuration software.
- Use **SYCON.net for netX** to load the firmware and configuration into the device, or update the firmware and configuration in your device.
- To download the firmware and configuration to your device, or to update, follow the instructions in the "SYCON.net for netX" configuration software operating instruction manual.



For the "SYCON.net for netX" configuration software operating instruction manual, see section *References* [▶ page 81].

4.7 Troubleshooting information

In case of an error or a malfunction of your PC card cifX, observe the following information for problem solving:

General

- Verify that the PC card is operating according to the information provided in this user manual.

SYS and COM status LEDs

You can troubleshoot the system by checking the behavior of the LEDs.

- The SYS LED (yellow/green) on the device indicates the general device status and can be switched on, off or blinks.
- The LEDs COM0 (red/green) and COM1 (red/green) at the detached network interface Ethernet indicate the status of the device communication and may be switched on or off permanently or in phases, flash or they blink cyclically or acyclically.

If the SYS LED lights static green and the COM0 LED lights static green or "off" (or the COM LEDs behave as shown in the table below), the PC card cifX is in the "in operation" state. The master device is in the data exchange with the connected slave devices. The slave device is in the state of cyclic communication with the connected master device. The communication between the master device and the slave device runs without interference.

LED	CC-Link IE Field Basic Slave	Ether CAT	EtherNet/IP	Open Modbus/TCP	POWER -LINK	PROFI-NET IO	Sercos Master	Sercos Slave
COM 0	RUN ● (green on)	RUN ● (green on)	MS ● (green on)	RUN ● (green on)	BS ● (green on)	SF ● (off)	STA ● (green on)	S ● (green on)
COM 1	ERR ● (off)	ERR ● (off)	NS ● (green on)	ERR (off)	BE ● (off)	BF ● (off)	ERR ● (off)	-

Table 14: Behavior of the communication status LEDs in the "in operation" status



Note:

The communication status and Ethernet LEDs on the device are determined by the loaded protocol firmware.

Ethernet LEDs

- Check the status of the Ethernet LEDs (LINK or L/A) to see if there is a connection to the Ethernet.

Cable

- Check that the pin assignment of the cable used to connect the PC card (master) to the slave device or the PC card (slave) to the master device is correct.



For detailed descriptions of the behavior of the LEDs, refer to the chapter on the LEDs in this manual. For information about the device diagnostics and their functions, see the operating instruction manual of the configuration software for your device.

4.8 Uninstall the hardware

Uninstall the PC card CIFX M3042100-RE\F from the PC or connection device as described below.

1. Protective measures and safety precautions

⚠ WARNING Hazardous voltage! Danger to life, risk of injury by electric shock

- Disconnect the power plug of the PC (or connection device).
- Make sure that the power supply is off at the PC (or connection device).

⚠ CAUTION Personal injury, device damage due to hot-plug/hot-swap

- Do not "plug" or "unplug" the PC card during operation.

NOTICE Adhere to the necessary safety precautions for components that are vulnerable with electrostatic discharge.

- Make sure that the device is grounded via the endplate and the PC, and make sure that you are discharged when you install/uninstall the device.

2. Uninstallation

- Open the housing of the PC or connection device.
- Remove the detached network interface Ethernet from the basic card.
- To do this, pull the cable out of the cable connector Ethernet X700 on the basic card and out of the cable connector Ethernet X1 on the AIFX-RE.
- Loosen the screw that secures the basic card to the board.
- Remove the basic card from the PCI Express slot.
- Remove the detached network interface from the housing cover of the PC or connection device.
- Close the housing of the PC or connection device again.

4.9 Disposal and recycling of waste electronic equipment

Waste electronic equipment must be disposed of properly after the end of use.



Waste electronic equipment

This product must not be disposed of with household waste.

Dispose of this product in accordance with local regulations in your country.

When disposing of the product, observe the following:

- Observe national and local regulations for the disposal of waste electronic equipment and packaging.
- Delete personal data stored in the waste electronic device.
- Dispose of this product in an environmentally friendly manner at a local collection point for waste electronic equipment.
- Dispose of packaging in such a way that a high level of recycling is possible.

Alternatively, you can return our products to us for disposal. The prerequisite is that no additional foreign substances are contained. Before returning, please contact us via the Return Merchandise Authorization (RMA) form on www.hilscher.com.

In Europe, the directive 2012/19/EU waste electrical and electronic equipment applies. Different policies and laws may apply nationally.

5 Diagnosis with LEDs

5.1 Overview



Note:

The communication status and Ethernet LEDs on the device are determined by the loaded protocol firmware.

Specification in the device drawing	CC-Link IE Field Basic Slave	Ether CAT Master	Ether CAT Slave	Ether Net/IP	Open Modbus/TCP	POWER-LINK	PROFI-NET IO	Sercos Master	Sercos Slave
SYS System status ● Yellow/ green	SYS	SYS	SYS	SYS	SYS	SYS	SYS	SYS	SYS
COM 0 Communication status	RUN ● Green	RUN ● Green	RUN ● Green	MS ● Red/ green	RUN ● Green	BS ● Green	SF ● Red	STA ● Green	S ● Red/ green/ orange
COM 1 Communication status	ERR ● Red	ERR ● Red	ERR ● Red	NS ● Red/ green	ERR ● Red	BE ● Red	BF ● Red	ERR ● Red	-
Ether-net CH0	● Green	L/A	LINK	L/A IN	LINK	LINK	L/A	LINK	L/A
	● Yellow	-	ACT	-	ACT	ACT	-	RX/TX	-
Ether-net CH1	● Green	L/A	-	L/A OUT	LINK	LINK	L/A	LINK	L/A
	● Yellow	-	-	-	ACT	ACT	-	RX/TX	-

Table 15: LEDs Real-Time Ethernet systems (duo LEDs and Ethernet LEDs)

Category	LED	Name	Category	LED	Name
System status	SYS	System status	Ethernet	LINK, L	Link
Communication status	COM	Communication status		ACT, A	Activity
	RUN	Run		L/A	Link/Activity
	ERR	Error		L/A IN	Link/Activity Input
	STA	Status		L/A OUT	Link/Activity Output
	MS	Module status		RX/TX	Receive/Transmit
	NS	Network status			
	BS	Bus status			
	BE	Bus error			
	SF	System failure			
	BF	Bus failure			
	S	Status / error			

Table 16: LED designations

5.2 System LED

The system status LED **SYS** can assume the states described below.





LED	Color	State	Description
SYS	Duo LED yellow/green		
	 (green)	On	Operating system is running.
	 (green/ yellow)	Blinking	Second stage bootloader is waiting for firmware.
	 (yellow)	On	Bootloader netX (= romloader) is waiting for second stage bootloader.
	 (off)	Off	Power supply for the device is missing or hardware defect.

Table 17: States of the SYS LED, netX 10/50/51/52/100/500-based devices

5.3 CC-Link IE Field Basic Slave

For the CC-Link IE Field Basic slave protocol, the communication LEDs **RUN** and **ERR** as well as the Ethernet LED **L/A** can assume the states described below. This description is valid from stack version V1.1.









LED	Color	State	Description
RUN Position in the device overview: (10)	Duo LED red/green		
	 (green)	On	Station in operation and cyclic transmission in progress.
	 (green)	Blinking (2.5 Hz)	Station in operation and cyclic transmission stopped.
	(green)	Flickering (10 Hz)	Station not configured.
ERR Position in the device overview: (7)	 (red)	Off	Station is disconnected.
	 (red)	On	Communication error.
	 (red)	Triple Flash	DPM watchdog has expired.
L/A Ch0: (11) , Ch1: (8)	LED green		
	 (green)	Off	The station has no link to the Ethernet.
	 (grün)	Flickering (load dependent)	Activity: The station is linked to the Ethernet and sends/receives Ethernet frames.
	 (green)	On	Link: The station is linked to the Ethernet, but does not send/receive Ethernet frames.
Ch0: (9) , Ch1: (6)	LED yellow		
	 (off)	Off	This LED is not used.

Table 18: LED states for the CC-Link IE Field Basic slave

LED state	Definition
Triple Flash	The LED shows a sequence of three short flashes (each 200 ms), separated by a short "Off" phase (200 ms). The sequence is finished by a long "Off" phase (1,000 ms).
Blinking (2.5 Hz)	The LED turns on and off with a frequency of 2.5 Hz: "On" for 200 ms, followed by "Off" for 200 ms.
Flickering (10 Hz)	The LED turns on and off with a frequency of 10 Hz: "On" for 50 ms, followed by "Off" for 50 ms.
Flickering (load dependent)	The LED turns on and off with a frequency of 10 Hz to indicate high Ethernet activity: "On" for 50 ms followed by "Off" for 50 ms. The LED turns on and off at irregular intervals to indicate low Ethernet activity.

Table 19: LED state definitions for the CC-Link IE Field Basic slave protocol

5.4 EtherCAT Master (V4)

For the EtherCATMaster protocol, the communication LEDs **RUN** and **ERR** as well as the Ethernet LEDs **LINK** and **ACT** can assume the states described below. This description is valid from stack version V4.0.

Communication status EtherCAT Master (V4)















LED	Color	State	Description
RUN Position in the device overview: (10)	Duo LED red/green		
	 (off)	Off	INIT: The device is in INIT state.
	 (green)	Blinking (2.5 Hz)	PRE-OPERATIONAL: The device is in PRE-OPERATIONAL state.
	 (green)	Flickering (10 Hz)	The device is not configured.
	 (green)	Single flash	SAFE-OPERATIONAL: The device is in SAFE-OPERATIONAL state.
	 (green)	On	OPERATIONAL: The device is in the OPERATIONAL state.
ERR Position in the device overview: (7)	Duo LED red/green		
	 (off)	Off	Master has no errors
	 (red)	Single flash	Bus Sync error threshold
	 (red)	Double flash	Internal Stop of the bus cycle
	 (red)	Triple flash	DPM watchdog has expired.
	 (red)	Quadruple flash	No Master license present in the device.
	 (red)	Blinking (2.5 Hz)	Error in the configuration database.
	 (red)	Single flickering	Channel Init was executed at the Master. Transient state that may not be visible.
	 (red)	Double flickering	Slave is missing Unconfigured slave No matching mandatory slave list No bus connected
 (red)	Flickering (10 Hz)	Boot-up was stopped due to an error.	

Table 20: Communication status EtherCAT Master (V4)

LED state	Definition
Single flash	The LED shows one short flash (200 ms) followed by a long "Off" phase (1,000 ms).
Double flash	The LED shows a sequence of two short flashes (each 200 ms), separated by a short "Off" phase (200 ms). The sequence is finished by a long "Off" phase (1,000 ms).
Triple flash	The LED shows a sequence of three short flashes (each 200 ms), separated by a short "Off" phase (200 ms). The sequence is finished by a long "Off" phase (1,000 ms).
Quadruple flash	The LED shows a sequence of four short flashes (each 200 ms), separated by a short "Off" phase (200 ms). The sequence is finished by a long "Off" phase (1,000 ms).
Blinking (2.5 Hz)	The LED turns on and off with a frequency of 2.5 Hz: "On" for 200 ms, followed by "Off" for 200 ms.
Single flickering	The LED is switched on and off once: "On" for 50 ms, followed by "Off" for 500 ms.
Double flickering	The LED is switched on and off and on once: "On" / "Off" / "On" each for approximately 50 ms, followed by "Off" for 500 ms.

LED state	Definition
Flickering (10 Hz)	The LED turns on and off with a frequency of 10 Hz: "On" for 50 ms, followed by "Off" for 50 ms.

Table 21: Definition of the LED states communication status

Ethernet status EtherCAT Master (V4)





LED	Color	State	Description
LINK Ch0: (11)	LED green		
	 (green)	On	Link: The device is linked to the Ethernet, but does not send/receive Ethernet frames.
	 (green)	Flickering (load dependent)	Activity: The device is linked to the Ethernet and sends/receives Ethernet frames.
	 (off)	Off	The device has no link to the Ethernet.
ACT Ch0: (9)	LED yellow		
	 (off)	Off	This LED is not used.

Table 22: Ethernet status EtherCAT Master (V4)

LED state	Definition
Flickering (load dependent)	The LED turns on and off with a frequency of approximately 10 Hz to indicate high Ethernet activity: "On" for approximately 50 ms, followed by "Off" for 50 ms. The LED turns on and off in irregular intervals to indicate low Ethernet activity.

Table 23: Definition of the LED state Ethernet status

5.5 EtherCAT Slave

For the EtherCAT Slave protocol, the communication LEDs **RUN** and **ERR** as well as the Ethernet LED **L/A IN** or **L/A OUT** can assume the states described below. This description is valid from stack version V2.5 (V2).

Communication status EtherCAT Slave

LED	Color	State	Description
RUN Position in the device overview: (10)	Duo LED red/green		
	● (off)	Off	INIT: The device is in INIT state.
	☀ (green)	Blinking (2.5 Hz)	PRE-OPERATIONAL: The device is in PRE-OPERATIONAL state.
	☀ (green)	Single flash	SAFE-OPERATIONAL: The device is in SAFE-OPERATIONAL state.
	● (green)	On	OPERATIONAL: The device is in the OPERATIONAL state.
ERR Position in the device overview: (7)	Duo LED red/green		
	● (off)	Off	No error: The EtherCAT communication of the device is in working condition.
	☀ (red)	Blinking (2.5 Hz)	Invalid configuration: General Configuration Error Possible reason: State change commanded by master is impossible due to register or object settings.
	☀ (red)	Single flash	Local error: Slave device application has changed the EtherCAT state autonomously. Possible reason 1: A host watchdog timeout has occurred. Possible reason 2: Synchronization Error, device enters Safe-Operational automatically.
	☀ (red)	Double flash	Application watchdog timeout: An application watchdog timeout has occurred. Possible reason: Sync Manager Watchdog timeout.

Table 24: Communication status EtherCAT Slave

LED state	Definition
Blinking (2.5 Hz)	The LED turns on and off with a frequency of 2.5 Hz: "On" for 200 ms, followed by "Off" for 200 ms.
Single flash	The LED shows one short flash (200 ms) followed by a long "Off" phase (1,000 ms).
Double flash	The LED shows a sequence of two short flashes (each 200 ms), separated by a short "Off" phase (200 ms). The sequence is finished by a long "Off" phase (1,000 ms).

Table 25: Definition LED states communication status

Ethernet status EtherCAT Slave

LED	Color	State	Description
L/A IN, L/A OUT Ch0: (11), Ch1: (8)	LED green		
	● (green)	On	Link: The device is linked to the Ethernet, but does not send/receive Ethernet frames.
	☀ (green)	Flickering (load dependent)	Activity: The device is linked to the Ethernet and sends/receives Ethernet frames.
	● (off)	Off	The device has no link to the Ethernet.
Ch0: (9), Ch1: (6)	LED yellow		
	● (off)	Off	This LED is not used.

Table 26: Ethernet status EtherCAT Slave

LED state	Definition
Flickering (load dependent)	The LED turns on and off with a frequency of approximately 10 Hz to indicate high Ethernet activity: "On" for approximately 50 ms, followed by "Off" for 50 ms. The LED turns on and off in irregular intervals to indicate low Ethernet activity.

Table 27: Definition LED states Ethernet status

5.6 EtherNet/IP Scanner

For the EtherNet/IP Scanner protocol, the communication LEDs **MS** and **NS** as well as the Ethernet LEDs **LINK** and **ACT** can assume the states described below. This description is valid from stack version V2.6.

Communication status EtherNet/IP Scanner













LED	Color	State	Description
MS (module status) Position in the device overview: (10)	Duo LED red/green		
	 (green)	On	Device operational: The device is operating correctly.
	 (green)	Flashing (1 Hz)	Standby: The device has not been configured.
	 (green/red/green)	Flashing green/red/green	Self-test: The device performs a self-test after power-on. The following sequence is displayed during the self-test: <ul style="list-style-type: none"> • NS-LED off. • MS LED turns green for approximately 250 ms, turns red for approximately 250 ms, and again turns green (and holds that state until the power-up test has completed). • NS LED turns green for approximately 250 ms, turns red for approximately 250 ms, and then turns off (and holds that state until the power-up test has completed).
	 (red)	Flashing (1 Hz)	Major recoverable fault: The device has detected a major recoverable fault. E.g., an incorrect or inconsistent configuration can be considered a major recoverable fault.
	 (red)	On	Major unrecoverable fault: The device has detected a major unrecoverable fault.
	 (off)	(Off)	No power: The device is powered off.
NS (Network status) Position in the device overview: (7)	Duo LED red/green		
	 (green)	On	Connected: An IP address is configured, at least one CIP connection (any transport class) is established, and an Exclusive Owner connection has not timed out.
	 (green)	Flashing (1 Hz)	No connections: An IP address is configured, but no CIP connections are established, and an Exclusive Owner connection has not timed out.
	 (green/red/off)	Flashing green/red/off	Self-test: The device performs a self-test after power-on. Refer to the description of the MS LED in the self-test status.
	 (red)	Flashing (1 Hz)	Connection timeout: An IP address is configured, and an Exclusive Owner connection for which this device is the target has timed out. The NS LED returns to steady green only when all timed out Exclusive Owner connections are reestablished.
	 (red)	On	Duplicate IP: The device has detected that its IP address is already in use.
	 (off)	Off	Not powered, no IP address: The device does not have an IP address (or is powered off).

Table 28: Communication status EtherNet/IP Scanner

LED state	Definition
Flashing (1 Hz)	The LED turns on and off with a frequency of 1 Hz: "On" for 500 ms, followed by "Off" for 500 ms.
Flashing fast green/red/green	The MS LED or NS LED turns on green "On" for 250 ms, then red "On" for 250 ms, then green "On" (until the test is completed).

Table 29: Definition of the LED states communication status

Ethernet status EtherNet/IP Scanner





LED	Color	State	Description
LINK Ch0: (11) , Ch1: (8)	LED green		
	 (green)	On	The device is linked to the Ethernet.
	 (off)	Off	The device has no link to the Ethernet.
ACT Ch0: (9) , Ch1: (6)	LED yellow		
	 (yellow)	Flickering (load dependent)	The device sends/receives Ethernet frames.
	 (off)	Off	The device does not send/receive Ethernet frames.

Table 30: Ethernet status EtherNet/IP Scanner

LED state	Definition
Flickering (load dependent)	The LED turns on and off with a frequency of approximately 10 Hz to indicate high Ethernet activity: "On" for approximately 50 ms, followed by "Off" for 50 ms. The LED turns on and off in irregular intervals to indicate low Ethernet activity

Table 31: Definition of the LED state Ethernet status

5.7 EtherNet/IP Adapter (V3/5)

For the EtherNet/IP Adapter protocol, the communication LEDs **MS** and **NS** as well as the Ethernet LEDs **LINK** and **ACT** can assume the states described below. This description is valid from stack version V3.4 or from V5.1.

Communication status EtherNet/IP Adapter















LED	Color	State	Description
MS (module status) Position in the device overview: (10)	Duo LED red/green		
	 (green)	On	Device operational: The device is operating correctly.
	 (green)	Flashing (1 Hz)	Standby: The device has not been configured.
	 (green/red/green)	Flashing fast green/red/green	Self-test: The device performs a self-test after power-on. The following sequence is displayed during the self-test: <ul style="list-style-type: none"> • NS-LED off. • MS LED turns green for approximately 250 ms, turns red for approximately 250 ms, and again turns green (and holds that state until the power-up test has completed). • NS LED turns green for approximately 250 ms, turns red for approximately 250 ms, and then turns off (and holds that state until the power-up test has completed).
	 (red/green/off)	Flashing sequence red/green/off	Flashing sequence: The flashing sequence is used to visually identify the device. The scanner can start the flashing sequence in Identity object 1 of the device. The MS LED and NS LED perform the flashing sequence simultaneously.
	 (red)	Flashing (1 Hz)	Major recoverable fault: The device has detected a major recoverable fault. E.g., an incorrect or inconsistent configuration can be considered a major recoverable fault.
	 (red)	On	Major unrecoverable fault: The device has detected a major unrecoverable fault.
 (off)	Off	No power: The device is powered off.	
NS (Network status) Position in the device overview: (7)	Duo LED red/green		
	 (green)	On	Connected: An IP address is configured, at least one CIP connection (any transport class) is established, and an Exclusive Owner connection has not timed out.
	 (green)	Flashing (1 Hz)	No connections: An IP address is configured, but no CIP connections are established, and an Exclusive Owner connection has not timed out.
	 (green/red/green)	Flashing fast green/red/green	Self-test: The device performs a self-test after power-on. Refer to the description of the MS LED in the self-test status.
	 (red/green/off)	Flashing sequence red/green/off	Flashing sequence: The flashing sequence is used to visually identify the device. The scanner can start the flashing sequence in Identity object 1 of the device. The MS LED and NS LED perform the flashing sequence simultaneously.
	 (red)	Flashing (1 Hz)	Connection timeout: An IP address is configured, and an Exclusive Owner connection for which this device is the target has timed out. The NS LED returns to steady green only when all timed out Exclusive Owner connections are reestablished.
	 (red)	On	Duplicate IP: The device has detected that its IP address is already in use.
 (off)	Off	Not powered, no IP address: The device does not have an IP address (or is powered off).	

Table 32: Communication status EtherNet/IP Adapter

LED state	Definition
Flashing (1 Hz)	The LED turns on and off with a frequency of 1 Hz: "On" for 500 ms, followed by "Off" for 500 ms.
Flashing fast green/red/green	The MS LED or NS LED turns on green "On" for 250 ms, then red "On" for 250 ms, then green "On" (until the test is completed).
Flashing sequence red/green/off	The MS LED and NS LED each turn red "On" for 500 ms, then green "On" for 500 ms, then "Off" for 500 ms. This flashing sequence is repeated at least 6 times.

Table 33: Definition LED states communication status

Ethernet status EtherNet/IP Adapter





LED	Color	State	Description
LINK Ch0: (11) , Ch1: (8)	LED green		
	 (green)	On	The device is linked to the Ethernet.
	 (off)	Off	The device has no link to the Ethernet.
ACT Ch0: (9) , Ch1: (6)	LED yellow		
	 (yellow)	Flickering (load dependent)	The device sends/receives Ethernet frames.
	 (off)	Off	The device does not send/receive Ethernet frames.

Table 34: Ethernet status EtherNet/IP Adapter

LED state	Definition
Flickering (load dependent)	The LED turns on and off with a frequency of approximately 10 Hz to indicate high Ethernet activity: "On" for approximately 50 ms, followed by "Off" for 50 ms. The LED turns on and off in irregular intervals to indicate low Ethernet activity

Table 35: Definition LED states Ethernet status

5.8 OpenModbusTCP

For the OpenModbusTCP protocol, the communication LEDs **RUN** and **ERR** as well as the Ethernet LEDs **LINK** and **ACT** can assume the states described below. This description is valid from stack version V0.9.

Communication status OpenModbusTCP







LED	Color	State	Description
RUN Position in the device overview: (10)	Duo LED red/green		
	 (green)	On	Connected: OMB task has communication. At least one TCP connection is established.
	 (green)	Flashing (1 Hz)	Ready, not configured yet: OMB task is ready and not yet configured.
	 (green)	Flashing (5 Hz)	Waiting for Communication: OMB task is configured.
	 (off)	Off	Not Ready: OMB task is not ready.
ERR Position in the device overview: (7)	Duo LED red/green		
	 (off)	Off	No communication error
	 (red)	Flashing (2 Hz, 25% on)	System error
	 (red)	On	Communication error active

Table 36: Communication status OpenModbusTCP

LED state	Definition
Flashing (1 Hz)	The LED turns on and off with a frequency of 1 Hz: "On" for 500 ms, followed by "Off" for 500 ms.
Flashing (5 Hz)	The LED turns on and off with a frequency of 5 Hz: "On" for 100 ms, followed by "Off" for 100 ms.
Flashing (2 Hz, 25% on)	The LED turns on and off with a frequency of 2 Hz: "On" for 125 ms, followed by "Off" for 375 ms.

Table 37: Definition LED states communication status

Ethernet status OpenModbusTCP





LED	Color	State	Description
LINK Ch0: (11) , Ch1: (8)	LED green		
	 (green)	On	The device is linked to the Ethernet.
	 (off)	Off	The device has no link to the Ethernet.
ACT Ch0: (9) , Ch1: (6)	LED yellow		
	 (yellow)	Flickering (load dependent)	The device sends/receives Ethernet frames.
	 (off)	Off	The device does not send/receive Ethernet frames.

Table 38: Ethernet status OpenModbusTCP

LED state	Definition
Flickering (load dependent)	The LED turns on and off with a frequency of approximately 10 Hz to indicate high Ethernet activity: "On" for approximately 50 ms, followed by "Off" for 50 ms. The LED turns on and off in irregular intervals to indicate low Ethernet activity.

Table 39: Definition LED states Ethernet status

5.9 POWERLINK Controlled Node

For the POWERLINK Controlled Node protocol, the communication LEDs **BS** (Busstatus) and **BE** (Bus-Error) as well as the Ethernet LED **L/A** can assume the states described below. This description is valid from stack version V2.1 respectively from stack version V3.0.

Communication status POWERLINK Controlled Node

LED	Color	State	Description
BS (Bus status) Position in the device overview: (10)	Duo LED red/green		
	● (green)	On	Slave is in state , Operational ' state.
	☀ (green)	Triple flash	Slave is in , ReadyToOperate ' state.
	☀ (green)	Double flash	Slave is in , Pre-Operational 2 ' state.
	☀ (green)	Single flash	Slave is in , Pre-Operational 1 ' state.
	☀ (green)	Flickering (10 Hz)	Slave is in , Basic Ethernet ' state.
	☀ (green)	Blinking (2.5 Hz)	Slave is in , Stopped ' state.
	● (off)	Off	Slave initializing
BE (Bus error) Position in the device overview: (7)	Duo LED red/green		
	● (off)	Off	Slave has no error
	● (red)	On	Slave has detected an error

Table 40: Communication status POWERLINK Controlled Node

LED state	Definition
Triple flash	The LED shows a sequence of three short flashes (each 200 ms), separated by a short "Off" phase (200 ms). The sequence is finished by a long "Off" phase (1,000 ms).
Double flash	The LED shows a sequence of two short flashes (each 200 ms), separated by a short "Off" phase (200 ms). The sequence is finished by a long "Off" phase (1,000 ms).
Single flash	The LED shows one short flash (200 ms) followed by a long "Off" phase (1,000 ms).
Flickering (10 Hz)	The LED turns on and off with a frequency of 10 Hz: "On" for 50 ms, followed by "Off" for 50 ms. The red LED and the green LED are switched on alternately.
Blinking (2.5 Hz)	The LED turns on and off with a frequency of 2.5 Hz: "On" for 200 ms, followed by "Off" for 200 ms. The red LED and the green LED are switched on alternately.

Table 41: Definition of LED states communication status

Ethernet status POWERLINK Controlled Node





LED	Color	State	Description
L/A Ch0: (11), Ch1: (8)	LED green		
	 (green)	On	Link: The device is linked to the Ethernet, but does not send/receive Ethernet frames.
	 (green)	Flickering (load dependent)	Activity: The device is linked to the Ethernet and sends/receives Ethernet frames.
	 (off)	Off	The device has no link to the Ethernet.
Ch0: (9), Ch1: (6)	LED yellow		
	 (off)	Off	This LED is not used.

Table 42: Ethernet status POWERLINK Controlled Node

LED state	Definition
Flickering (load dependent)	The LED turns on and off with a frequency of approximately 10 Hz to indicate high Ethernet activity: "On" for approximately 50 ms, followed by "Off" for 50 ms. The LED turns on and off in irregular intervals to indicate low Ethernet activity.

Table 43: Definition of LED state Ethernet status

5.10 PROFINET IO-Controller (V3)

For the PROFINET IO Controller protocol, the system status LED **SYS**, the communication LEDs **SF** (system failure) and **BF** (bus failure), as well as the Ethernet LEDs **LINK** and **RX/TX** can assume the states described below. This description is valid from stack version V3.0.

System and communication status PROFINET IO-Controller

SYS	SF	BF	Description
System status	System Failure Position in the device overview: (10)	Bus Failure Position in the device overview: (7)	LED name
Yellow/green	Red/green	Red/green	Colors of the Duo LEDs SYS, SF or BF
Firmware and Configuration			
● Off	● Off	● Off	Power supply for the device is missing or hardware defect.
● On, yellow	● Off	● Off	No second stage bootloader found in Flash memory.
☀️ Flashing, green/ yellow, cyclic	● Off	● Off	No firmware file found in Flash file system.
● On, green	● On, red	● Off	PROFINET IO Controller is not configured.
● On, green	● Off	● On, red	No Ethernet port has a link. E. g., no cable connected to any of the Ethernet ports.
● On, green	● Off	☀️ Flashing, red, 2 Hz	PROFINET IO Controller is not online (Bus is switched to Off).
PROFINET communication			
● On, green	● Off or ● On, red	☀️ Flashing, red, 1Hz	Not all configured devices are in data exchange.
● On, green	● On, red	-	One IO Device connected to the PROFINET IO Controller reports a problem.
● On, green	● Off	● Off	All devices are in data exchange and no problem has been reported by any device.
PROFINET IO Controller operation			
● On, green	☀️ Flashing, red, 1 Hz, 3 s	● Off	A PROFINET DCP Set Signal has been received.
● On, green	☀️ Flashing, red, 2 Hz	☀️ Flashing, red, 2 Hz	The PROFINET IO Controller has detected an address conflict. Another device in the network is using the same Name of Station or IP address as the PROFINET IO Controller. Or watchdog error
● On, green	● On, red	● On, red	No valid Master license

Table 44: System and communication status PROFINET IO-Controller

LED state	Definition
Flashing (1 Hz, 3 s)	The LED turns on and off for 3 seconds with a frequency of 1 Hz: "On" for 500 ms, followed by "Off" for 500 ms.
Flashing (1 Hz)	The LED turns on and off with a frequency of 1 Hz: "On" for 500 ms, followed by "Off" for 500 ms.
Flashing (2 Hz)	The LED turns on and off with a frequency of 2 Hz: "On" for 250 ms, followed by "Off" for 250 ms.

Table 45: Definition of the LED states communication status

Ethernet status PROFINET IO-Controller





LED	Color	State	Description
LINK Ch0: (11) , Ch1: (8)	LED green		
	 (green)	On	The device is linked to the Ethernet.
	 (off)	Off	The device has no link to the Ethernet.
RX/TX Ch0: (9) , Ch1: (6)	LED yellow		
	 (yellow)	Flickering (load dependent)	The device sends/receives Ethernet frames.
	 (off)	Off	The device does not send/receive Ethernet frames.

Table 46: Ethernet status PROFINET IO-Controller

LED state	Definition
Flickering (load dependent)	The LED turns on and off with a frequency of approximately 10 Hz to indicate high Ethernet activity: "On" for approximately 50 ms, followed by "Off" for 50 ms. The LED turns on and off in irregular intervals to indicate low Ethernet activity.

Table 47: Definition of the LED state Ethernet status

5.11 PROFINET IO-Device

For the PROFINET IO-Device protocol, the communication LEDs **SF** (system failure) and **BF** (bus failure) as well as the Ethernet LEDs **LINK** and **RX/TX** can assume the states described below. This description is valid from stack version V3.x (V3).

Communication status PROFINET IO-Device

LED	Color	State	Description
SF (System Failure) Position in the device overview: (10)	Duo LED red/green		
	● (off)	Off	No error
	☀ (red)	Flashing (1 Hz, 3 s)	DCP signal service is initiated via the bus.
	● (red)	On	Watchdog timeout; channel, generic or extended diagnosis present; system error
BF (Bus Failure) Position in the device overview: (7)	Duo LED red/green		
	● (off)	Off	No error
	☀ (red)	Flashing (2 Hz)	No data exchange
	● (red)	On	No configuration; or low speed physical link; or no physical link

Table 48: Communication status PROFINET IO-Device

LED state	Definition
Flashing (1 Hz, 3 s)	The LED turns on and off for 3 seconds with a frequency of 1 Hz: "On" for 500 ms, followed by "Off" for 500 ms.
Flashing (2 Hz)	The LED turns on and off with a frequency of 2 Hz: "On" for 250 ms, followed by "Off" for 250 ms.

Table 49: Definition LED states communication status

Ethernet status PROFINET IO-Device

LED	Color	State	Description
LINK Ch0: (11) , Ch1: (8)	LED green		
	● (green)	On	The device is linked to the Ethernet.
	● (off)	Off	The device has no link to the Ethernet.
RX/TX Ch0: (9) , Ch1: (6)	LED yellow		
	☀ (yellow)	Flickering (load dependent)	The device sends/receives Ethernet frames.
	● (off)	Off	The device does not send/receive Ethernet frames.

Table 50: Ethernet status PROFINET IO-Device

LED state	Definition
Flickering (load dependent)	The LED turns on and off with a frequency of approximately 10 Hz to indicate high Ethernet activity: "On" for approximately 50 ms, followed by "Off" for 50 ms. The LED turns on and off in irregular intervals to indicate low Ethernet activity.

Table 51: Definition LED states Ethernet status

5.12 Sercos Master

For the Sercos Master protocol, the communication LEDs **STA** and **ERR** as well as the Ethernet LED **L/A** can assume the states described below. This description is valid from stack version V2.1.

Communication status Sercos Master

















LED	Color	State	Description
STA Position in the device overview: (10)	Duo LED red/green		
	 (green)	On	CP4: Communication phase 4
	 (green)	Triple flash	CP3: Communication phase 3
	 (green)	Double flash	CP2: Communication phase 2
	 (green)	Single flash	CP1: Communication phase 1
	 (green)	Blinking (2.5 Hz)	CP0: Communication phase 0
	 (green)	Flickering (10 Hz)	Master is not configured and is in NRT. After a status change this isn't indicated again
	 (off)	Off	NRT: Non Real-Time Mode
ERR Position in the device overview: (7)	Duo LED red/green		
	 (red)	Single flash	Bus Sync error threshold
	 (red)	Double flash	Internal Stop of the bus cycle
	 (red)	Triple flash	DPM watchdog has expired.
	 (red)	Quadruple flash	No Master license present in the device.
	 (red)	Blinking (2.5 Hz)	Error in the configuration database.
	 (red)	Single flickering	Channel Init was executed at the Master. Transient state that may not visible at all.
	 (red)	Double flickering	Slave is missing. Unconfigured slave No matching mandatory slave list No bus connected Duplicate Sercos address Invalid Sercos address
	 (red)	Flickering (10 Hz)	Boot-up was stopped due to an error.
	 (off)	Off	No error

Table 52: Communication status Sercos Master

LED state	Definition
Single flash	The LED shows one short flash (200 ms) followed by a long "Off" phase (1,000 ms).
Double flash	The LED shows a sequence of two short flashes (each 200 ms), separated by a short "Off" phase (200 ms). The sequence is finished by a long "Off" phase (1,000 ms).
Triple flash	The LED shows a sequence of three short flashes (each 200 ms), separated by a short "Off" phase (200 ms). The sequence is finished by a long "Off" phase (1,000 ms).
Quadruple flash	The LED shows a sequence of four short flashes (each 200 ms), separated by a short "Off" phase (200 ms). The sequence is finished by a long "Off" phase (1,000 ms).
Blinking (2.5 Hz)	The LED turns on and off with a frequency of 2.5 Hz: "On" for 200 ms, followed by "Off" for 200 ms.
Single flickering	The LED is switched on and off once: "On" for 50 ms, followed by "Off" for 500 ms.

LED state	Definition
Double flickering	The LED is switched on and off and on once: "On" / "Off" / "On" each for approximately 50 ms, followed by "Off" for 500 ms.
Flickering (10 Hz)	The LED turns on and off with a frequency of 10 Hz: "On" for 50 ms, followed by "Off" for 50 ms.

Table 53: Definition of the LED states communication status

Ethernet status Sercos Master





LED	Color	State	Description
L/A Ch0: (11) , Ch1: (8)	LED green		
	 (green)	On	Link: The device is linked to the Ethernet, but does not send/receive Ethernet frames.
	 (green)	Flickering (load dependent)	Activity: The device is linked to the Ethernet and sends/receives Ethernet frames.
	 (off)	Off	The device has no link to the Ethernet.
Ch0: (9) , Ch1: (6)	LED yellow		
	 (off)	Off	This LED is not used.

Table 54: Ethernet status Sercos Master

LED state	Definition
Flickering (load dependent)	The LED turns on and off with a frequency of approximately 10 Hz to indicate high Ethernet activity: "On" for approximately 50 ms, followed by "Off" for 50 ms. The LED turns on and off in irregular intervals to indicate low Ethernet activity.

Table 55: Definition of the LED state Ethernet status

5.13 Sercos Slave

For the Sercos Slave protocol, the communication LED **S** as well as the Ethernet LED **L/A** can assume the states described below. This description is valid from stack version V3.2.

Communication status Sercos Slave













LED	Color	State	Description
S Position in the device overview: (10)	Duo-LED red/green (orange = red/green simultaneously)		
	 (green)	On	CP4: Communication phase 4: Normal operation, no error
	 (green)	Flashing (2 Hz)	Loopback: The network state has changed from „fast-forward“ to „loopback“.
	 (green/orange)	Flashing (1 x green/3s)	CP3: Communication phase 3
		(2 x green/3s)	CP2: Communication phase 2
		(1 x green/3s)	CP1: Communication phase 1
	 (orange)	On	CP2: Communication phase 0
	 (orange/green)	Flashing (2 Hz)	HP0: Hot-plug mode
		(1 x orange/3s)	HP1: Hot-plug mode
		(2 x orange/3s)	HP2: Hot-plug mode
	 (orange)	Flashing (2 Hz)	Identification: Invoked by (C-DEV.Bit15 in the Device Control) Or SIP Identification Request
	 (green/red)	Flashing (2 Hz, min. 2s)	MST losses ≥ (S-0-1003/2): The communication warning (S-DEV.Bit 15) is present in the device status.
	 (red/orange)	Flashing (2 Hz)	Application error (C1D): See GDP & FSP Status codes class error.
 (red)	Flashing (2 Hz)	Watchdog error: Application is not running.	
 (red)	On	Communication Error (C1D): Error detected according to Sercos third generation Class 1 Diagnosis, see SCP Status codes class error.	
 (off)	Off	NRT-Mode: (Non Real-Time Mode) No Sercos Communication	
Position in the device overview: (7)	Duo LED red/green		
	 (off)	Off	This LED is not used.

Table 56: Communication status Sercos Slave

LED state	Definition
Flashing (2 Hz)	The LED turns on and off with a frequency of 2 Hz: <i>one color:</i> "On" for appr. 250 ms, followed by "Off" for appr. 250 ms. <i>two colors:</i> First color for appr. 250 ms, followed by the second color for appr. 250 ms.
Flashing (1 x green/3s)	Flashing green for 250 ms, then orange on for 2 second and 750 ms.
Flashing (2 x green/3s)	Flashing green / orange / green, each for 250 ms, then orange on for 2 seconds and 250 ms.
Flashing (3 x green/3s)	Flashing green / orange / green / orange / green, each for 250 ms, then orange on for 1 second and 750 ms.
Flashing (1 x orange /3s)	Flashing orange for 250 ms, then green on for 2 second an 750 ms.
Flashing (2 x orange /3s)	Flashing orange / green / orange, each for 250 ms, then green on for 2 seconds and 250 ms.

Table 57: Definition of the LED states communication status

Ethernet status Sercos Slave





LED	Color	State	Description
L/A Ch0: (11) , Ch1: (8)	LED green		
	 (green)	On	Link: The device is linked to the Ethernet, but does not send/receive Ethernet frames.
	 (green)	Flickering (load dependent)	Activity: The device is linked to the Ethernet and sends/receives Ethernet frames.
	 (off)	Off	The device has no link to the Ethernet.
Ch0: (9) , Ch1: (6)	LED yellow		
	 (off)	Off	This LED is not used.

Table 58: Ethernet status Sercos Slave

LED state	Definition
Flickering (load dependent)	The LED turns on and off with a frequency of approximately 10 Hz to indicate high Ethernet activity: "On" for approximately 50 ms, followed by "Off" for 50 ms. The LED turns on and off in irregular intervals to indicate low Ethernet activity.

Table 59: Definition of the LED state Ethernet status

5.14 VARAN Client

For the VARAN Client protocol, the communication LEDs **RUN** and **ERR** as well as the Ethernet LEDs **LINK IN** and **LINK OUT** or **ACT IN** and **ACT OUT** can assume the states described below. This description is valid from stack version V1.0.

Communication status VARAN Client







LED	Color	State	Description
RUN Position in the device overview: (10)	Duo LED red/green		
	 (green)	On	Configured and communication is active.
	 (green)	Blinking (5 Hz)	Configured and communication is inactive.
	 (off)	Off	Not configured.
ERR Position in the device overview: (7)	Duo LED red/green		
	 (off)	Off	Configured.
	 (red)	Blinking (5 Hz)	Not configured.
	 (red)	On	Communication error occurred.

Table 60: Communication status VARAN Client

LED state	Definition
Blinking (5 Hz)	The LED turns on and off with a frequency of 5 Hz: "On" for 100 ms, followed by "Off" for 100 ms.

Table 61: Definition of the LED states communication status

Ethernet status VARAN Client





LED	Color	State	Description
LINK IN Ch0: (11) LINK OUT , Ch1: (8)	LED green		
	 (green)	On	The device is linked to the Ethernet.
	 (off)	Off	The device has no link to the Ethernet.
ACT IN Ch0: (9) ACT OUT , Ch1: (6)	LED yellow		
	 (yellow)	Flickering (load dependent)	The device sends/receives Ethernet frames.
	 (off)	Off	The device does not send/receive Ethernet frames.

Table 62: Ethernet status VARAN Client

LED state	Definition
Flickering (load dependent)	The LED turns on and off with a frequency of approximately 10 Hz to indicate high Ethernet activity: "On" for approximately 50 ms, followed by "Off" for 50 ms. The LED turns on and off in irregular intervals to indicate low Ethernet activity.

Table 63: Definition of the LED state Ethernet status

6 Connectors

6.1 Ethernet RJ45 socket

100BASE-TX and 10BASE-T



Note:

The device supports the Auto-Crossover function causing RX and TX to be exchanged where appropriate. The following figure shows the RJ45 standard pin assignment.

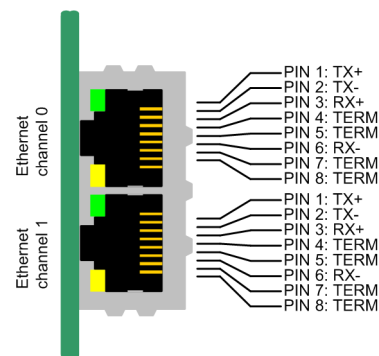

Figure 8: Ethernet pin assignment at the RJ45 socket

Pin	Signal	Meaning
1	TX+	Transmit data positive channel
2	TX-	Transmit data negative channel
3	RX+	Receive data positive channel
4	Term 1	Bridged and terminated to PE via RC link*
5	Term 1	
6	RX-	Received data negative channel
7	Term 2	Bridged and terminated to PE via RC link*
8	Term 2	
*Bob Smith Termination		

Table 64: Ethernet pin assignment at the RJ45 socket



Note:

The RJ45 connector may only be used for LAN, not for telecommunications connections.

6.2 Ethernet M12 socket

Real-time Ethernet 2 x M12 connectors (according to DIN EN 61076 2 101/ IEC 61076 2 101), D-coded socket.



Note:

The device supports the Auto Crossover function and can therefore switch RX and TX. The following figure shows the M12 standard pin assignment.

Ethernet	Pin	Signal	Description
 <p>M12, D-coded, socket, 4-pin</p>	1	TX+	Send data positive
	2	RX+	Receive data positive
	3	TX-	Send data negative
	4	RX-	Receive data negative
	Housing	Shielding	Shield connection, housing is connected to functional earth.

Table 65: Ethernet

6.3 Data of the Ethernet connection

For the Ethernet interface use RJ45 plugs and twisted pair cable of category 5 (CAT5) or higher, which consists of 4 twisted cores and has a maximum transfer rate of 100 MBit/s (CAT5).

	100BASE-TX and 10BASE-T
Medium	2 x 2 twisted pair copper cables, CAT5 (100 MBit/s)
Length of cable	Max. 100 m
Transfer rate	10 MBit/s/100 MBit/s

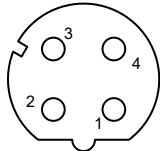
Table 66: Ethernet connection data 100BASE-TX and 10BASE-T

6.4 Usability of hubs and switches

The use of hubs or switches is prohibited or permitted for the respective communication systems. The following table shows the usability of hubs and switches per communication system:

Communication system	Hub	Switch
CC-Link IE Field Basic Slave	Forbidden	Star topology, with Layer 2 switch (must support 100 Mbit/s, 1 Gbit/s support is optional)
EtherCAT	Forbidden	Only permitted between EtherCAT Master and first EtherCAT Slave (100 MBit/s, full duplex)
EtherNet/IP	Allowed	Allowed (10 MBit/s/100 MBit/s, full or half duplex, auto-negotiation)
Open Modbus/TCP	Allowed	Allowed (10 MBit/s/100 MBit/s, full or half duplex, auto-negotiation)
POWERLINK	Allowed	Forbidden
PROFINET IO	Forbidden	Only allowed if the switch supports 'priority tagging' and LLDP (100 MBit/s, full duplex)
Sercos	Forbidden	Forbidden
VARAN	Forbidden	Forbidden

Table 67: Usability of hubs and switches

6.5 Cable connector Ethernet X700, on CIFX M3042100BM

Pin assignment for cable connector Ethernet X700 (BM20B-SRDS-G-T) on the basic card CIFX M3042100BM, cable 20-pin Ethernet and status LEDs

Pin	Name	Description	Type
1	GND	Ground	Power
2	3V3	3.3V Power	Power
3	LED COM0-GREEN	LED COM0 (green)	Output
4	LED COM0-RED	LED COM0 (red)	Output
5	-	(not used)	NC
6	LED COM1-GREEN	LED COM1 (green)	Output
7	LED LINK0	LED LINK0 (yellow)	Output
8	LED ACT0	LED ACT0 (green)	Output
9	RSTOUT#	Reset out	Output
10	LED COM1-RED	LED COM01 (red)	Output
11	CH0_TXP	Channel 0 TX+	Output
12	CH0_TXN	Channel 0 TX-	Output
13	CH0_RXP	Channel 0 RX+	Input
14	CH0_RXN	Channel 0 RX-	Input
15	CH1_TXP	Channel 1 TX+	Output
16	CH1_TXN	Channel 1 TX-	Output
17	CH1_RXP	Channel 1 RX+	Input
18	CH1_RXN	Channel 1 RX-	Input
19	LED LINK1	LED LINK1 (yellow)	Output
20	LED ACT1	LED ACT1 (green)	Output

Table 68: Pin assignment for cable connector Ethernet X700 (BM20B-SRDS-G-T), on CIFX M3042100BM

6.6 Cable connector Ethernet X1, AIFX-RE

Pin assignment for cable connector Ethernet X1, AIFX-RE, cable 20-pin Ethernet and status LEDs

Pin	Name	Description	Type
1	GND	Ground	Power
2	3V3	3.3V Power	Power
3	LED COM0-GREEN	LED COM0 (green)	Input
4	LED COM0-RED	LED COM0 (red)	Input
5	-	(not used)	NC
6	LED COM1-GREEN	LED COM1 (green)	Input
7	LED LINK0	LED LINK0 (yellow)	Input
8	LED ACT0	LED ACT0 (green)	Input
9	RSTOUT#	Reset out	Input
10	LED COM1-RED	LED COM01 (red)	Input
11	CH0_TXP	Channel 0 TX+	Input
12	CH0_TXN	Channel 0 TX-	Input
13	CH0_RXP	Channel 0 RX+	Output
14	CH0_RXN	Channel 0 RX-	Output
15	CH1_TXP	Channel 1 TX+	Input
16	CH1_TXN	Channel 1 TX-	Input
17	CH1_RXP	Channel 1 RX+	Output
18	CH1_RXN	Channel 1 RX-	Output
19	LED LINK1	LED LINK1 (yellow)	Input
20	LED ACT1	LED ACT1 (green)	Input

Table 69: Pin assignment for cable connector Ethernet X1, AIFX-RE

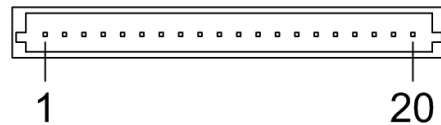

Figure 9: Cable connector Ethernet X1; 1x20 pins, AIFX-RE

6.7 Cable connector Ethernet X2, AIFX-RE\M12

Pin assignment for cable connector Ethernet X2, AIFX-RE\M12, cable 20-pin Ethernet and status LEDs

Pin	Name	Description
1	ACT1	CH1_ACTIVITY (EN LED YEL1)
2	LINK1	CH1_LINK (EN LED GRN1)
3	CH1_RXN	Channel 1 RX-
4	CH1_RXP	Channel 1 RX+
5	CH1_TXN	Channel 1 TX-
6	CH1_TXP	Channel 1 TX+
7	CH0_RXN	Channel 0 RX-
8	CH0_RXP	Channel 0 RX+
9	CH0_TXN	Channel 0 TX-
10	CH0_TXP	Channel 0 TX+
11	STA1_R	STA1_red (RE LED COM1)
12	RST	RSTOUT
13	ACT0	CH0_ACTIVITY (EN LED YEL0)
14	LINK0	CH0_LINK (EN LED GRN0)
15	STA1_G	STA1_green (RE LED COM1)
16	-	-
17	STA0_R	STA0_red (RE LED COM0)
18	STA0_G	STA0_green (RE LED COM0)
19	3V3	3.3V Power
20	GND	Ground

Table 70: Pin assignment for cable connector Ethernet X2, AIFX-RE\M12

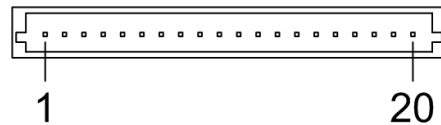

Figure 10: Cable connector Ethernet X2; 1x20 pins, AIFX-RE\M12

6.8 Cable connector LED signals X3, AIFX-RE\M12

Pin assignment for cable connector LED signals X3, AIFX-RE\M12, cable 10-pin Ethernet and status LEDs

Pin	Name	Description
1	LINK0	CH0_LINK (EN LED GRN0)
2	ACT0	CH0_ACTIVITY (EN LED YEL0)
3	LINK1	CH1_LINK (EN LED GRN1)
4	ACT1	CH1_ACTIVITY (EN LED YEL1)
5	STA0_G	STA0_green (RE LED COM0)
6	STA0_R	STA0_red (RE LED COM0)
7	STA1_G	STA1_green (RE LED COM1)
8	STA1_R	STA1_red (RE LED COM1)
9	GND	Ground
10		

Table 71: Pin assignment for cable connector LED signals X3, AIFX-RE\M12

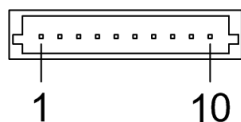

Figure 11: Cable connector LED signals X3; 1x10 pins, AIFX-RE\M12



Note:

The outputs on the cable connector LED signals X3 can drive max. 5 mA. This means that the maximum permissible current per external LED is 5 mA. If this maximum current is not sufficient, an external driver is required previous to the LED.

6.9 PCI Express M.2 bus

The following table applies for pin assignment on the PCI Express M.2 bus of the PC card CIFX M3042100BM (basic card).

Pin	Name	Description	Type
1	GND	Return current path.	Power
2	3.3V	3.3V supply	Power
3	GND	Return current path.	Power
4	3.3V	3.3V supply	Power
5	NC	(not used)	-
6	NC	(not used)	-
7	USB_D+	USB data differential pair positive polarity	In / Out
8	NC	(not used)	-
9	USB_D-	USB data differential pair negative polarity	In / Out
10	BOOT	Reserved (vendor defined pin for production purposes only). <i>In hardware revision 1 and 2 pin 10 is not assigned.</i>	Input
11	NC	(not used)	-
12-19	-	KEY B	-
20	SYNC0	synchronisation pin for realtime systems	Output
21	GND	Return current path.	Power
22	SYNC1	synchronisation pin for realtime systems	Output
23-26	NC	(not used)	-
27	GND	Return current path.	Power
28-32	NC	(not used)	-
33	GND	Return current path.	Power
34-38	NC	(not used)	-
39	GND	Return current path.	Power
40	NC	(not used)	-
41	PETN0	PCIe TX/RX Differential signals defined by the PCI Express CEM Specification.	Output
42	NC	(not used)	-
43	PETP0	PCIe TX/RX Differential signals defined by the PCI Express CEM Specification.	Output
44	NC	(not used)	-
45	GND	Return current path.	Power
46	NC	(not used)	-
47	PERN0	PCIe TX/RX Differential signals defined by the PCI Express CEM Specification.	Input
48	NC	(not used)	-
49	PERP0	PCIe TX/RX Differential signals defined by the PCI Express CEM Specification.	Input
50	PERST#	PCIe Reset is a functional reset to the card as defined by the PCI Express Mini CEM Specification.	Input
51	GND	Return current path.	Power
52	CLKREQ#	PCIe Clock Request is a reference clock request signal as defined by the PCI Express Mini CEM Specification. This signal is also used by L1PM Substates. Open Drain with pull up on Platform. Active Low.	In / Out
53	REFCLKN	PCIe Reference Clock signals (100 MHz) defined by the PCI Express CEM Specification.	Input
54	PEWAKE#	PCIe WAKE#. Open Drain with pull up on Platform. Active Low when used as PEWAKE#. When the Adapter supports wakeup, this signal is used to request that the system return from a sleep/suspend state to service a function-initiated wake event. When the Adapter supports OBFF mechanism, the PEWAKE#signal is used for OBFF signaling.	In / Out
55	REFCLKP	PCIe Reference Clock signals (100 MHz) defined by the PCI Express CEM Specification.	Input
56	NC	(not used)	-
57	GND	Return current path.	Power
58	NC	(not used)	-

Pin	Name	Description	Type
59-66	-	KEY M	-
67-69	NC	(not used)	-
70	3.3V	3.3V supply	Power
71	GND	Return current path.	Power
72	3.3V	3.3V supply	Power
73	GND	Return current path.	Power
74	3.3V	3.3V supply	Power
75	GND	Return current path.	Power

Table 72: Pin assignment PCI Express M.2 bus X200, CIFX M3042100BM

7 Technical data

7.1 PC card CIFX M3042100BM-RE\F

Category	Parameter	Value	
Part		Name	Part number
	PC card (basic card with AIFX-RE)	CIFX M3042100BM-RE\F	1456.101
	PC card (basic card with AIFX-RE\M12)	CIFX M3042100BM-RE\F\M12	1456.121
	Basic card	CIFX M3042100BM	1456.100
	Function	Communication interface M.2 3042 key B+M, with PCI Express M.2 interface and Ethernet interface. The use refers to master and slave systems.	
Communication controller	Type	netX 100	
Integrated memory	RAM	8 MB SDRAM	
	Flash	4 MB serial Flash-EPROM	
	Size of the Dual-Port Memory	64 Kbyte	
System interface	Bus type	PCI Express M.2, one-lane port	
	Transmission rate	33 MHz	
	Data access	DPM or DMA (Direct Memory Access)	
	Dual-Port Memory (DPM) data access width	32-Bit	
Ethernet communication	Supported Real-Time Ethernet communication systems (determined by the loaded firmware)	CC-Link IE Field Basic Slave	
		EtherCAT Master	
		EtherCAT Slave	
		EtherNet/IP Scanner	
		EtherNet/IP Adapter	
		Open Modbus/TCP	
		POWERLINK Controlled Node	
		PROFINET IO-Controller	
		PROFINET IO-Device	
		Sercos Master	
	Sercos Slave		
VARAN Client			
	Ethernet frame types	Ethernet II	
Ethernet interface	Transmission rate	100 MBit/s, 10 MBit/s (depending on the firmware loaded)	
	Interface type	100BASE-TX, 10BASE-T (depending on firmware loaded)	
	Half duplex/full duplex	depending on the firmware loaded, supported (at 100 MBit/s)	
	Auto-negotiation	depending on the firmware loaded	
	Auto crossover	depending on the firmware loaded	
	Detached network interface Ethernet	AIFX-RE or AIFX-RE\M12 Important! Operating the PC card CIFX M3042100BM-RE\F (or CIFX M3042100BM-RE\F\M12) requires proper connection of the detached network interface Ethernet AIFX-RE (or AIFX-RE\M12) to the basic card.	
	Connction AIFX-RE AIFX-RE\M12	Cable connector Ethernet X700 (JST BM20B-SRDS-G-TF, 1.0 mm pitch)	
Diagnosis with LEDs	LEDs	SYS	System status

Category	Parameter	Value	
Power supply	Supply voltage	+3.3 VDC ±5%	
	Current consumption at 3.3 V	650 mA (maximum)	
	Connector	via PCI Express Bus M.2	
Environmental conditions	Operating temperature range*	-20 °C ... +65 °C	-20 °C ... +50 °C
	*Air flow, during measurement:	0.5 m/s	0.0 m/s
	Storage temperature range	-40 °C ... +85 °C	
	Humidity	10% ... 95% relative humidity, no condensation permitted	
	Environment	The device must be used only in a pollution degree 2 environment (or better).	
Device	Dimensions (L x W x H)	42 x 30 x 7.0 mm	
	Component heights	The component height on the top of the basic card CIFX M3042100BM exceeds the height of 1.5 mm specified by the standard, because the height of the cable connectors (Ethernet X801, or fieldbus X700), including the cable, is approximately 8.5 mm above the circuit board. The component height on the bottom of the basic card CIFX M3042100BM complies with the standard specifications.	
	Mounting/installation	PCI Express slot (3.3 V), for M.2 type 3042-D3, Dual key B-M (Socket 1 Connectivity)	
EMC Compliance	CE sign	Yes	
	UKCA sign	Yes	
	Emission	DIN EN 61000-6-3/ BS EN 61000-6-3	
	Immunity	DIN EN 61000-6-2/ BS EN 61000-6-2	
	Documentation to prove the restriction of hazardous substances	EN 50581 / BS EN 50581	
	RoHS	Yes	
Configuration and download	Configuration software (including downloading and updating firmware and configuration)	SYCON.net for netX	

Table 73: Technical data CIFX M3042100BM-RE\F

7.2 PCI identifier on the PCI Express M.2 bus

The PC card CIFX M3042100BM-RE\F is a multifunction device on the PCI Express M.2 bus and requires two PCI identifiers. The following identifiers apply:

PCI identifier	Value
Vendor ID	0x15CF
Device ID	0x0000
Subsystem vendor ID	0x0000
Subsystem device ID	0x0000

Table 74: PCI identifier on the PCI Express M.2 bus for CIFX M3042100BM

7.3 AIFX-RE

Category	Parameter	Value	
Part	Name	AIFX-RE	
	Part number	2800.100	
	Description	Detached network interface Ethernet RJ45 for all netX 100-based devices.	
Interface PC card	Connector	Cable connector Ethernet X1 (JST SM20B-SRSS-TB(LF)(SN), 1.0 mm pitch)	
Ethernet interface	Galvanic isolation	isolated	
	Isolation voltage	1000 VDC (tested for 1 minute)	
	Connector	2 * RJ45 socket	
Diagnosis with LEDs	LEDs (on the reverse side of the device)	COM0	Communication status LED 0 (Duo LED)
		COM1	Communication status LED 1 (Duo LED)
		LED yellow	To RJ45Ch0 and RJ45Ch1, for Ethernet link status, Ethernet activity status, and other status
		LED green	
Power supply	Connector	Cable connector Ethernet X1	
Environmental conditions	Operating temperature range*	-40 °C ... +85 °C	
	*Air flow, during measurement	0.5 m/s	
	Storage temperature range	-40 °C ... +85 °C	
	Humidity	10% ... 95% relative humidity, no condensation permitted	
	Environment	The device must be used only in a pollution degree 2 environment (or better).	
Device	Dimensions (L x W x H)	30.6 x 42.3 x 17.9 mm, front panel width = 18.5 mm	
	Mounting/installation	On the netX 100-based basic card: Cable connector Ethernet X700. Mounting on the housing of the PC or connecting device.	
EMC Compliance	CE sign	Yes	
	UKCA sign	Yes	
	Emission, Immunity	Tested together with the corresponding basic card.	
	RoHS	Yes	

Table 75: Technical data AIFX-RE

7.4 AIFX-RE\M12

Category	Parameter	Value	
Part	Name	AIFX-RE\M12	
	Part number	2800.101	
	Description	Detached network interface Ethernet M12 for all netX 100-based devices.	
Interface PC card	Connector	Cable connector Ethernet X2 (JST SM20B-SRSS-TB(LF)(SN), 1.0 mm pitch)	
Ethernet interface	Galvanic isolation	isolated	
	Isolation voltage	1000 VDC (tested for 1 minute)	
	Connector	2 * M12 socket	
Diagnosis with LEDs Alternative use: 1. LEDs via the lightpipe or 2. LED signals via cable connector LED signals X3	LEDs (via the lightpipe)	COM0	Communication status LED 0 (Duo LED)
		COM1	Communication status LED 1 (Duo LED)
		LED yellow	To RJ45Ch0 and RJ45Ch1, for Ethernet link status, Ethernet activity status, and other status
		LED green	
	Cable connector LED signals X3 (if IP67 is required)	Signals for the communication LEDs COM0 and COM1 (green/red each), respectively the Ethernet LEDs Ch0 and Ch1 Ethernet Link status (green), Ethernet Activity status (yellow) and further status green respectively yellow. The meaning of the LEDs connected via the signals depends on the loaded firmware. For the pin assignment of the LED signals see section <i>Cable connector LED signals X3, AIFX-RE\M12</i> [▶ page 55]. Maximum current consumption per external LED: 5 mA	
Power supply	Connector	Cable connector Ethernet X2	
Environmental conditions	Operating temperature range*	-30 °C ... +70 °C	
	*Air flow, during measurement	0.5 m/s	
	Storage temperature range	-40 °C ... +85 °C	
	Humidity	10% ... 95% relative humidity, no condensation permitted	
	Environment	The device must be used only in a pollution degree 2 environment (or better).	
Device	Dimensions (L x W x H)	60 x 36 x 15.5 mm	
	Mounting/installation	On the netX 100-based basic card: Cable connector Ethernet X700. Mounting on the housing of the PC or connecting device.	
EMC Compliance	CE sign	Yes	
	UKCA sign	Yes	
	Emission, Immunity	Tested together with the corresponding basic card.	
	RoHS	Yes	

Table 76: Technical data AIFX-RE

7.5 Communication protocols

7.5.1 CC-Link IE Field-Basic-Slave

Parameter	Description
Maximum number of cyclic input data	RY data: 128 bytes (1024 bits) RWw Data: 512 words (16 Bit)
Maximum number of cyclic output data	RX data: 128 bytes (1024 bits) RWr Data: 512 words (16 Bit)
Occupied Stations	1 ... 16 1 station has 64 bits of RY data, 32 words of RWw data, 64 bits of RX data, and 32 words of RWr data.
Acyclic communication	SLMP Server and Client
Data transport layer	Ethernet II, IEEE 802.3
Baud rate	100 MBit/s
Ports	Cyclic data: 61450 (UDP) Discovery and SLMP Server: 61451 (UDP) SLMP Parameter: 45237 (UDP) SLMP Communication: 20000 (UDP)
Reference to firmware/stack version	V1.2

Table 77: Technical data CC-Link IE Field Basic Slave

7.5.2 EtherCAT Master

Parameter	Description
Maximum number of EtherCAT Slaves	Maximum 388 slaves if RCX_GET_SLAVE_HANDLES_REQ service is used. The usable number of slaves depends on several parameters: available memory size for the configuration file (see 'Configuration file'), used cycle time, frame runtimes.
Maximum number of cyclic input data	Approx. 4600 bytes if no LRW (Logical Read Write) commands are used for process data
Maximum number of cyclic output data	Approx. 4600 bytes if no LRW (Logical Read Write) commands are used for process data
Acyclic communication	CoE (CANopen over EtherCAT): SDO, SDOINFO, Emergency FoE (File Access over EtherCAT) SoE (Servo Drive Profile over EtherCAT) EoE (Ethernet over EtherCAT) Configurable with SYCON.net: CoE If the ETHERCAT.XML file contains corresponding configuration information (e.g. created with "EtherCAT Configurator"), the following functions can be used: CoE, SoE, EoE
Mailbox protocols	CoE, EoE, FoE, SoE
Functions	Distributed Clocks Redundancy Slave diagnosis Bus scan
Minimum bus cycle time	250 µs, depending on the used slaves and the used number of cyclic input and output data.
Topology	Line or ring
Slave station addresses	1 - 14335
Data transport layer	Ethernet II, IEEE 802.3, 100 MBit/s, full-duplex
Configuration file (ETHERCAT.XML or CONFIG.NXD)	Device with RAM disk: maximum 1 MByte (CONFIG.NXD), device with flash disk: maximum 3 MByte (ETHERCAT.XML)
Synchronisation via ExtSync	Supported (not configurable with SYCON.net)
"ENI Slave-to-Slave copy infos"	Supported (not configurable with SYCON.net)
Hot Connect	Supported (not configurable with SYCON.net)
EoE (Ethernet over EtherCAT)	Via NDIS
Restrictions	The size of the bus configuration file is limited by the size of the RAM disk (1 MByte) or the FLASH disk (3 MByte). Store-and-forward switches must not be used in the network topology due to the hard receive time requirements. RCX_GET_SLAVE_HANDLES_REQ can only be used up to max. 388 slaves. Process data are limited to max. 5760 bytes by the dual-port memory.
Reference to firmware/stack version	V4.5

Table 78: Technical data EtherCAT Master

7.5.3 EtherCAT Slave

Parameter	Description
Maximum number of cyclic input data	256* bytes
Maximum number of cyclic output data	256* bytes
Acyclic communication (CoE)	SDO SDO Master Slave SDO Slave Slave (depending on the ability of the master)
Type	Complex Slave
Protocols	SDO server-side protocol CoE Emergency messages (CoE) Ethernet over EtherCAT (EoE) File Access over EtherCAT (FoE) AoE (ADS over EtherCAT) SoE (Servo Profile over EtherCAT) SoE and CoE cannot be used at the same time.
State Machine	ESM (EtherCAT State Machine)
Synchronization modes	Freerun: The application of the EtherCAT slave is not synchronized to EtherCAT Synchronous with SYNCMAN event: Application of EtherACT slave is synchronized to the SM2 or SM3 event Synchronous with SYNC event: Application of EtherACT slave is synchronized to the SYNC0 or SYNC1 event
Functions	Emergency Distributed clocks (DC) PDI watchdog Integrated CoE Object Directory (ODV3)
Number of FMMU channels	3
Number Of Sync Manager channels	4
Ethernet interface	Two Ethernet interfaces 100BASE-TX Integrated dual PHY (supports Auto-Negotiation and Auto-Crossover)
Data transport layer	Ethernet II, IEEE 802.3

Parameter	Description
Restrictions	LRW not supported (no direct slave-to-slave communication) No DC latch function No support for bit-wise FMMU mapping (Exception: Fill Status of Transmit Mailbox) Restricted DC sync signal generation <ul style="list-style-type: none"> • Single shot mode is not supported • Acknowledge mode is not supported Restricted DC control function <ul style="list-style-type: none"> • No adjustment of the registers "Speed Counter Start" (0x0930:0x931) • Register "Speed Counter Diff" (0x0932:0x933) is not shown "Physical Read-Write commands" (APRW, FPRW, BRW) are not supported
Reference to firmware/stack version	V4.8

Table 79: Technical data EtherCAT Slave

Note: * The loadable firmware supports for the number of cyclic input data and for cyclic output data in total up to 512 bytes. If more than 256 bytes for input data or for output data shall be exchanged via EtherCAT, then a customer specific XML file is necessary. Additionally the following formula applies: The sum of the input data length and the output data length may not exceed 512 bytes, where each length has to be rounded up to the next multiple of 4 for this calculation.

7.5.4 EtherNet/IP Scanner

Parameter	Description
Maximum number of EtherNet/IP connections	64 connections for implicit and explicit
Maximum number of cyclic input data	5712 bytes
Maximum number of cyclic output data	5760 bytes
Maximum number of cyclic input data per adapter	504 bytes per adapter per frame
Maximum number of cyclic output data per adapter	504 bytes per adapter per frame
I/O connection type	Cyclic, minimum 1 ms (depending on used number of connections and used number of input and output data)
Maximum number of 'Unscheduled Data'	1400 bytes per frame
UCMM, Class 3	Supported
Explicit Messages, Client and Server Services	Get_Attribute_Single/All Set_Attribute_Single/All
Quick Connect	Supported
Predefined standard objects	Identity object Message Router object Assembly object Connection Manager object Ethernet Link object TCP/IP object DLR object QoS object
Max. number of application-specific objects	20
Network scan	Supported
Topology	Tree, line, ring
DLR (Device Level Ring)	Beacon based 'Ring Node'
ACD (Address Conflict Detection)	Supported
DHCP	Supported
BOOTP	Supported
Baud rate	10 and 100 MBit/s
Data transport layer	Ethernet II, IEEE 802.3
Switch function	Integrated
Restrictions	CIP Sync Services are not implemented TAGs are not supported
Reference to firmware/stack version	V2.11

Table 80: Technical data EtherNet/IP Scanner

7.5.5 EtherNet/IP Adapter

Parameter	Description
Maximum number of input data	504 bytes per assembly instance
Maximum number of output data	504 bytes per assembly instance
Maximum number of assembly instances	10
I/O connection types (implicit)	Exclusive Owner Listen Only Input Only
I/O connection trigger types	Cyclic (Minimum 1 ms*) Application triggered (Minimum 1 ms*) Change of State (Minimum 1 ms*) * depending on the number of connections and the input and output data
Explicit messages	Connected and unconnected
Unconnected Message Manager (UCMM)	Supported
Maximum number of connections	Implicit connections (Class 1): 5 Explicit connections (Class 3): 10 UCMM: 10
Predefined standard objects	Identity object (1, 0x01) Message Router object (2, 0x02) Assembly object (4, 0x04) Connection Manager (6, 0x06) DLR object (71, 0x47) QoS object (72, 0x48) TCP/IP object (245, 0xF5) Ethernet Link object (246, 0xF6)
Maximum number of user-specific objects	20
Supported features	TCP/IP, UDP/IP DHCP, BOOTP Quick Connect Device level Ring (DLR) – Media redundancy Address Conflict Detection (ACD) Quality of Service CIP reset service: Identity object: Reset service type 0 and 1
Ethernet interface	10 and 100 MBit/s Integrated switch
Duplex mode	Half-duplex, full-duplex, auto-negotiation
MDI mode	MDI, MDI-X, Auto-MDIX
Data transport layer	Ethernet II, IEEE 802.3
Restrictions	Tags are not supported. Connection type "Null forward Open" is not supported. CIP Motion is not supported. CIP Safety is not supported.
Reference to firmware/stack version	V3.6

Table 81: Technical data EtherNet/IP Adapter

7.5.6 Open Modbus/TCP

Parameter	Description
Maximum number of input data	5760 bytes (2880 registers)
Maximum number of output data	5760 bytes (2880 registers)
Acyclic communication	Read/write registers <ul style="list-style-type: none"> • Max. 125 registers per read telegram (FC 3, 4, 23) • Max. 121 registers per write telegram (FC 23) • Max. 123 registers per write telegram (FC 16) Read/write coils <ul style="list-style-type: none"> • Max. 2000 coils per read telegram (FC 1, 2) • Max. 1968 coils per write telegram (FC 15)
Modbus function codes	1, 2, 3, 4, 5, 6, 7, 15, 16, 23*, 43 * Function code 23 can be used via the packet API but not with the command table.
Protocol mode	Message mode (Client) <ul style="list-style-type: none"> • Client (using the command table in the configuration software: The data is stored in the I/O process data image) • Client and server (using the packet API: The I/O process data image is not used) E/A mode (Server) <ul style="list-style-type: none"> • (Only) Server (The data is stored in the I/O process data image)
Command table (Configuration API only)	Max. 16 server configurable Max. 256 commands
Baud rate	10 and 100 MBit/s
Data transport layer	Ethernet II, IEEE 802.3
Reference to firmware/stack version	V3.1

Table 82: Technical data Open Modbus/TCP

7.5.7 POWERLINK Controlled Node

Parameter	Description
Maximum number of cyclic input data	1490 bytes
Maximum number of cyclic output data	1490 bytes
Acyclic communication	SDO Upload/Download
Functions	SDO via ASND and UDP
Baud rate	100 MBit/s, half-duplex
Data transport layer	Ethernet II, IEEE 802.3
Ethernet POWERLINK version	V 2
Restriction	No slave to slave communication
Reference to firmware/stack version	V3.5

Table 83: POWERLINK Controlled Node

7.5.8 PROFINET IO-Controller

Parameter	Description
Maximum number of ARs (Application relation)	128 for RT communication 64 for IRT communication
Maximum number of cyclic input data	5652 bytes, including provider and consumer status data
Maximum number of cyclic output data	5700 bytes, including provider and consumer status data
Send clock	1 ms, 2 ms, 4 ms for RT mode 250 µs, 500 µs, 1 ms, 2 ms, 4 ms for IRT mode
AR performance limits	Max. 8 ARs, if any send clock < 500 µs Max. 16 ARs, if any send clock < 1 ms Max. 64 ARs, if any send clock < 2 ms
Maximum number of submodules	2048
Maximum number of data per IOCR	1440 bytes
Number of IOCRs per AR	1 Input IOCR 1 Output IOCR
Maximum number of data for acyclic read/write (record access)	65536 bytes
Maximum amount of record data per AR	16384 bytes
Alarm processing (configurable)	Stack automatically handles alarms Application processes alarms
Maximum number of ARVendorBlock	256
Maximum number of data ARVendorBlockData	512 bytes
Device Access AR CMI timeout	20 s
Functions	Automatic Name Assignment Media Redundancy Client Media Redundancy Manager (requires license)
DCP function API	Name Assignment IO-Devices (DCP set NameOfStation) Set IO-Device IP (DCP set IP) Signal IO-Device (DCP set SIGNAL) Reset IO-Device to factory settings (DCP Reset FactorySettings) Bus scan (DCP identification ALL) DCP GET
PROFINET IO specification	Implemented according to V2.3 ED2 MU3 Legacy Startup according to the PROFINET specification V2.2 supported

Parameter	Description
Restrictions	<p>The size of the bus configuration file is limited by the size of the RAM disk (1 MByte).</p> <p>The usable (minimum) cycle time depends on the number of IO-Devices used and the number of input and output data used.</p> <p>RT over UDP not supported</p> <p>"Multicast communication" not supported</p> <p>DHCP not supported (neither for PROFINET IO-Controller nor for IO-Devices)</p> <p>Only one IOCR per IO-Device per direction</p> <p>Only one DeviceAccess AR instance at a time</p> <p>MRPD is not supported</p> <p>No IRT planning by the stack</p> <p>Sync Slave not supported</p> <p>MRP Manager (Auto), the Auto Manager, not supported</p> <p>Only one fragmented acyclic service at the same time</p> <p>Multiple MRP Managers not supported</p> <p>Only one DCP service at a time</p> <p>Multiple Sync Master not supported</p> <p>System Redundancy (SA-AR) and Dynamic Reconfiguration (formerly Configuration-in-Run, CiR) not supported</p> <p>Shared input not supported</p> <p>IO-Device interface (iDevice) not supported</p>
Reference to firmware/stack version	V3.4

Table 84: Technical data PROFINET IO-Controller

7.5.9 PROFINET IO-Device

Parameter	Description
Maximum number of cyclic input data	1440 bytes (including IOPS and IOCS)
Maximum number of cyclic output data	1440 bytes (including IOPS and IOCS)
Maximum number of submodules	Depends on the firmware, can be configured via "Number of configurable submodules" in tag list. Up to 256 in general and may be smaller number for specific firmware. Note: If the application uses max. 2 APIs, the "Number of configurable submodules" can be used. Each further API reduces the total number of usable submodules by 1.
Multiple Application Relations (AR)	Depends on the firmware, can be configured via "Number of additional IO Connections (ARs)" in tag list. Up to 4 IO-ARs and one Supervisor-DA AR in general and may be smaller for numbers specific firmware.
Acyclic communication (Record objects)	Read/Write Record, max supported size can be configured via taglist.
Alarm types	Process Alarm, Diagnostic Alarm, Return Of Submodule Alarm, Plug Alarm (implicit), Pull Alarm (implicit), Update Alarm, Status Alarm, Upload and Retrieval Notification Alarm
Diagnosis entries	Depends on the firmware, can be configured via "Number of available Diagnosis buffers" in tag list. Up to 256 application diagnosis records of type Channel or Extended Channel Diagnosis in general and may be smaller number for specific firmware.
Identification & Maintenance (I&M)	I&M0 Read: Either integrated for slot 0 / subslot 1 or forwarded to the application for each submodule. I&M1-5 Read/Write: Either built in for Slot 0 / Subslot 1 or pass through to application for any submodule. I&M4 and I&M5 are inactive by default.
Topology recognition	LLDP, SNMP V1, Physical Device Record Objects
Minimum cycle time (MinDeviceInterval)	RT_CLASS_1: 1 ms (min. SendClockFactor 32) RT_CLASS_3: 250 µs (min. SendClockFactor 8)
IRT support	RT_CLASS_3
Media redundancy	MRP Client
Additional supported features	"Shared Device" "Fast Startup" (depends on hardware) Asset Management PROFInergy ASE
Baud rate	100 MBit/s
Data transport layer	Ethernet II, IEEE 802.3, MAUType 16
PROFINET IO specification	V2.3, PNIO_version 2.35 V2.2 ("legacy startup") is supported
Conformance Class	C
Application IP stack API	The lwIP IP stack can be used by the application via Socket API Packets. Up to 8 sockets are available to the Application.
Application Raw Ethernet API	Sending and Receiving Raw Ethernet Frames as Application is supported

Parameter	Description
Restrictions	<p>RT over UDP not supported.</p> <p>Multicast communication not supported.</p> <p>DHCP is not supported.</p> <p>The amount of configured I/O-data influences the minimum cycle time that can be reached.</p> <p>Only 1 Input-CR and 1 Output-CR per AR are supported.</p> <p>Little endian byte order not supported.</p> <p>System Redundancy (SR-AR) and Dynamic Reconfiguration are not supported.</p> <p>The usage of PROFINET CombinedObjectContainer is not supported.</p> <p>SharedInput is not supported.</p> <p>MRPD is not supported.</p> <p>DFP and other HighPerformance-profile related features are not supported.</p> <p>Submodules cannot be configured or used by an AR in subslot 0.</p> <p>The stack does not support usage of PDEV submodules (InterfaceSubmodule or PortSubmodule) outside of slot 0. In addition the InterfaceSubmodule is only supported in subslot 0x8000 and the PortSubmodules are only supported in subslots 0x8001 and 0x8002.</p>
Reference to firmware/stack version	V4.5

Table 85: Technical data PROFINET IO-Device

The maximum values for number of submodules, Multiple Application Relations, Acyclic communication, and Diagnosis entries are configuration parameters in the tag list of a firmware. Each of these features require resources and have to be set in order to not exceed the available resource (e.g. RAM) of a device.

7.5.10 Sercos Master

Parameter	Description
Maximum number of cyclic input data	5760 bytes (including Connection Control per Connection)
Maximum number of cyclic output data	5760 bytes (including Connection Control per Connection)
Maximum number of configurable slave devices	511
Minimum cycle time	250 μ s (depending on used number of slaves and used number of input and output data)
Acyclic communication	Service channel: Read/Write/Commands
Functions	Bus scan
Communication phases	NRT, CP0, CP1, CP2, CP3, CP4
Topology	Line and double ring
Redundancy	Supported
NRT channel	Supported
Hot plug	Supported
Cross communication	Supported, but only if the master is configured with packages by the host application program.
Baud rate	100 MBit/s, full-duplex
Data transport layer	Ethernet II, IEEE 802.3
Auto crossover	Supported
Supported Sercos version	Communication Specification Version 1.3
TCP/IP Stack	Integrated
Reference to firmware/stack version	V2.1

Table 86: Technical data Sercos Master

7.5.11 Sercos Slave

Parameter	Description
Maximum number of cyclic produced data (Tx) of all slaves	132 bytes (including Connection Control and IO Status)
Maximum number of cyclic consumed data (Rx) of all slaves	124 bytes (including Connection Control and IO Control)
Maximum number of slaves	8
Sercos addresses	1 ... 511
Minimum cycle time	250 µs (depending on used number of slaves and used number of input and output data)
Topology	Line and ring
Communication phases	NRT, CP0, CP1, CP2, CP3, CP4, HP0, HP1, HP2
Connections	Max. 2 connections: 1 consumer and 1 producer
Connection descriptors (including Connection Control and IO Status/Control)	Max. 64
Acyclic communication (service channel)	Read/write/standard commands
Cross Communication (CC)	Supported
Baud rate	100 MBit/s
Data transport layer	Ethernet II, IEEE 802.3
Supported Sercos version	"Communication Specification" Version 1.1.2 and 1.3.1
Supported Sercos communication profiles	SCP_FixCFG Version 1.1.1 SCP_VarCFG Version 1.1.1 SCP_VarCFG Version 1.1.3 SCP_HP Version 1.1.1 SCP_SysTime Version 1.3
Supported user SCP profiles	SCP_WD Version 1.1.1 SCP_Diag Version 1.1.1 SCP_RTb Version 1.1.1 SCP_Mux Version 1.1.1 SCP_Sig 1.1.1 SCP_ExtMuX 1.1.2 SCP_RTbListProd 1.3 SCP_RTbListCons 1.3 SCP_RTbWordProd 1.3 SCP_RTbWordCons 1.3 SCP_OvSBasic 1.3 SCP_WDCon 1.3
Supported FSP profiles	FSP_IO FSP_Drive FSP_Encoder
Functions	SCP Sync SCP_NRT S/IP protocol Identification LED function
Storage of the object dictionary	Mixed mode
Restrictions	Modifications of the Service-Channel Object Dictionary will be volatile after reset, if it resides on device. Clock parameters ulDTDivClk (Content of DTDivClk register) and ulDivClkLength (DivClk Length) are not adjustable. ulDivClkLength is set to the fixed value 1 µs. Div_Clk mode 0 is not supported. ulConClkLength has a maximum of 655350 ns.

Parameter	Description
Reference to firmware/stack version	V3.5

Table 87: Technical data Sercos Slave

7.5.12 VARAN Client

Parameter	Description
Maximum number of cyclic input data	256 bytes
Maximum number of cyclic output data	256 bytes
Memory Area	Read Memory Area 1, Read Memory Area 2 Write Memory Area 1, Write Memory Area 2
Functions	Memory Read Memory Write Integrated 2 port splitter for daisy chain topology
Baud rate	100 MBit/s
Data transport layer	Ethernet II, IEEE 802.3
VARAN protocol version	1.1.1.0
Restrictions	Integrated EMAC for IP data exchange with client application not supported SPI single commands not supported
Reference to firmware/stack version	V1.1

Table 88: Technical data VARAN Client

8 Dimensions

8.1 Tolerances of PCB dimensions

The manufacturing tolerance of the PCB dimensions shown is ± 0.1 mm per milled PCB edge. For all indicated dimensions of the printed circuit board, a tolerance of ± 0.1 mm (per milled edge) $\times 2 = \pm 0.2$ mm results for the length L and for the width B respectively.

$B = [\text{width dimension of printed circuit board in mm}] \pm 0.2 \text{ mm}$

$L = [\text{Length dimension of the PCB in mm}] \text{ mm} \pm 0.2 \text{ mm}$

The depth T of the PCB depends on the highest component used or the PCB thickness plus the descenders. The thickness of the PCB is $= 0.8 \text{ mm} \pm 10 \%$.



Note:

The dimensions (L x W x H) given in the section *Technical data* [▶ page 58] (or the identical information in the product data sheet or on the Hilscher website) are rounded figures or the respective total measure (for example, including the front panel).

8.2 Dimensions CIFS M3042100BM

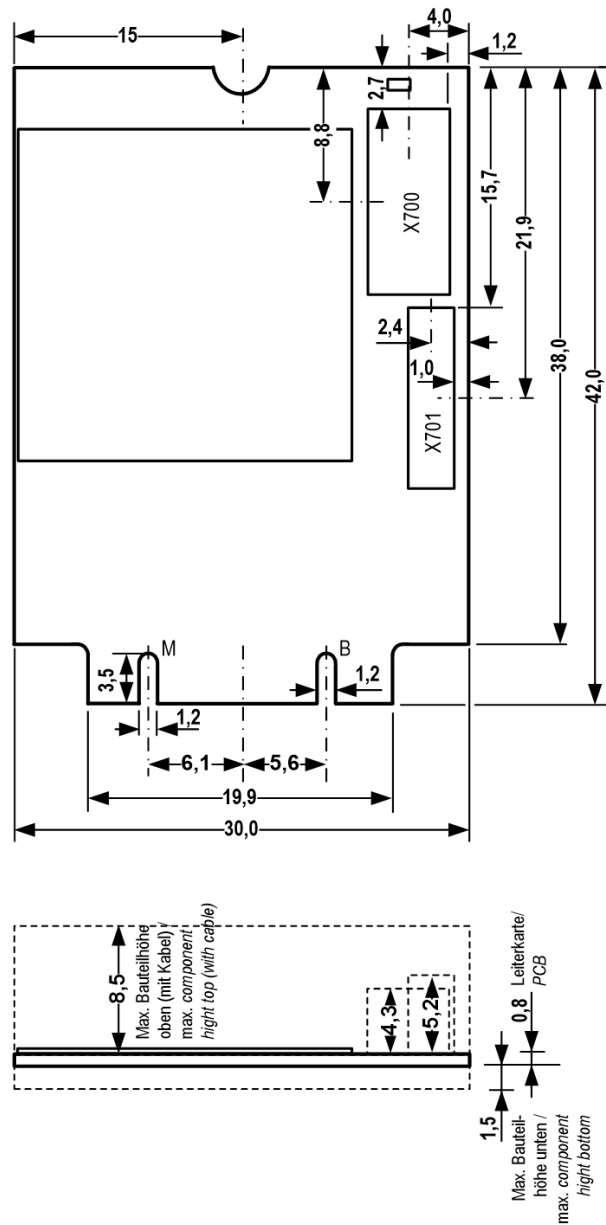

Figure 12: Dimensions CIFS M3042100BM



Note:

The height of the component on the top of the basic card M3042100BM does not meet the standard specifications. For more information, see section *System requirements* [▶ page 17].

8.3 Dimensions AIFX-RE

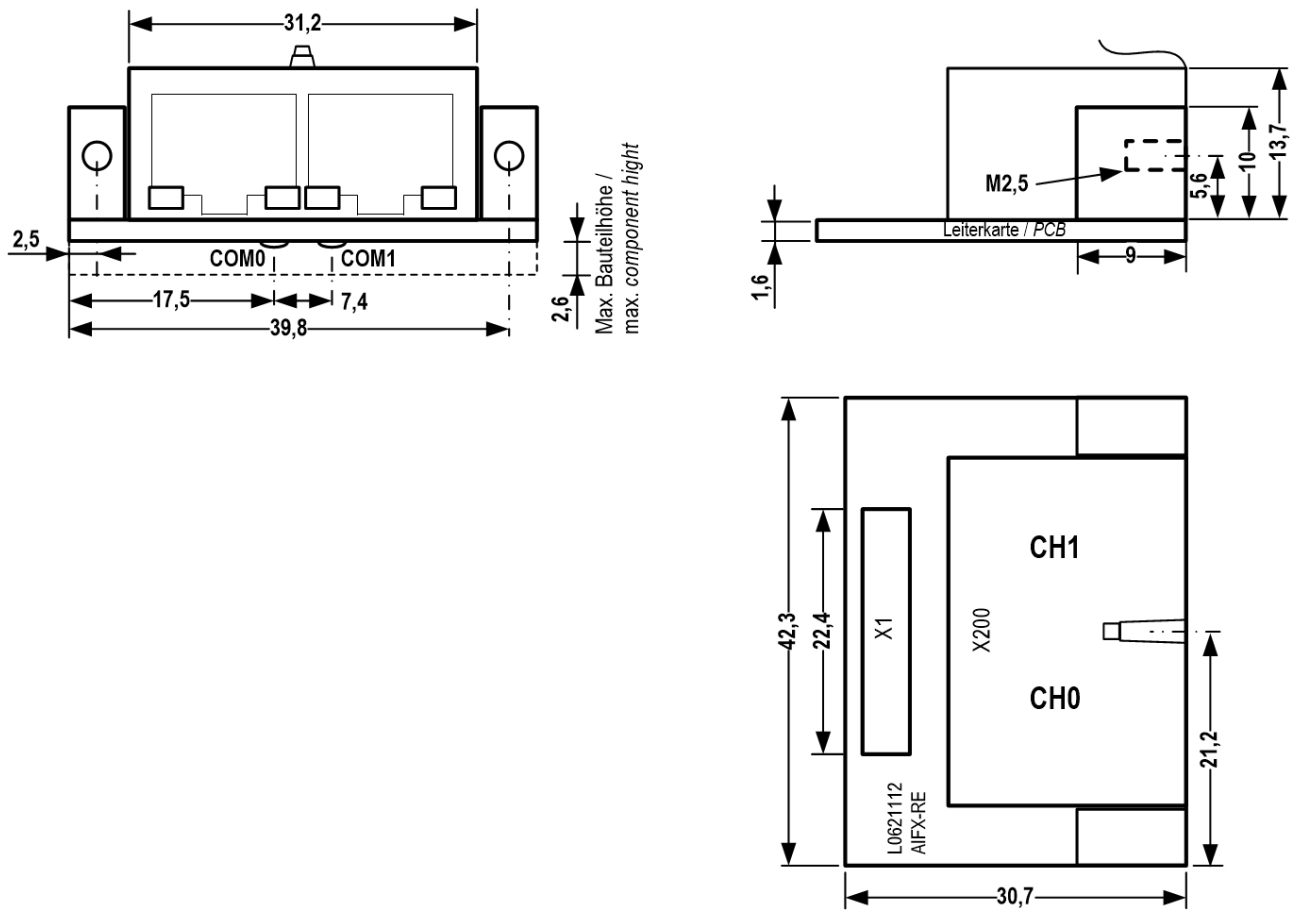

Figure 13: Dimensions AIFX-RE (Revision 2)

8.4 Dimensions AIFX-RE\M12

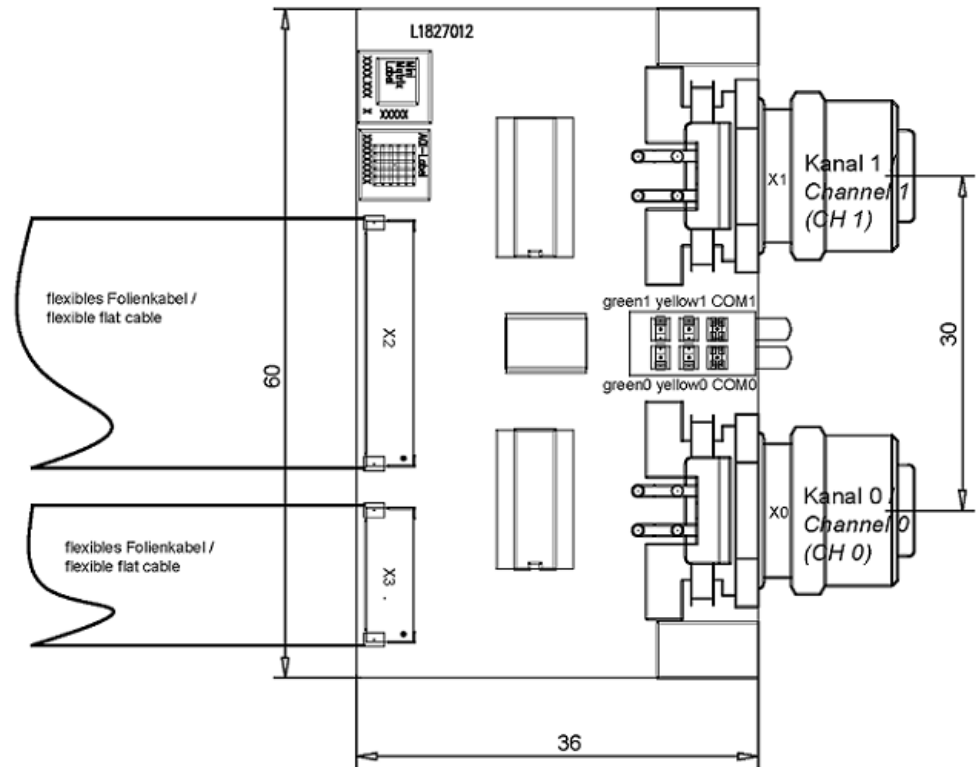
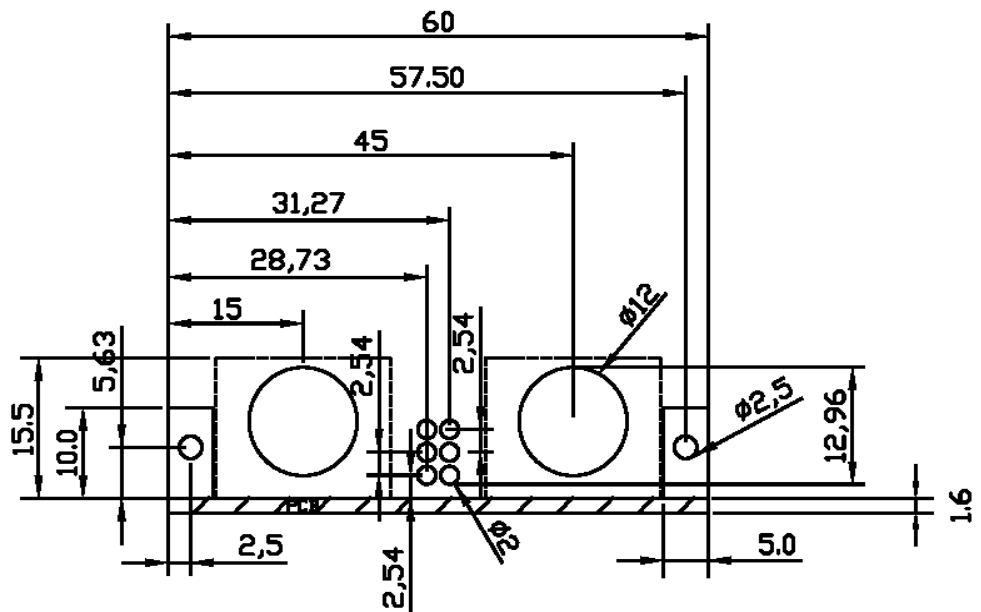

Figure 14: Dimensions AIFX-RE (Revision 2)



Drawing panel cutouts detached network interface Ethernet M12 (AIFX-RE \M12)

Panel thickness: 2-3 mm

9 Appendix

9.1 FCC compliance

Federal Communications Commission (FCC)

This device complies with part 15 of the FCC Rules. Operation is subject to the following two conditions:

1. This device may not cause harmful interference, and
2. This device must accept any interference received, including interference that may cause undesired operation.

Note: This equipment has been tested and found to comply with the limits for a Class A digital device, pursuant to part 15 of the FCC Rules. These limits are designed to provide reasonable protection against harmful interference when the equipment is operated in a commercial environment. This equipment generates, uses, and can radiate radio frequency energy and, if not installed and used in accordance with the instruction manual, may cause harmful interference to radio communications. Operation of this equipment in a residential area is likely to cause harmful interference in which case the user will be required to correct the interference at his own expense.

9.2 References

PCI Express M.2 specification

PCI-SIG (Special interest Group), PCI Express M.2 Specification, Revision 3.0, English, 2019-06

Protocol API Manuals

Hilscher Gesellschaft für Systemautomation mbH: Protocol API, CC-Link IE Field Basic Slave V1.2.0, Revision 2, DOC180402API02EN, English, 2019-09.

Hilscher Gesellschaft für Systemautomation mbH: Protocol API, EtherCAT Master V4.5.0, Revision 6, DOC150601API06EN, English, 2020-09.

Hilscher Gesellschaft für Systemautomation mbH: Protocol API, EtherCAT Slave V5.2.0, Revision 2, DOC181005API02EN, English, 2020-05.

Hilscher Gesellschaft für Systemautomation mbH: Protocol API, EtherNet/IP Scanner V2.11.0, Revision 15, DOC050702API15EN, English, 2020-10.

Hilscher Gesellschaft für Systemautomation mbH: Protocol API, EtherNet/IP Adapter V5.2.0, Revision 2, DOC190303API03EN, English, 2020-10.

Hilscher Gesellschaft für Systemautomation mbH: Protocol API, Open Modbus/TCP V3.1.0 / V5.1.0, Revision 4, DOC180702API04EN, English, 2020-06.

Hilscher Gesellschaft für Systemautomation mbH: Protocol API, Ethernet POWERLINK controlled Node, V3.5.0 / V5.1.0, Revision 10, DOC160504API10EN, English, 2021-01.

Hilscher Gesellschaft für Systemautomation mbH: Protocol API, PROFINET IO-Controller V3.4.0, Revision 8, DOC150403API08EN, English, 2021-01.

Hilscher Gesellschaft für Systemautomation mbH: Protocol API, PROFINET IO-Device V5.3.0, Revision 3, DOC190103API03EN, English, 2020-04.

Hilscher Gesellschaft für Systemautomation mbH: Protocol API, Sercos Master V2.1.0, Revision11, DOC081103API11EN, English, 2013-09.

Hilscher Gesellschaft für Systemautomation mbH: Protocol API, Sercos Slave V3.5.0, Revision17, DOC100205API17EN, English, 2017-08.

Hilscher Gesellschaft für Systemautomation mbH: Protocol API, VARAN Client (Slave) V1.0.x.x, Revision 3, DOC100613API03EN, English, 2013-10.

Design - Specification for VARAN

Design - Specification for VARAN Rev. 0.76, section 5.1.4 VARAN Splitter

Data sheet on the RJ45 femal connector

Erni electronics GmbH: Drawing, MOD JACK – MJIM, 8C8T, 1X2, INT. MAG., LED, Drawing Nr. 203311, Revision a, Schema Nr. M3D01, English, 2004-10 (<https://www.erni-x-press.com/de/downloads/zeichnungen/203313.pdf>)

Data sheet M12 socket

Data sheet 99_3732_203_04.pdf (product data sheet of the company binder): <https://www.binder-connector.com>

Documentation on drivers and software

Hilscher Gesellschaft für Systemautomation mbH: User manual, PC cards CIFX M3042100BM-RE\F, Hardware description and installation, DOC210301UMxxEN, English, 2021-04.

Hilscher Gesellschaft für Systemautomation mbH: User manual, Installation of the software for PC cards cifX, Installing drivers and configuration software, DOC120207UMxxEN, English, 2017-04.

Hilscher Gesellschaft für Systemautomation mbH: Operating instruction manual, SYCON.net netFrame, Frame application, DOC040402OIxxEN, English, 2018-03.

Hilscher Gesellschaft für Systemautomation mbH: Operating instruction manual, netDevice und netProject, FDT-Container, DOC040401OIxxEN, English, 2018-03.

Hilscher Gesellschaft für Systemautomation mbH: Operating instruction manual, DTM for Hilscher CC-Link IE Field Basic Slave devices, Configuration of Hilscher Slave devices, DOC180604OIxxEN, English, 2020-01.

Hilscher Gesellschaft für Systemautomation mbH: Operating instruction manual, DTM for EtherCAT Master devices, Configuration of Hilscher Master devices, DOC080404OIxxEN, English, 2018-03

Hilscher Gesellschaft für Systemautomation mbH: Operating instruction manual, DTM for Hilscher EtherCAT Slave devices, Configuration of Hilscher Slave devices, DOC110702OIxxEN, English, 2020-01.

Hilscher Gesellschaft für Systemautomation mbH: Operating instruction manual, Generic DTM for EtherCAT Slave devices, Configuration of EtherCAT Slave devices, DOC071202OIxxEN, English, 2018-03.

Hilscher Gesellschaft für Systemautomation mbH: Operating instruction manual, DTM for Ethernet/IP Scanner devices, Configuration of Ethernet/IP Scanner devices, DOC061201OIxxEN, English, 2018-03.

Hilscher Gesellschaft für Systemautomation mbH: Operating instruction manual, DTM for Ethernet/IP Adapter devices, Configuration of Ethernet/IP Adapter devices, DOC061202OIxxEN, English, 2020-01.

Hilscher Gesellschaft für Systemautomation mbH: Operating instruction manual, Generic, Modular Generic DTM from EDS file for non-modular and modular Ethernet/IP adapter devices, Configuration of Ethernet/IP adapter devices, DOC070203OIxxEN, English, 2018-03.

Hilscher Gesellschaft für Systemautomation mbH: Operating instruction manual, DTM for Hilscher-Open Modbus/TCP devices, Configuration of Hilscher-Open Modbus/TCP devices, DOC2004xxOlxEN, English, 2020-02.

Hilscher Gesellschaft für Systemautomation mbH: Operating instruction manual, netSLAVE DTM for Hilscher netX Slave devices, Configuration of Hilscher Slave devices, DOC0808xxOlxEN, English, 2020-03.

Hilscher Gesellschaft für Systemautomation mbH: Operating instruction manual, DTM for PROFINET IO Controller devices, Configuration of Hilscher Controller devices, DOC150704OlxEN, English, 2019-04.

Hilscher Gesellschaft für Systemautomation mbH: Operating instruction manual, DTM for Hilscher-PROFINET IO-Device devices, Configuration of Hilscher-Device devices, DOC060303OlxEN, English, 2020-01.

Hilscher Gesellschaft für Systemautomation mbH: Operating instruction manual, Generic DTM for PROFINET IO Device devices, Configuration of PROFINET IO Device devices, DOC060305OlxEN, English, 2018-04.

Hilscher Gesellschaft für Systemautomation mbH: Operating instruction manual, DTM for Sercos Master devices, Configuration of Hilscher-Master-devices, DOC090301OlxEN, English, 2018-04.

Hilscher Gesellschaft für Systemautomation mbH: Operating instruction manual, Generic DTM for Sercos Slave devices, Configuration of Sercos Slave devices, DOC090302OlxEN, English, 2018-04.

Hilscher Gesellschaft für Systemautomation mbH: Operating instruction manual, cifX Device Driver, Installation and operation for Windows XP/ Vista/7/8/10, DOC060601OlxEN, English, 2019-01.

Hilscher Gesellschaft für Systemautomation mbH: Dual-Port Memory Interface Manual, netX Dual-Port Memory Interface, DOC060302DPMxxEN, English, 2020-06.

Safety standards

American National Standards Institute, Inc.: American National Standard, Product Safety Information in Product Manuals, Instructions, and Other Collateral Materials, ANSI Z535.6-2016, English, 2016.

DIN Deutsches Institut für Normung e. v. and VDE Verband der Elektrotechnik Elektronik Informationstechnik e. V.: German standard, Equipment for audio/video, information and communication technology - Part 1: Safety requirements, (IEC 62368-1:2014, modified + Cor.:2015); English version EN 62368-1:2014 + AC:2015, English, 2016-05.

DIN Deutsches Institut für Normung e. v. and VDE Verband der Elektrotechnik Elektronik Informationstechnik e. V.: German standard, Electrostatics - Part 5-1: Protection of electronic components against electrostatic phenomena, General requirements, (IEC 61340-5-1:2016); English version EN 61340-5-1:2016, English, 2017-07.

DIN Deutsches Institut für Normung e. v. und VDE Verband der Elektrotechnik Elektronik Informationstechnik e. V.: German standard, Electrostatics - Part 5-2: Protection of electronic components against electrostatic phenomena, User manual, (IEC TR 61340-5-2:2018), DIN IEC/ TR 61340-5-2 (VDE V 0300-5-2), English, 2019-04.

9.3 Conventions in this manual

Instructions for action and results

1. Operate purpose
2. Operate purpose
 - Instructions for action
 - Intermediate result
 - ⇒ Final result

Signs and signal words









Sign	Description	Sign	Description
	General note		Important note that must be followed to prevent malfunctions
	Reference on further information (acc. to ISO 7010 M001)		Disconnect the power plug (acc. to ISO 7010 M006)
	Warning of Personal Injury and Property Damage Message (acc. to ISO 7010 W001) USA: Warning of Personal Injury As in the scope of the ANSI Z535 Standard (for USA) instructions to a property damage message may not contain a warning triangle, this property damage messages are listed separately for the USA.		
	Warning of hazardous voltage! (acc. to ISO 7010 W012) Danger to life, risk of injury by electric shock		
	USA: Warning of hazardous voltage! (acc. to ANSI Z535.4) Danger to life, risk of injury by electric shock		
	Warning of damage due to electrostatic discharge (acc. to IEC 60417-5134)		

Table 89: Signs

Signal word	Description
DANGER	Indicates a hazardous situation, which if not avoided, will result in death or serious injury.
WARNING	Indicates a hazardous situation, which if not avoided, could result in death or serious injury.
CAUTION	Indicates a hazardous situation, which if not avoided, may result in minor or moderate Injury.
NOTICE	Indicates a property damage message.

Table 90: Signal words

9.4 Legal notes

Copyright

© Hilscher Gesellschaft für Systemautomation mbH

All rights reserved.

The images, photographs and texts in the accompanying materials (in the form of a user's manual, operator's manual, Statement of Work document and all other document types, support texts, documentation, etc.) are protected by German and international copyright and by international trade and protective provisions. Without the prior written consent, you do not have permission to duplicate them either in full or in part using technical or mechanical methods (print, photocopy or any other method), to edit them using electronic systems or to transfer them. You are not permitted to make changes to copyright notices, markings, trademarks or ownership declarations. Illustrations are provided without taking the patent situation into account. Any company names and product designations provided in this document may be brands or trademarks by the corresponding owner and may be protected under trademark, brand or patent law. Any form of further use shall require the express consent from the relevant owner of the rights.

Important notes

Utmost care was/is given in the preparation of the documentation at hand consisting of a user's manual, operating manual and any other document type and accompanying texts. However, errors cannot be ruled out. Therefore, we cannot assume any guarantee or legal responsibility for erroneous information or liability of any kind. You are hereby made aware that descriptions found in the user's manual, the accompanying texts and the documentation neither represent a guarantee nor any indication on proper use as stipulated in the agreement or a promised attribute. It cannot be ruled out that the user's manual, the accompanying texts and the documentation do not completely match the described attributes, standards or any other data for the delivered product. A warranty or guarantee with respect to the correctness or accuracy of the information is not assumed.

We reserve the right to modify our products and the specifications for such as well as the corresponding documentation in the form of a user's manual, operating manual and/or any other document types and accompanying texts at any time and without notice without being required to notify of said modification. Changes shall be taken into account in future manuals and do not represent an obligation of any kind, in particular there shall be no right to have delivered documents revised. The manual delivered with the product shall apply.

Under no circumstances shall Hilscher Gesellschaft für Systemautomation mbH be liable for direct, indirect, ancillary or subsequent damage, or for any loss of income, which may arise after use of the information contained herein.

Liability disclaimer

The hardware and/or software was created and tested by Hilscher Gesellschaft für Systemautomation mbH with utmost care and is made available as is. No warranty can be assumed for the performance or flawlessness of the hardware and/or software under all application conditions and scenarios and the work results achieved by the user when using the hardware and/or software. Liability for any damage that may have occurred as a result of using the hardware and/or software or the corresponding documents shall be limited to an event involving willful intent or a grossly negligent violation of a fundamental contractual obligation. However, the right to assert damages due to a violation of a fundamental contractual obligation shall be limited to contract-typical foreseeable damage.

It is hereby expressly agreed upon in particular that any use or utilization of the hardware and/or software in connection with

- Flight control systems in aviation and aerospace;
- Nuclear fission processes in nuclear power plants;
- Medical devices used for life support and
- Vehicle control systems used in passenger transport

shall be excluded. Use of the hardware and/or software in any of the following areas is strictly prohibited:

- For military purposes or in weaponry;
- For designing, engineering, maintaining or operating nuclear systems;
- In flight safety systems, aviation and flight telecommunications systems;
- In life-support systems;
- In systems in which any malfunction in the hardware and/or software may result in physical injuries or fatalities.

You are hereby made aware that the hardware and/or software was not created for use in hazardous environments, which require fail-safe control mechanisms. Use of the hardware and/or software in this kind of environment shall be at your own risk; any liability for damage or loss due to impermissible use shall be excluded.

Warranty

Hilscher Gesellschaft für Systemautomation mbH hereby guarantees that the software shall run without errors in accordance with the requirements listed in the specifications and that there were no defects on the date of acceptance. The warranty period shall be 12 months commencing as of the date of acceptance or purchase (with express declaration or implied, by customer's conclusive behavior, e.g. putting into operation permanently).

The warranty obligation for equipment (hardware) we produce is 36 months, calculated as of the date of delivery ex works. The aforementioned provisions shall not apply if longer warranty periods are mandatory by law pursuant to Section 438 (1.2) BGB, Section 479 (1) BGB and Section 634a (1) BGB [Bürgerliches Gesetzbuch; German Civil Code] If, despite of all due care taken, the delivered product should have a defect, which already existed at the time of the transfer of risk, it shall be at our discretion to either repair the product or to deliver a replacement product, subject to timely notification of defect.

The warranty obligation shall not apply if the notification of defect is not asserted promptly, if the purchaser or third party has tampered with the products, if the defect is the result of natural wear, was caused by unfavorable operating conditions or is due to violations against our operating regulations or against rules of good electrical engineering practice, or if our request to return the defective object is not promptly complied with.

Costs of support, maintenance, customization and product care

Please be advised that any subsequent improvement shall only be free of charge if a defect is found. Any form of technical support, maintenance and customization is not a warranty service, but instead shall be charged extra.

Additional guarantees

Although the hardware and software was developed and tested in-depth with greatest care, Hilscher Gesellschaft für Systemautomation mbH shall not assume any guarantee for the suitability thereof for any purpose that was not confirmed in writing. No guarantee can be granted whereby the hardware and software satisfies your requirements, or the use of the hardware and/or software is uninterrupted or the hardware and/or software is fault-free.

It cannot be guaranteed that patents and/or ownership privileges have not been infringed upon or violated or that the products are free from third-party influence. No additional guarantees or promises shall be made as to whether the product is market current, free from deficiency in title, or can be integrated or is usable for specific purposes, unless such guarantees or promises are required under existing law and cannot be restricted.

Confidentiality

The customer hereby expressly acknowledges that this document contains trade secrets, information protected by copyright and other patent and ownership privileges as well as any related rights of Hilscher Gesellschaft für Systemautomation mbH. The customer agrees to treat as confidential all of the information made available to customer by Hilscher Gesellschaft für Systemautomation mbH and rights, which were disclosed by Hilscher Gesellschaft für Systemautomation mbH and that were made accessible as well as the terms and conditions of this agreement itself.

The parties hereby agree to one another that the information that each party receives from the other party respectively is and shall remain the intellectual property of said other party, unless provided for otherwise in a contractual agreement.

The customer must not allow any third party to become knowledgeable of this expertise and shall only provide knowledge thereof to authorized users as appropriate and necessary. Companies associated with the customer shall not be deemed third parties. The customer must obligate authorized users to confidentiality. The customer should only use the confidential information in connection with the performances specified in this agreement.

The customer must not use this confidential information to his own advantage or for his own purposes or rather to the advantage or for the purpose of a third party, nor must it be used for commercial purposes and this confidential information must only be used to the extent provided for in this agreement or otherwise to the extent as expressly authorized by the disclosing party in written form. The customer has the right, subject to the obligation to confidentiality, to disclose the terms and conditions of this agreement directly to his legal and financial consultants as would be required for the customer's normal business operation.

Export provisions

The delivered product (including technical data) is subject to the legal export and/or import laws as well as any associated regulations of various countries, especially such laws applicable in Germany and in the United States. The products / hardware / software must not be exported into such countries for which export is prohibited under US American export control laws and its supplementary provisions. You hereby agree to strictly follow the regulations and to yourself be responsible for observing them. You are hereby made aware that you may be required to obtain governmental approval to export, reexport or import the product.

9.5 Registered trademarks

Windows® 10 is a registered trademark of the Microsoft Corporation.

Adobe-Acrobat® is a registered trademark of the Adobe Systems Incorporated.

CC-Link IE® is a registered trademark of Mitsubishi Electric Corporation, Tokyo, Japan.

EtherCAT® is a registered trademark and patented technology, licensed by Beckhoff Automation GmbH, Germany.

EtherNet/IP™ is a trademark of the ODVA (Open DeviceNet Vendor Association, Inc.).

Modbus is a registered trademark of Schneider Electric.

POWERLINK is a registered trademark of B&R, Bernecker + Rainer Industrie-Elektronik Ges.m.b.H, Eggelsberg, Austria.

PROFINET® is a registered trademark of PROFIBUS & PROFINET International (PI), Karlsruhe.

Sercos® and Sercos® interface are registered trademarks of Sercos International e. V., Süssen, Germany.

PCI Express® and PCIe® are trademarks or registered trademarks of the Peripheral Component Interconnect Special Interest Group (PCI-SIG).

All other brands mentioned are property of their respective owner of the rights. Any company names and product designations provided in this document may be brands (company names or trademarks) of the corresponding owner and may be protected under trademark or patent law.

9.6 Licenses

Bei Verwendung der jeweiligen PC-Karte cifX als Slave, ist für die Firmware als auch für die Konfigurationssoftware SYCON.net keine Lizenz erforderlich.

Lizenzen sind notwendig, wenn die PC-Karte cifX mit

- einer Firmware mit Master-Funktionalität*.

verwendet wird.

* Die Master-Lizenz beinhaltet den Betrieb der PC-Karte cifX als Master sowie die Lizenz für die Konfigurationssoftware SYCON.net für das jeweilige cifX.

List of figures

Figure 1:	Basic card CIFX M3042100BM	7
Figure 2:	Detached network interface AIFX-RE (RJ45, Revision 3)	8
Figure 3:	Detached network interface AIFX-RE\M12 (Revision 2)	9
Figure 4:	Example 2D label	12
Figure 5:	Connecting cable to the detached network interface Ethernet AIFX-RE	24
Figure 6:	Connecting cable to the detached network interface Ethernet AIFX-RE\M12	24
Figure 7:	Connecting cable to the basic card, example CIFX M3042100BM	24
Figure 8:	Ethernet pin assignment at the RJ45 socket	50
Figure 9:	Cable connector Ethernet X1; 1x20 pins, AIFX-RE	53
Figure 10:	Cable connector Ethernet X2; 1x20 pins, AIFX-RE\M12	54
Figure 11:	Cable connector LED signals X3; 1x10 pins, AIFX-RE\M12	55
Figure 12:	Dimensions CIFX M3042100BM	77
Figure 13:	Dimensions AIFX-RE (Revision 2)	78
Figure 14:	Dimensions AIFX-RE (Revision 2)	79

List of tables

Table 1:	List of revisions	5
Table 2:	PC card cifX	6
Table 3:	Meaning of the device name.....	6
Table 4:	Legend for the basic card CIFX M3042100BM.....	7
Table 5:	Legend for the detached network interface AIFX-RE	8
Table 6:	Legend for the detached network interface AIFX-REIM12	9
Table 7:	Hardware revisions	11
Table 8:	Versions for drivers and software	11
Table 9:	Firmware version and file names for permitted protocols	11
Table 10:	Host interface requirements.....	17
Table 11:	Panel cut-outs and holes for mounting AIFX	18
Table 12:	Requirements for operation	19
Table 13:	Overview for installation and firmware download	20
Table 14:	Behavior of the communication status LEDs in the “in operation” status	25
Table 15:	LEDs Real-Time Ethernet systems (duo LEDs and Ethernet LEDs).....	29
Table 16:	LED designations.....	29
Table 17:	States of the SYS LED, netX 10/50/51/52/100/500-based devices.....	30
Table 18:	LED states for the CC-Link IE Field Basic slave.....	31
Table 19:	LED state definitions for theCC-Link IE Field Basic slave protocol	31
Table 20:	Communication status EtherCAT Master (V4).....	32
Table 21:	Definition of the LED states communication status	32
Table 22:	Ethernet status EtherCAT Master (V4).....	33
Table 23:	Definition of the LED state Ethernet status.....	33
Table 24:	Communication status EtherCAT Slave	34
Table 25:	Definition LED states communication status	34
Table 26:	Ethernet status EtherCAT Slave	34
Table 27:	Definition LED states Ethernet status	35
Table 28:	Communication status EtherNet/IP Scanner	35
Table 29:	Definition of the LED states communication status	36
Table 30:	Ethernet status EtherNet/IP Scanner.....	36
Table 31:	Definition of the LED state Ethernet status.....	36
Table 32:	Communication status EtherNet/IP Adapter	37
Table 33:	Definition LED states communication status	38
Table 34:	Ethernet status EtherNet/IP Adapter	38
Table 35:	Definition LED states Ethernet status	38
Table 36:	Communication status OpenModbusTCP	39
Table 37:	Definition LED states communication status	39
Table 38:	Ethernet status OpenModbusTCP	39
Table 39:	Definition LED states Ethernet status	39
Table 40:	Communication status POWERLINK Controlled Node.....	40

Table 41:	Definition of LED states communication status	40
Table 42:	Ethernet status POWERLINK Controlled Node	41
Table 43:	Definition of LED state Ethernet status	41
Table 44:	System and communication status PROFINET IO-Controller	42
Table 45:	Definition of the LED states communication status	42
Table 46:	Ethernet status PROFINET IO-Controller	43
Table 47:	Definition of the LED state Ethernet status	43
Table 48:	Communication status PROFINET IO-Device	44
Table 49:	Definition LED states communication status	44
Table 50:	Ethernet status PROFINET IO-Device	44
Table 51:	Definition LED states Ethernet status	44
Table 52:	Communication status Sercos Master	45
Table 53:	Definition of the LED states communication status	45
Table 54:	Ethernet status Sercos Master	46
Table 55:	Definition of the LED state Ethernet status	46
Table 56:	Communication status Sercos Slave	47
Table 57:	Definition of the LED states communication status	47
Table 58:	Ethernet status Sercos Slave	48
Table 59:	Definition of the LED state Ethernet status	48
Table 60:	Communication status VARAN Client.....	49
Table 61:	Definition of the LED states communication status	49
Table 62:	Ethernet status VARAN Client	49
Table 63:	Definition of the LED state Ethernet status	49
Table 64:	Ethernet pin assignment at the RJ45 socket	50
Table 65:	Ethernet	51
Table 66:	Ethernet connection data 100BASE-TX and 10BASE-T	51
Table 67:	Usability of hubs and switches.....	52
Table 68:	Pin assignment for cable connector Ethernet X700 (BM20B-SRDS-G-T), on CIFX M3042100BM	52
Table 69:	Pin assignment for cable connector Ethernet X1, AIFX-RE	53
Table 70:	Pin assignment for cable connector Ethernet X2, AIFX-RE\M12	54
Table 71:	Pin assignment for cable connector LED signals X3, AIFX-RE\M12	55
Table 72:	Pin assignment PCI Express M.2 bus X200, CIFX M3042100BM	56
Table 73:	Technical data CIFX M3042100BM-RE\F	58
Table 74:	PCI identifier on the PCI Express M.2 bus for CIFX M3042100BM.....	59
Table 75:	Technical data AIFX-RE	60
Table 76:	Technical data AIFX-RE	61
Table 77:	Technical data CC-Link IE Field Basic Slave	62
Table 78:	Technical data EtherCAT Master.....	63
Table 79:	Techncal data EtherCAT Slave	64
Table 80:	Technical data EtherNet/IP Scanner	66
Table 81:	Technical data EtherNet/IP Adapter	67

Table 82:	Technical data Open Modbus/TCP.....	68
Table 83:	POWERLINK Controlled Node	68
Table 84:	Technical data PROFINET IO-Controller.....	69
Table 85:	Technical data PROFINET IO-Device	71
Table 86:	Technical data Sercos Master	73
Table 87:	Technical data Sercos Slave	74
Table 88:	Technical data VARAN Client.....	75
Table 89:	Signs	85
Table 90:	Signal words	85

Glossary

100BASE-TX	Standard for communication on Ethernet over unshielded twisted pair lines with RJ45 connectors and a Baud_rate of 100 MBit/s (according to the IEEE 802. specification)
10BASE-T	Standard for communication on Ethernet over twisted pair lines with RJ45 connectors and a Baud_rate of 10 MBit/s (according to the IEEE 802.3 specification).
Auto crossover	Auto crossover is a feature of interfaces. An interface with auto-crossover functionality automatically detects and corrects if the data lines are reversed.
CC-Link IE Field Basic	Communication system for Industrial Ethernet designed and developed by Mitsubishi Electric Corporation, Tokyo, Japan, providing CC-Link IE Field with a speed of 100 Mbit/s based on TCP/IP
CC-Link IE Field Basic Slave	Station in the CC-Link IE Field Basic network communicating with a master station
cifX	Communication InterFace based on netX
CIFX M3042100BM	Communication interface in M.2 format and B+M key from Hilscher on the basis of the netX 100 communication controller
Communication phase	During getting operational, a Sercos device runs through various phases (NRT, CP0 – CP4). These are called communication phases (CP).
DCP	Discovery and basic configuration protocol: Protocol for identifying and configuring devices, which is defined within the PROFINET specification
DPM	Dual-port memory
EtherCAT	Ethernet for Control Automation Technology: communication system for Industrial Ethernet designed and developed by Beckhoff Automation GmbH, Verl, Germany
EtherCAT Master	Device responsible for configuration and parameterization of: an EtherCAT segment, the controllers of all devices within this segment and all services for cyclic process data exchange, mailbox operation and diagnosis
EtherCAT Slave	Device which is configured by the EtherCAT master, receives data telegrams containing output data, executes commands issued by the EtherCAT master and provides input and status data
EtherNet/IP	Communication system for industrial Ethernet designed and developed by Rockwell that uses the CIP (common industrial protocol)
EtherNet/IP Adapter	Exchanges real-time I/O data with a Scanner Class product and does not initiate connections on its own
EtherNet/IP Scanner	Exchanges real-time I/O data with adapters and scanners, can respond to connection requests and also initiate connections on its own

Full duplex	Telecommunication system between two partners that enables simultaneous communication in both directions. In such a system, data can be sent even when data is being received simultaneously.
Half duplex	Telecommunication system between two partners that does not allow simultaneous, but only alternating communication in both directions. In such a system, receiving data inhibits the possibility of sending data simultaneously.
Hub	Network component connecting multiple communication partners with each other, but does not provide own intelligence, thus it does not
IP	Internet Protocol: Belongs to the TCP/IP family of protocols and is defined in RFC791 (available on http://www.ietf.org/rfc/rfc791.txt). It is based on layer 3 of the ISO/OSI 7 layer model of networking and is a connectionless protocol, i. e. you do not need to open a connection to a computer before sending an IP data packet to it. Therefore, IP is not able to guarantee that the IP data packets really arrive at the recipient. On IP level, neither the correctness of data nor the consistence and completeness are checked. IP defines special addressing mechanisms; see IP address.
IP address	Identifies a device or a computer within an IP-based network and is defined in the Internet Protocol Version 4 (IPv4) as a 32-bit number. For ease of notation, the address is usually divided into four 8-bit numbers represented in decimal notation and separated by points: a.b.c.d. Each letter stands for an integer value between 0 and 255, e.g. 192.168.30.16. However, not all combinations are allowed, some are reserved for special purposes. The IP address 0.0.0.0 is defined as invalid.
Master	Type of device that initiates and controls the communication on the bus
netX	networX on chip, Hilscher network communication controller. High integrated network controller with optimized system architecture for communication and maximum data transfer.
Open Modbus/TCP	Communication system for Industrial Ethernet designed and developed by Schneider Automation and maintained by the Modbus-IDA organization based on the Modbus protocols for serial communication
POWERLINK	Communication system for industrial Ethernet designed and developed by B&R which also uses CANopen technologies
PROFINET	Communication system for Industrial Ethernet, designed and developed by PROFIBUS & PROFINET International (PI), which uses some mechanisms similar to those of the PROFIBUS field bus
PROFINET IO	PROFINET IO (Input - Output) has been created for the connection of remote peripheral to a controller
PROFINET IO-Controller	PROFINET control unit responsible for the defined run-up of an I/O subsystem and the cyclic or acyclic data exchange
PROFINET IO-Device	PROFINET field device that cyclically receives output data from its IO-Controller and responds with its input data

Real-Time Ethernet	Extension of the Ethernet networking technology for industrial purposes with very good Real-Time features and performance also named as 'Industrial Ethernet'. There is a variety of different Real-Time Ethernet systems on the market, which are incompatible with each other. The most important systems are: EtherCAT, EtherNet/IP, POWERLINK, Open Modbus/TCP, PROFINET, Sercos, VARAN.
RJ45	A connector type often used for Ethernet connection. It has been standardized by the Federal Communications Commission of the USA (FCC).
Sercos	Communication system for industrial Ethernet designed and developed by Bosch-Rexroth and supported by Sercos International e. V.
Sercos Master	Device that initiates the data transfer on the bus and which is an active network node, that is authorized and able to send data without external request
Sercos Slave	Peripheral device, such as a IO device or a drive respectively passive participant without bus access authorization, which may only acknowledge received messages or requested by a master, may transmit messages to this one
Slave	Type of device that is configured by the master and which then performs the communication
Switch	Intelligent network component connecting multiple communication partners (or even entire branches of a network) with each other, capable to analyze the network traffic in order to decide on its own and shows transparent behaviour to connected communication partners
SYNC	Synchronisation Cycle of the Master
VARAN	Versatile Automation Random Access Network: communication system for industrial Ethernet based on the DIAS-BUS developed by Sigmatek; supported by the VARAN-BUS-NUTZERORGANISATION (VNO)

Contacts

HEADQUARTER

Germany

Hilscher Gesellschaft für
Systemautomation mbH
Rheinstraße 15
65795 Hattersheim
Phone: +49 (0) 6190 9907-0
Fax: +49 (0) 6190 9907-50
E-mail: info@hilscher.com

Support

Phone: +49 (0) 6190 9907-990
E-mail: hotline@hilscher.com

SUBSIDIARIES

China

Hilscher Systemautomation (Shanghai) Co. Ltd.
200010 Shanghai
Phone: +86 (0) 21-6355-5161
E-mail: info@hilscher.cn

Support

Phone: +86 (0) 21-6355-5161
E-mail: cn.support@hilscher.com

France

Hilscher France S.a.r.l.
69800 Saint Priest
Phone: +33 (0) 4 72 37 98 40
E-mail: info@hilscher.fr

Support

Phone: +33 (0) 4 72 37 98 40
E-mail: fr.support@hilscher.com

India

Hilscher India Pvt. Ltd.
Pune, Delhi, Mumbai, Bangalore
Phone: +91 8888 750 777
E-mail: info@hilscher.in

Support

Phone: +91 8108884011
E-mail: info@hilscher.in

Italy

Hilscher Italia S.r.l.
20090 Vimodrone (MI)
Phone: +39 02 25007068
E-mail: info@hilscher.it

Support

Phone: +39 02 25007068
E-mail: it.support@hilscher.com

Japan

Hilscher Japan KK
Tokyo, 160-0022
Phone: +81 (0) 3-5362-0521
E-mail: info@hilscher.jp

Support

Phone: +81 (0) 3-5362-0521
E-mail: jp.support@hilscher.com

Republic of Korea

Hilscher Korea Inc.
13494, Seongnam, Gyeonggi
Phone: +82 (0) 31-739-8361
E-mail: info@hilscher.kr

Support

Phone: +82 (0) 31-739-8363
E-mail: kr.support@hilscher.com

Austria

Hilscher Austria GmbH
4020 Linz
Phone: +43 732 931 675-0
E-mail: sales.at@hilscher.com

Support

Phone: +43 732 931 675-0
E-mail: at.support@hilscher.com

Switzerland

Hilscher Swiss GmbH
4500 Solothurn
Phone: +41 (0) 32 623 6633
E-mail: info@hilscher.ch

Support

Phone: +41 (0) 32 623 6633
E-mail: support.swiss@hilscher.com

USA

Hilscher North America, Inc.
Lisle, IL 60532
Phone: +1 630-505-5301
E-mail: info@hilscher.us

Support

Phone: +1 630-505-5301
E-mail: us.support@hilscher.com