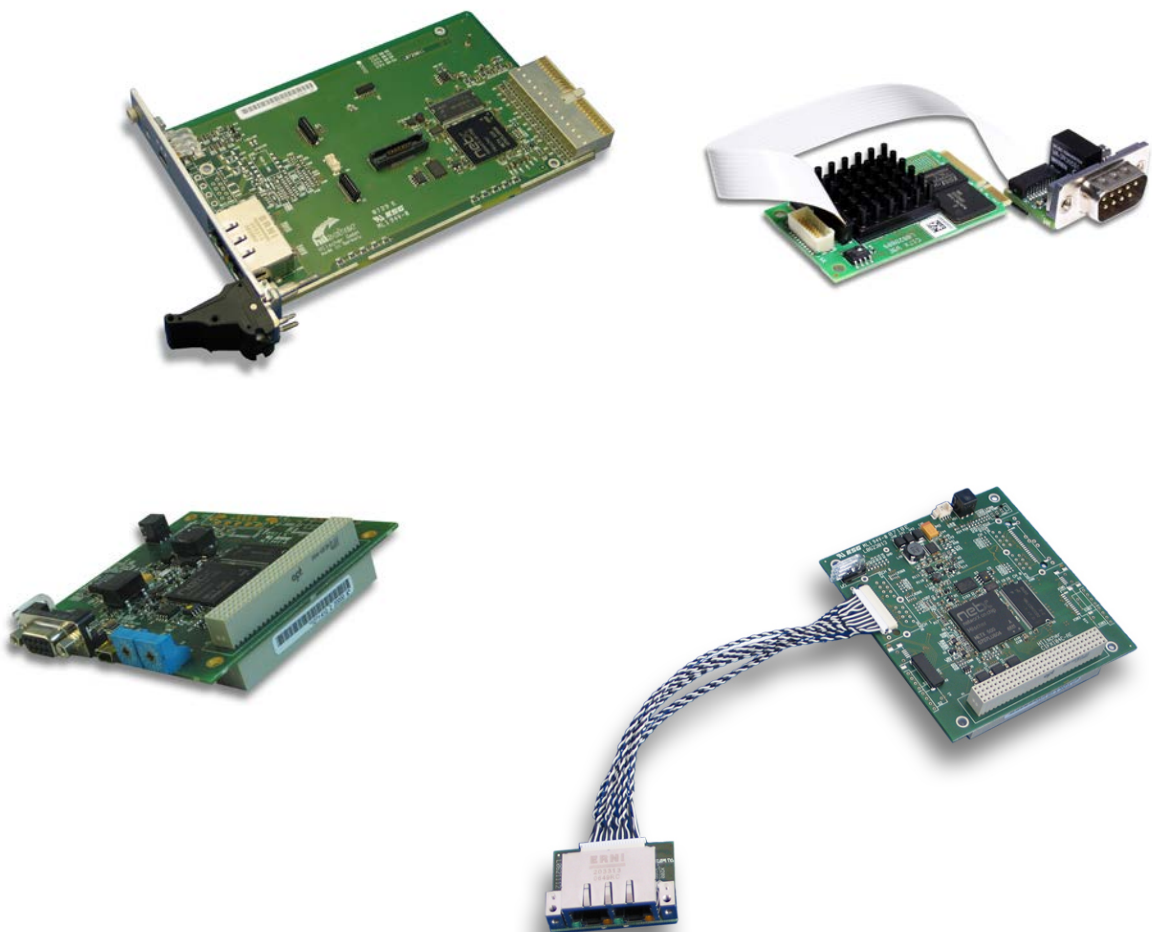

User Manual**PC Cards cifX****Compact PCI (CIFX 80)****Mini PCI (CIFX 90)****Mini PCI Express (CIFX 90E)****PCI-104 (CIFX 104C)****Installation, Operation and Hardware Description****Hilscher Gesellschaft für Systemautomation mbH****www.hilscher.com**

DOC120205UM57EN | Revision 57 | English | 2023-04 | Released | Public

Table of Contents

1	INTRODUCTION.....	9
1.1	About the User Manual.....	9
1.2	List of Revisions.....	10
1.3	Obligation to read and understand the Manual.....	10
2	DESCRIPTIONS OF THE PC CARDS.....	11
2.1	Description.....	11
2.2	PC Cards cifX with integrated Interfaces.....	12
2.2.1	PC Cards Compact PCI CIFX 80-XX.....	12
2.2.2	PC Cards PCI-104: CIFX 104C-XX and CIFX 104C-XX-R.....	12
2.3	PC Cards cifX with detached Network Interface AIFX.....	13
2.3.1	The Label „\F“ in the Device Name.....	13
2.3.2	PC Cards Mini PCI CIFX 90-XX\F and Variant.....	14
2.3.3	PC Cards Mini PCI Express CIFX 90E-XX\F and Variant.....	15
2.3.4	PC Cards Mini PCI Express CIFX 90E-XX\NHS\F and Variant.....	16
2.3.5	PC Cards Mini PCI Express CIFX 90E-XX\ET\F and Variant.....	17
2.3.6	PC Cards Mini PCI Express CIFX 90E-XX\MR\F and Variant.....	18
2.3.7	PC Cards Mini PCI Express CIFX 90E-XX\MR\ET\F and Variant.....	19
2.3.8	PC Cards Mini PCI Express (2 Channels) CIFX 90E-2XX\ET\F, CIFX 90E-2XX\XX\ET\F.....	20
2.3.9	PC Cards Mini PCI Express (2 Channels) CIFX 90E-2XX\MR\ET\F, CIFX 90E-2XX\XX\MR\ET\F.....	21
2.3.10	PC Cards PCI-104: CIFX 104C-XX\F, CIFX 104C-XX-R\F and Variants.....	22
2.3.11	Detached Network Interfaces AIFX.....	23
2.4	The Function „DMA Mode“.....	24
2.5	PC Cards cifX with additional MRAM.....	24
2.6	Contents of the Product DVD.....	25
2.6.1	Installation Guide, Documentation Overview.....	25
2.6.2	What's New.....	25
2.6.3	Important Changes.....	25
2.6.4	Device Description Files cifX.....	26
2.7	Revision or version status of hardware and software.....	28
2.7.1	Hardware: PC Cards cifX.....	28
2.7.2	Hardware: Product Components for PC Cards cifX.....	30
2.7.3	Firmware.....	31
2.7.4	Driver and Software.....	32
2.8	Device Label with Matrix or Bar Code.....	33
3	DEVICE DRAWINGS.....	34
3.1	PC Cards cifX Compact PCI.....	34
3.1.1	CIFX 80-RE.....	34
3.1.2	CIFX 80-DP.....	35

3.1.3	CIFX 80-CO	36
3.1.4	CIFX 80-DN	37
3.2	PC Cards cifX Mini PCI and Mini PCI Express	38
3.2.1	CIFX 90-RE\F, CIFX 90E-RE\F and Variants	38
3.2.2	CIFX 90-FB\F, CIFX 90E-FB\F and Variants	39
3.2.3	CIFX 90E-2FB\ET\F and CIFX 90E-2FB\MR\ET\F	40
3.2.4	Reverse Side CIFX 90-XX\F, CIFX 90E-XX\F and Variants	40
3.3	PC Cards cifX PCI-104	41
3.3.1	CIFX 104C-RE, CIFX 104C-RE-R	41
3.3.2	CIFX 104C-RE\F, CIFX 104C-RE-R\F	42
3.3.3	CIFX 104C-DP, CIFX 104C-DP-R	43
3.3.4	CIFX 104C-CO, CIFX 104C-CO-R	44
3.3.5	CIFX 104C-DN, CIFX 104C-DN-R	45
3.3.6	CIFX 104C-DP\F, CIFX 104C-CO\F, CIFX 104C-DN\F, CIFX 104C-CC\F	46
3.3.7	CIFX 104C-DP-R\F, CIFX 104C-CO-R\F, CIFX 104C-DN-R\F	46
3.3.8	Reverse Side CIFX 104C-XX (all Basic Cards and Variants)	47
3.4	Detached Network Interfaces AIFX	48
3.4.1	Ethernet - AIFX-RE	48
3.4.2	Ethernet - AIFX-RE\M12	49
3.4.3	PROFIBUS - AIFX-DP	50
3.4.4	CANopen - AIFX-CO	51
3.4.5	DeviceNet - AIFX-DN	52
3.4.6	CC-Link - AIFX-CC	53
3.4.7	Diagnostic - AIFX-DIAG	54
4	SAFETY	55
4.1	General Note	55
4.2	Intended Use	55
4.3	Personnel Qualification	57
4.4	Safety Instructions	57
4.4.1	Hazardous Voltage, electric Shock	57
4.4.2	Communication Stop during Firmware Update or Configuration Download	58
4.4.3	Mismatching System Configuration	58
4.5	Property Damage	59
4.5.1	Exceeding permissible Supply Voltage	59
4.5.2	Exceeding permissible Signaling Voltage	60
4.5.3	Electrostatic sensitive Devices	60
4.5.4	Power Disconnect while downloading Firmware or Configuration	61
4.5.5	Exceeding the maximum Number of allowed Write/Delete Accesses	61
4.5.6	Invalid Firmware	62
4.5.7	Information and Data Security	62
5	REQUIREMENTS	63
5.1	System Requirements	63
5.1.1	Slot for the PC Cards cifX Compact PCI, Mini PCI, Mini PCIe, PCI-104	63
5.1.2	Notes on the Card Height - PC Card cifX Mini PCI and Mini PCIe	64
5.1.3	Panel Cutout for Installing AIFX	65

5.1.4	Operating Temperature Range for UL Certificate	66
5.1.5	Power Supply and Host Interface.....	67
5.1.6	Warnings on Supply and Signaling Voltage	69
5.1.7	Warnings on Supply and Signaling Voltage (USA)	69
5.1.8	AIFX-RE\M12: Max. permissible Current per external LED	69
5.2	Requirements for Operation of the PC Cards cifX.....	70
5.2.1	Requirements „DMA Mode“	71
5.3	Prerequisites for Certification.....	73
5.3.1	PROFINET IO Certification for IRT and SYNC0 Signal	73
6	INSTALLATION, COMMISSIONING AND UNINSTALLING.....	74
6.1	Overview on Installation and Configuration	75
6.2	Warnings on Installation and Uninstallation	79
6.3	Warnings on Installation and Uninstallation (USA)	79
6.4	Fix Front Plate Sticker at CIFX 80-RE	80
6.5	Installing PC Cards cifX Compact PCI.....	81
6.6	Installing PC Cards cifX Mini PCI and Mini PCI Express	83
6.7	Installing PC Cards cifX PCI-104 (PCI-104-Modules)	88
6.8	Warnings on Firmware or Configuration Download	92
6.9	Warnings on Firmware or Configuration Download (USA)	93
6.10	Notes for the Configuration of the Master Device	94
6.11	Device Names in SYCON.net.....	95
6.12	Update for Firmware, Driver and Software	97
6.13	Instructions for Problem Solving	98
6.14	Note on Exchange Service (Replacement Case)	99
6.15	Uninstalling PC Cards cifX Compact PCI	99
6.16	Uninstalling PC Cards cifX Mini PCI, Mini PCI Express	100
6.17	Uninstalling PC Cards cifX PCI-104	102
6.18	Disposal and recycling of waste electronic equipment	103
7	DIAGNOSIS WITH LEDS	104
7.1	Overview LEDs Real-Time Ethernet Systems	104
7.2	Overview LEDs Fieldbus Systems.....	105
7.3	System LED.....	106
7.4	Power On LED.....	106
7.5	CC-Link IE Field Basic Slave	107
7.6	EtherCAT Master	108
7.7	EtherCAT Slave	110
7.8	EtherNet/IP Scanner (Master)	111
7.9	EtherNet/IP Adapter (Slave)	113
7.10	Open Modbus/TCP	115

7.11	POWERLINK Controlled Node/Slave	116
7.12	PROFINET IO Controller	117
7.13	PROFINET IO-Device.....	119
7.14	Sercos Master.....	120
7.15	Sercos Slave.....	122
7.16	VARAN Client (Slave).....	124
7.17	PROFIBUS DP Master	125
7.17.1	1 Communication Status LED	125
7.17.2	2 Communication Status LEDs	126
7.18	PROFIBUS DP Slave	127
7.18.1	1 Communication Status LED	127
7.18.2	2 Communication Status LEDs	128
7.19	PROFIBUS MPI Device	129
7.19.1	1 Communication Status LED	129
7.19.2	2 Communication Status LEDs	130
7.20	CANopen Master	131
7.20.1	1 Communication Status LED	131
7.20.2	2 Communication Status LEDs	132
7.21	CANopen Slave	133
7.21.1	1 Communication Status LED	133
7.21.2	2 Communication Status LEDs	134
7.22	DeviceNet Master	135
7.23	DeviceNet Slave	136
7.24	CC-Link Slave.....	137
8	DEVICE CONNECTIONS AND SWITCHES	138
8.1	Ethernet Interface	138
8.1.1	Ethernet Pin Assignment at the RJ45 Socket	138
8.1.2	Ethernet Pin Assignment at the M12 Socket.....	139
8.1.3	Ethernet Connection Data	140
8.1.4	Use of Hubs and Switches	140
8.2	PROFIBUS Interface	141
8.3	CANopen Interface	141
8.4	DeviceNet Interface	142
8.5	CC-Link Interface.....	142
8.6	Mini-B USB Connector (5 Pin)	143
8.7	Rotary Switch for PCI-104 Slot Number	143
8.8	Rotary Switch Device Address	144
8.9	Cable Connector.....	145
8.9.1	Pin Assignment Cable Connector Ethernet X4 or X304.....	145
8.9.2	Pin Assignment Cable Connector Fieldbus X3, X304, X4	146
8.9.3	Pin Assignment Cable Connector Fieldbus X3 and X4 for 2 Channel Devices	146

8.9.4	Pin Assignment Cable Connector DIAG	147
8.9.5	Pin Assignment Cable Connector Ethernet X1, AIFX-RE	148
8.9.6	Pin Assignment Cable Connector Ethernet X2, AIFX-RE\M12	149
8.9.7	Pin Assignment Cable Connector LED Signals X3, AIFX-RE\M12	150
8.9.8	Pin Assignment Cable Connector Fieldbus X1, AIFX-DP	151
8.9.9	Pin Assignment Cable Connector Fieldbus X1, AIFX-CO	151
8.9.10	Pin Assignment Cable Connector Fieldbus X1, AIFX-DN	152
8.9.11	Pin Assignment Cable Connector Fieldbus X1, AIFX-CC	152
8.10	Cable for detached Network Interfaces AIFX	153
8.10.1	Cable for AIFX-RE or AIFX-RE\M12	153
8.10.2	Optional Cable Length 20 cm for CIFX 90E variants with AIFX-RE or AIFX-RE\M12	153
8.10.3	Optional Cable Length 30 cm for PC-cards cifX with AIFX-DP, AIFX-CO or AIFX-DN	153
8.11	SYNC Connector (Pin-Assignment, Hardware/Firmware)	154
8.11.1	Pin Assignment SYNC Connector, X51 (CIFX 80 90 104C)	154
8.11.2	Items on Hardware	154
8.11.3	Items on Firmware	154
8.12	Pin Assignment at the PCI Bus	155
8.12.1	Overview	155
8.12.2	Pin Assignment for Mini PCI Bus, X1	156
8.12.3	Pin Assignment for Mini PCI Express Bus / SYNC Connector (Bootstart), X1/X2	158
8.12.4	Pin Assignment for Mini PCI Express Bus, X1/X2 for 2 Channel Devices	160
9	TECHNICAL DATA	162
9.1	Technical Data PC Cards cifX	162
9.1.1	CIFX 80-RE	162
9.1.2	CIFX 80-DP	163
9.1.3	CIFX 80-CO	165
9.1.4	CIFX 80-DN	166
9.1.5	CIFX 90-RE\F, CIFX 90-RE\F\M12	168
9.1.6	CIFX 90-DP\F	170
9.1.7	CIFX 90-CO\F	171
9.1.8	CIFX 90-DN\F	173
9.1.9	CIFX 90-CC\F	174
9.1.10	CIFX 90E-RE\F and Variants	176
9.1.11	CIFX 90E-DP\F and Variants	178
9.1.12	CIFX 90E-CO\F and Variants	181
9.1.13	CIFX 90E-DN\F and Variants	183
9.1.14	CIFX 90E-CC\NHS\F, CIFX 90E-CC\ET\F, CIFX 90E-CC\MR\ET\F	185
9.1.15	CIFX 90E-2DP\ET\F, CIFX 90E-2DP\MR\ET\F	188
9.1.16	CIFX 90E-2DP\CO\ET\F, CIFX 90E-2DP\CO\MR\ET\F	189
9.1.17	CIFX 90E-2DP\DN\ET\F, CIFX 90E-2DP\DN\MR\ET\F	191
9.1.18	CIFX 90E-2CO\ET\F, CIFX 90E-2CO\MR\ET\F	194
9.1.19	CIFX 90E-2CO\DN\ET\F, CIFX 90E-2CO\DN\MR\ET\F	195
9.1.20	CIFX 90E-2DN\ET\F, CIFX 90E-2DN\MR\ET\F	197
9.1.21	CIFX 104C-RE, CIFX 104C-RE-R	200
9.1.22	CIFX 104C-RE\F, CIFX 104C-RE-R\F and Variants	202

9.1.23	CIFX 104C-DP, CIFX 104C-DP-R.....	204
9.1.24	CIFX 104C-DP\F, CIFX 104C-DP-R\F	206
9.1.25	CIFX 104C-CO, CIFX 104C-CO-R.....	207
9.1.26	CIFX 104C-CO\F, CIFX 104C-CO-R\F	210
9.1.27	CIFX 104C-DN, CIFX 104C-DN-R	211
9.1.28	CIFX 104C-DN\F, CIFX 104C-DN-R\F	214
9.1.29	CIFX 104C-CC\F	216
9.1.30	AIFX-RE	218
9.1.31	AIFX-RE\M12	219
9.1.32	AIFX-DP	220
9.1.33	AIFX-CO	221
9.1.34	AIFX-DN	222
9.1.35	AIFX-CC	223
9.1.36	AIFX-DIAG.....	224
9.2	PCI IDs PC Cards cifX on the PCI Bus.....	225
9.3	Supported PCI Bus Commands.....	225
9.4	Technical Data of the Communication Protocols.....	226
9.4.1	CC-Link IE Field Basic Slave	226
9.4.2	EtherCAT Master.....	227
9.4.3	EtherCAT Slave.....	228
9.4.4	EtherNet/IP Scanner (Master)	229
9.4.5	EtherNet/IP Adapter (Slave).....	230
9.4.6	Open Modbus/TCP.....	231
9.4.7	POWERLINK Controlled Node/Slave.....	231
9.4.8	PROFINET IO-Controller.....	232
9.4.9	PROFINET IO-Device	233
9.4.10	Sercos Master	235
9.4.11	Sercos Slave	236
9.4.12	VARAN Client (Slave).....	237
9.4.13	PROFIBUS DP Master	238
9.4.14	PROFIBUS DP Slave	239
9.4.15	PROFIBUS MPI.....	240
9.4.16	CANopen Master	241
9.4.17	CANopen Slave	242
9.4.18	DeviceNet Master.....	243
9.4.19	DeviceNet Slave	244
9.4.20	CC Link Slave.....	245
10	DIMENSIONS.....	246
10.1	Tolerances of the shown Card Dimensions	246
10.2	Dimensioning PC Cards cifX Compact PCI	247
10.2.1	CIFX 80-RE	247
10.2.2	Front Panel CIFX 80-RE	247
10.2.3	CIFX 80-DP	248
10.2.4	Front Panel CIFX 80-DP	248
10.2.5	CIFX 80-CO.....	249
10.2.6	Front Panel CIFX 80-CO	249
10.2.7	CIFX 80-DN	250

10.2.8	Front Panel CIFX 80-DN	250
10.3	Dimensioning PC Cards cifX Mini PCI and Mini PCI Express	251
10.3.1	CIFX 90-XX\F and Variants	251
10.3.2	CIFX 90E-XX\F and Variants	251
10.4	Dimensioning PC Cards cifX PCI-104	252
10.4.1	CIFX 104C-RE	252
10.4.2	CIFX 104C-RE\F	253
10.4.3	CIFX 104C-DP	254
10.4.4	CIFX 104C-CO	255
10.4.5	CIFX 104C-DN	256
10.4.6	CIFX 104C-FB\F	257
10.4.7	Reverse Side CIFX 104C-XX (all Basic Cards and Variants)	258
10.5	Dimensioning detached Network Interfaces AIFX	259
10.5.1	Ethernet - AIFX-RE	259
10.5.2	Ethernet M12 - AIFX-RE\M12	260
10.5.3	PROFIBUS - AIFX-DP	261
10.5.4	CANopen - AIFX-CO	261
10.5.5	DeviceNet - AIFX-DN	262
10.5.6	CC-Link - AIFX-CC	263
10.5.7	Diagnose - AIFX-DIAG	263
11	ANNEX	264
11.1	References	264
11.1.1	References PCI Specifications	264
11.1.2	References Safety	265
11.1.3	Used Terminology	265
11.2	Conventions in this Manual	266
11.3	Legal Notes	267
11.4	Licenses	270
11.4.1	License Note about VARAN Client	270
11.5	Registered Trademarks	271
11.6	EtherCAT Disclaimer	271
11.6.1	EtherCAT Summary over Vendor ID, Conformance test, Membership and Network Logo	272
11.7	Notes on earlier Hardware Revisions	273
11.7.1	Failure in 10 MBit/s Half Duplex Mode and Workaround	273
11.7.2	Pin Assignment for Mini PCI Express Bus / SYNC Connector (Bootstart), X1/X2	275
11.8	List of Figures	277
11.9	List of Tables	280
11.10	Glossary	284
11.11	Contacts	293

1 Introduction

1.1 About the User Manual

This user manual provides descriptions of the **installation, operation and hardware** of the PC cards *cifX Compact PCI, Mini PCI, Mini PCI Express* and *PCI-104* under Windows® 7, Windows® 8 and Windows® 10, as listed subsequently.

PC Cards cifX:

- Compact PCI (CIFX 80),
- Mini PCI (CIFX 90)^A,
- Mini PCI Express (CIFX 90E)^A,
- PCI-104 (CIFX 104C)^{A+B}

for CIFX 90, - 90E and - 104C inclusively the detached network interfaces AIFX:

- | | |
|---|---|
| <ul style="list-style-type: none"> ▪ Ethernet (AIFX-RE)^A ▪ Ethernet M12 (AIFX-REM12)^A | <ul style="list-style-type: none"> ▪ PROFIBUS (AIFX-DP)^A ▪ CANopen (AIFX-CO)^A ▪ DeviceNet (AIFX-DN)^A ▪ CC-Link (AIFX-CC)^A ▪ Diagnose (AIFX-DIAG)^B |
|---|---|

for the Real-Time Ethernet systems:

- CC-Link IE Field-Basic
- EtherCAT
- EtherNet/IP
- Open Modbus/TCP
- POWERLINK
- PROFINET IO
- Sercos
- VARAN

for the fieldbus systems:

- PROFIBUS DP
- PROFIBUS MPI
- CANopen
- DeviceNet
- CC-Link



For information about the **Installation of the Software** refer to the User Manual „Software Installation for PC cards cifX“ [DOC120207UMXXEN]. For information about the **Wiring of the Protocol Interface** refer to the „Wiring Instructions“ [DOC120208UMXXEN].

The **devices described in this manual** are listed in the sections *PC Cards cifX with integrated Interfaces* (page 12) and *PC Cards cifX with detached Network Interface AIFX* (page 13). The devices are described in detail in the chapters *Installation, Commissioning and Uninstalling* (page 74), *Diagnosis with LEDs* (page 104), *Device Connections and Switches* (page 138) and *Technical Data* (page 162).

You can download the latest edition of a manual from the website www.hilscher.com under **Support > Downloads > Manuals** or under **Products** directly with the information about your product.

1.2 List of Revisions

Index	Date	Chapter	Revisions
55	21-09-30	2.6.3, 2.6.4, 2.7.2, 2.7.3, 3.4.5, 10.5.5, 7.17.2, 7.18.2, 7.20.2, 7.21.2, 7.9, 8.1.4, 8.9.5, 8.9.8, 8.9.9, 8.9.10, 8.9.11, 9.1, 9.4, 10.5.1, 10.5.6, 10.5.5	Section <i>Important Changes</i> updated, Windows® 10 added. Section <i>Device Description Files cifX</i> updated. Section <i>Hardware: Product Components for PC Cards cifX</i> , AIFX-RE, Rev. 2. Section <i>Firmware</i> updated. Sections <i>DeviceNet - AIFX-DN</i> and <i>DeviceNet - AIFX-DN: Representation with counterpart</i> . Sections <i>2 Communication Status LEDs</i> , <i>2 Communication Status LEDs</i> , <i>2 Communication Status LEDs</i> : Update ERR LED description. Section <i>EtherNet/IP Adapter (Slave)</i> updated. Section <i>Use of Hubs and Switches</i> updated. Sections <i>Pin Assignment Cable Connector Ethernet X1</i> , <i>AIFX-RE</i> , <i>Pin Assignment Cable Connector Fieldbus X1</i> , <i>AIFX-DP</i> , <i>Pin Assignment Cable Connector Fieldbus X1</i> , <i>AIFX-CO</i> , <i>Pin Assignment Cable Connector Fieldbus X1</i> , <i>AIFX-DN</i> , <i>Pin Assignment Cable Connector Fieldbus X1</i> , <i>AIFX-CC</i> added. Section <i>Technical Data PC Cards cifX: UKCA</i> added. Section <i>Technical Data of the Communication Protocols</i> updated (EtherCAT Master V3, POWERLINK Controlled Node/Slave V2 as well as PROFINET IO-Controller V2 removed, PROFINET IO-Device V3.4 respectively V3.13 removed respectively updated to V4) Section <i>Ethernet - AIFX-RE</i> revised. Sections <i>DeviceNet - AIFX-DN</i> and <i>CC-Link - AIFX-CC</i> updated.
56	22-03-21	All	Language revision of safety instructions.
57	23-04-03	6.18, 10.5.6	Warnings in the manual revised (positions and layout). Section <i>Disposal and recycling of waste electronic equipment</i> updated. Section <i>CC-Link - AIFX-CC</i> , position of lower screw hole corrected.

Table 1: List of Revisions

1.3 Obligation to read and understand the Manual



Important!

- To avoid personal injury and to avoid property damage to your system or to your PC card, you must read and understand all instructions in the manual and all accompanying texts to your PC card, before installing and operating your PC card.
- First read the **Safety Instructions** in the safety chapter.
- Obey to all **Safety Messages** in the manual.
- Keep the product DVD as ZIP file providing the product manuals.

2 Descriptions of the PC Cards

2.1 Description

The PC cards cifX are communication interfaces of the cifX product family of Hilscher on the basis of the communication controller netX 100 for the Real-Time Ethernet or fieldbus communication. Depending of the loaded firmware, the protocol specific PC card cifX proceeds the communication of the corresponding Real-Time Ethernet or fieldbus system.

The used Real-Time Ethernet systems are: The used fieldbus systems are:

- CC-Link IE Field Basic Slave
- EtherCAT Master
- EtherCAT Slave
- EtherNet/IP Scanner (Master)
- EtherNet/IP Adapter (Slave)
- Open Modbus/TCP
- POWERLINK-Controlled-Node/Slave
- PROFINET IO-Controller (Master)
- PROFINET IO-Device (Slave)
- Sercos Master
- Sercos Slave
- VARAN Client (Slave)
- PROFIBUS DP Master
- PROFIBUS DP Slave
- PROFIBUS MPI Device
- CANopen Master
- CANopen Slave
- DeviceNet Master
- DeviceNet Slave
- CC-Link Slave

The PC card cifX handles the complete data exchange between the connected Ethernet or fieldbus devices and the PC. The data exchange is proceeded via dual-port memory.

2.2 PC Cards cifX with integrated Interfaces

The PC cards Compact PCI CIFX 80-XX and the PC cards PCI-104 CIFX 104C-XX and CIFX 104C-XX-R provide integrated Ethernet, fieldbus or diagnostic interfaces.

2.2.1 PC Cards Compact PCI CIFX 80-XX

PC Card cifX	Description
PC Cards Compact PCI with integrated Ethernet, fieldbus or diagnostic interface	
Real-Time Ethernet	
CIFX 80-RE	Real-Time Ethernet Master or Slave
PROFIBUS	
CIFX 80-DP	PROFIBUS DP Master or Slave and PROFIBUS MPI Device
CANopen	
CIFX 80-CO	CANopen Master or Slave
DeviceNet	
CIFX 80-DN	DeviceNet Master or Slave

Table 2: PC Cards Compact PCI CIFX 80-XX

2.2.2 PC Cards PCI-104: CIFX 104C-XX and CIFX 104C-XX-R

PC Card cifX	Description
PC Cards PCI-104 with integrated Ethernet, fieldbus or diagnostic interface	
Real-Time Ethernet	
CIFX 104C-RE	Real-Time Ethernet Master or Slave
CIFX 104C-RE-R	Real-Time Ethernet Master or Slave (connectors at the left side)
PROFIBUS	
CIFX 104C-DP	PROFIBUS DP Master or Slave and PROFIBUS MPI Device
CIFX 104C-DP-R	PROFIBUS DP Master or Slave and PROFIBUS MPI Device (connectors at the left side)
CANopen	
CIFX 104C-CO	CANopen Master or Slave
CIFX 104C-CO-R	CANopen Master or Slave (connectors at the left side)
DeviceNet	
CIFX 104C-DN	DeviceNet Master or Slave
CIFX 104C-DN-R	DeviceNet Master or Slave (connectors at the left side)

Table 3: PC Cards PCI-104: CIFX 104C-XX and CIFX 104C-XX-R

2.3 PC Cards cifX with detached Network Interface AIFX

2.3.1 The Label „\F“ in the Device Name

The PC cards cifX including the label “\F” in its device name are composed of a basic card and a detached network interface AIFX.

- The basic cards CIFX 90, CIFX 90E, CIFX 90E\NHS, CIFX 90E\ET, CIFX 90E\MR and, CIFX 90E\MR\ET are equipped with a **Cable Connector Ethernet**, to connect the Ethernet detached network interface (AIFX-RE) or the Ethernet M12 detached network interface (AIFX-RE\M12) in addition they are equipped with a **Cable Connector Fieldbus**, to alternatively connect the detached network interface PROFIBUS (AIFX-DP), CANopen (AIFX-CO), DeviceNet (AIFX-DN) or CC-Link (AIFX-CC*).(*only for CIFX 90, CIFX 90E\NHS, CIFX 90E\ET and CIFX 90E\MR\ET)
- The basic cards CIFX 90E-2FB\ET and CIFX 90E-2FB\MR\ET are equipped with **Cable Connectors Fieldbus**, to connect two detached network interfaces PROFIBUS (AIFX-DP), CANopen (AIFX-CO) or DeviceNet (AIFX-DN); (Note: 'FB' stands for ‚Fieldbus‘).
- The basic cards CIFX 104C-RE\F and CIFX 104C-RE-R\F are equipped with a **Cable Connector Ethernet**, to connect the Ethernet detached network interface (AIFX-RE) or the Ethernet M12 detached network interface (AIFX-RE\M12).
- The basic cards CIFX 104C-FB\F and CIFX 104C-FB-R\F are equipped with a **Cable Connector Fieldbus**, to connect the detached network interface PROFIBUS (AIFX-DP), CANopen (AIFX-CO), DeviceNet (AIFX-DN) or CC-Link (AIFX-CC*); (*only for CIFX 104C-FB\F; Note: 'FB' stands for ‚Fieldbus‘.)
- The basic cards CIFX 104C-RE\F, CIFX 104C-RE-R\F, CIFX 104C-FB\F and CIFX 104C-FB-R\F are additionally equipped with a **Cable Connector DIAG**, to optionally connect the diagnostic detached network interface (AIFX-DIAG).



Important! Operating the PC cards cifX Mini PCI, Mini PCI Express or PCI-104 with AIFX detached network interface (label “\F” in the device name) requires proper connection of the Ethernet (AIFX-RE), the Ethernet M12 (AIFX-RE\M12), PROFIBUS (AIFX-DP), CANopen (AIFX-CO), DeviceNet (AIFX-DN) or CC-Link (AIFX-CC) detached network interface to the basic card! For 2-channel devices both detached network interfaces must be connected.

2.3.2 PC Cards Mini PCI CIFX 90-XX\F and Variant

PC Card cifX	Description
PC Cards Mini PCI with AIFX detached Network Interface	
Real-Time Ethernet	
CIFX 90-RE\F	Real-Time Ethernet Master or Slave - Basic card CIFX 90 and - Ethernet detached network interface (AIFX-RE).
CIFX 90-RE\F\M12	Real-Time Ethernet Master or Slave - Basic card CIFX 90 and - Ethernet M12 detached network interface (AIFX-RE\M12).
PROFIBUS	
CIFX 90-DP\F	PROFIBUS DP Master or Slave or PROFIBUS MPI Devicet - Basic card CIFX 90 and - PROFIBUS detached network interface (AIFX-DP).
CANopen	
CIFX 90-CO\F	CANopen Master or Slave - Basic card CIFX 90 and - CANopen detached network interface (AIFX-CO).
DeviceNet	
CIFX 90-DN\F	DeviceNet Master or Slave - Basic card CIFX 90 and - DeviceNet detached network interface (AIFX-DN).
CC-Link	
CIFX 90-CC\F	CC-Link Slave - Basic card CIFX 90 and - CC-Link detached network interface (AIFX-CC).

Table 4: PC Cards Mini PCI CIFX 90-XX\F, CIFX 90-RE\F\M12



Note: The device height and the power input of the PC cards CIFX 90-RE\F, CIFX 90-RE\F\M12, CIFX 90-DP\F, CIFX 90-CO\F, CIFX 90-DN\F and CIFX 90-DN\F do not comply with the standard specifications.

2.3.3 PC Cards Mini PCI Express CIFX 90E-XX\F and Variant

PC Card cifX	Description
PC Cards Mini PCI Express with AIFX detached Network Interface	
Real-Time Ethernet	
CIFX 90E-RE\F	Real-Time Ethernet Master or Slave - Basic card CIFX 90E and - Ethernet detached network interface (AIFX-RE).
CIFX 90E-RE\F\M12	Real-Time Ethernet Master or Slave - Basic card CIFX 90E and - Ethernet M12 detached network interface (AIFX-RE\M12).
PROFIBUS	
CIFX 90E-DP\F	PROFIBUS DP Master or Slave or PROFIBUS MPI Device - Basic card CIFX 90E and - PROFIBUS detached network interface (AIFX-DP).
CANopen	
CIFX 90E-CO\F	CANopen Master or Slave - Basic card CIFX 90E and - CANopen detached network interface (AIFX-CO).
DeviceNet	
CIFX 90E-DN\F	DeviceNet Master or Slave - Basic card CIFX 90E and - DeviceNet detached network interface (AIFX-DN).

Table 5: PC Cards Mini PCI Express CIFX 90E-XX\F, CIFX 90E-RE\F\M12



Note: The device height and the power input of the PC cards CIFX 90E-RE\F, CIFX 90E-RE\F\M12, CIFX 90E-DP\F, CIFX 90E-CO\F and CIFX 90E-DN\F do not comply with the standard specifications.

2.3.4 PC Cards Mini PCI Express CIFX 90E-XX\NHS\F and Variant

PC Card cifX	Description
PC Cards Mini PCI Express ,NHS' (no heat sink) with AIFX detached Network Interface	
Real-Time Ethernet	
CIFX 90E-RE\NHS\F	Real-Time Ethernet Master or Slave - Basic card CIFX 90E\NHS and - Ethernet detached network interface (AIFX-RE).
CIFX 90E-RE\NHS\F\M12	Real-Time Ethernet Master or Slave - Basic card CIFX 90E\NHS and - Ethernet M12 detached network interface (AIFX-RE\M12).
PROFIBUS	
CIFX 90E-DP\NHS\F	PROFIBUS DP Master or Slave or PROFIBUS MPI Device - Basic card CIFX 90E\NHS and - PROFIBUS detached network interface (AIFX-DP).
CANopen	
CIFX 90E-CO\NHS\F	CANopen Master or Slave - Basic card CIFX 90E\NHS and - CANopen detached network interface (AIFX-CO).
DeviceNet	
CIFX 90E-DN\NHS\F	DeviceNet Master or Slave - Basic card CIFX 90E\NHS and - DeviceNet detached network interface (AIFX-DN).
CC-Link	
CIFX 90E-CC\NHS\F	CC-Link Slave - Basic card CIFX 90E\NHS and - CC-Link detached network interface (AIFX-CC).

Table 6: PC Cards Mini PCI Express CIFX 90E-XX\NHS\F, CIFX 90E-RE\NHS\F\M12



Note: The device height and the power input of the PC cards CIFX 90E-RE\NHS\F, CIFX 90E-RE\NHS\F\M12, CIFX 90E-DP\NHS\F, CIFX 90E-CO\NHS\F, CIFX 90E-DN\NHS\F and CIFX 90E-CC\NHS\F do not comply with the standard specifications.

2.3.5 PC Cards Mini PCI Express CIFX 90E-XX\ET\F and Variant

PC Card cifX	Description
PC Cards Mini PCI Express with AIFX detached Network Interface and enlarged Temperature Range ,ET'	
Real-Time Ethernet	
CIFX 90E-RE\ET\F	Real-Time Ethernet Master or Slave - Basic card CIFX 90E\ET and - Ethernet detached network interface (AIFX-RE).
CIFX 90E-XX\ET\FM12	Real-Time Ethernet Master or Slave - Basic card CIFX 90E\ET and - Ethernet M12 detached network interface (AIFX-RE\M12).
PROFIBUS	
CIFX 90E-DP\ET\F	PROFIBUS DP Master or Slave or PROFIBUS MPI Device - Basic card CIFX 90E\ET and - PROFIBUS detached network interface (AIFX-DP).
CANopen	
CIFX 90E-CO\ET\F	CANopen Master or Slave - Basic card CIFX 90E\ET and - CANopen detached network interface (AIFX-CO).
DeviceNet	
CIFX 90E-DN\ET\F	DeviceNet Master or Slave - Basic card CIFX 90E\ET and - DeviceNet detached network interface (AIFX-DN).
CC-Link	
CIFX 90E-CC\ET\F	CC-Link Slave - Basic card CIFX 90E\ET and - CC-Link detached network interface (AIFX-CC).

Table 7: PC Cards Mini PCI Express CIFX 90E-XX\ET\F, CIFX 90E-XX\ET\FM12



Note: For the PC cards CIFX 90E-RE\ET\F, CIFX 90E-XX\ET\FM12, CIFX 90E-DP\ET\F, CIFX 90E-CO\ET\F, CIFX 90E-DN\ET\F and CIFX 90E-CC\ET\F the following is valid:

- (1) The PC cards can be used in an enlarged temperature range from -20 °C to +70 °C.
- (2) The device height and the power input of the PC cards do not comply with the standard specifications.

2.3.6 PC Cards Mini PCI Express CIFX 90E-XX\MR\F and Variant

PC Card cifX	Description
PC Cards Mini PCI Express with AIFX detached Network Interface and additional MRAM ,MR'	
Real-Time Ethernet	
CIFX 90E-RE\MR\F	Real-Time Ethernet Master or Slave - Basic card CIFX 90EVMR and - Ethernet detached network interface (AIFX-RE).
CIFX 90E-RE\MR\F	Real-Time Ethernet Master or Slave - Basic card CIFX 90EVMR and - Ethernet M12 detached network interface (AIFX-RE\M12).
PROFIBUS	
CIFX 90E-DP\MR\F	PROFIBUS DP Master or Slave or PROFIBUS MPI Device - Basic card CIFX 90EVMR and - PROFIBUS detached network interface (AIFX-DP).
CANopen	
CIFX 90E-CO\MR\F	CANopen Master or Slave - Basic card CIFX 90EVMR and - CANopen detached network interface (AIFX-CO).
DeviceNet	
CIFX 90E-DN\MR\F	DeviceNet Master or Slave - Basic card CIFX 90EVMR and - DeviceNet detached network interface (AIFX-DN).

Table 8: PC Cards Mini PCI Express CIFX 90E-XX\MR\F, CIFX 90E-RE\MR\F\M12



Note: For the PC cards CIFX 90E-RE\MR\F, CIFX 90E-RE\MR\F\M12, CIFX 90E-DP\MR\F, CIFX 90E-CO\MR\F and CIFX 90E-DN\MR\F the following is valid:

(1) The PC cards are equipped with an MRAM (128Kbyte = 64K Words). For further information refer to section *PC Cards cifX with additional MRAM* on page 24.

(2) The device height and the power input of the PC cards do not comply with the standard specifications.

2.3.7 PC Cards Mini PCI Express CIFX 90E-XX\MR\ET\F and Variant

PC Card cifX	Description
PC Cards Mini PCI Express with AIFX detached Network Interface, additional MRAM ,MR' and enlarged Temperature Range ,ET'	
Real-Time Ethernet	
CIFX 90E-RE\MR\ET\F	Real-Time Ethernet Master or Slave - Basic card CIFX 90E\MR\ET and - Ethernet detached network interface (AIFX-RE).
CIFX 90E-RE\MR\ET\F\M12	Real-Time Ethernet Master or Slave - Basic card CIFX 90E\MR\ET and - Ethernet M12 detached network interface (AIFX-RE\M12).
PROFIBUS	
CIFX 90E-DP\MR\ET\F	PROFIBUS DP Master or Slave or PROFIBUS MPI Devicet - Basic card CIFX 90E\MR\ET and - PROFIBUS detached network interface (AIFX-DP).
CANopen	
CIFX 90E-CO\MR\ET\F	CANopen Master or Slave - Basic card CIFX 90E\MR\ET and - CANopen detached network interface (AIFX-CO).
DeviceNet	
CIFX 90E-DN\MR\ET\F	DeviceNet Master or Slave - Basic card CIFX 90E\MR\ET and - DeviceNet detached network interface (AIFX-DN).
CC-Link	
CIFX 90E-CC\MR\ET\F	CC-Link Slave - Basic card CIFX 90E\MR\ET and - CC-Link detached network interface (AIFX-CC).

Table 9: PC Cards Mini PCI Express CIFX 90E-XX\MR\ET\F, CIFX 90E-RE\MR\ET\F\M12



Note: For the PC cards CIFX 90E-RE\MR\ET\F, CIFX 90E-RE\MR\ET\F\M12, CIFX 90E-DP\MR\ET\F, CIFX 90E-CO\MR\ET\F, CIFX 90E-DN\MR\ET\F and CIFX 90E-CC\MR\ET\F the following is valid:

- (1) The PC cards are equipped with an MRAM (128Kbyte = 64K Words). For further information refer to section *PC Cards cifX with additional MRAM* on page 24.
- (2) The PC cards can be used in an enlarged temperature range from -20 °C to +70 °C.
- (3) The device height and the power input of the PC cards do not comply with the standard specifications.

2.3.8 PC Cards Mini PCI Express (2 Channels) CIFX 90E-2XX\ET\F, CIFX 90E-2XX\XX\ET\F

PC Card cifX	Description
PC Cards Mini PCI Express (2 channels) with AIFX detached Network Interface and enlarged Temperature Range ,ET'	
PROFIBUS	
CIFX 90E-2DP\ET\F	PROFIBUS DP Master or Slave - Basic card CIFX 90E-2FB\ET and - 2 x PROFIBUS detached network interface (AIFX-DP).
PROFIBUS, CANopen	
CIFX 90E-2DP\CO\ET\F	PROFIBUS DP Master or Slave and CANopen Master or Slave - Basic card CIFX 90E-2FB\ET, - Cable Connector X3: PROFIBUS detached network interface (AIFX-DP) and - Cable Connector X4: CANopen detached network interface (AIFX-CO).
PROFIBUS, DeviceNet	
CIFX 90E-2DP\DN\ET\F	PROFIBUS DP Master or Slave and DeviceNet Master or Slave - Basic card CIFX 90E-2FB\ET, - Cable Connector X3: PROFIBUS detached network interface (AIFX-DP) and - Cable Connector X4: DeviceNet detached network interface (AIFX-DN).
CANopen	
CIFX 90E-2CO\ET\F	CANopen Master or Slave - Basic card CIFX 90E-2FB\ET and - 2 x CANopen detached network interface (AIFX-CO).
CANopen, DeviceNet	
CIFX 90E-2CO\DN\ET\F	CANopen Master or Slave and DeviceNet Master or Slave - Basic card CIFX 90E-2FB\ET, - Cable Connector X3: CANopen detached network interface (AIFX-CO) and - Cable Connector X4: DeviceNet detached network interface (AIFX-DN).
DeviceNet	
CIFX 90E-2DN\ET\F	DeviceNet-Master or -Slave - Basic card CIFX 90E-2FB\ET and - 2 x DeviceNet detached network interface (AIFX-DN).

Table 10: PC Cards Mini PCI Express (2 Channels) CIFX 90E-2XX\ET\F, CIFX 90E-2XX\XX\ET\F



Note: For the PC cards CIFX 90E-2DP\ET\F, CIFX 90E-2DP\CO\ET\F, CIFX 90E-2DP\DN\ET\F, CIFX 90E-2CO\ET\F, CIFX 90E-2CO\DN\ET\F and CIFX 90E-2DN\ET\F the following is valid:

(1) The PC cards can be used in an enlarged temperature range from -20°C to +70°C.

(2) The device height and the power input of the PC cards do not comply with the standard specifications.

2.3.9 PC Cards Mini PCI Express (2 Channels) CIFX 90E-2XX\MR\ET\F, CIFX 90E-2XX\XX\MR\ET\F

PC Card cifX	Description
PC Cards Mini PCI Express (2 channels) with AIFX detached Network Interface, additional MRAM ,MR' and enlarged Temperature Range ,ET'	
PROFIBUS	
CIFX 90E-2DP\MR\ET\F	PROFIBUS DP Master or Slave - Basic card CIFX 90E-2FB\MR\ET and - 2 x PROFIBUS detached network interface (AIFX-DP).
PROFIBUS, CANopen	
CIFX 90E-2DP\CO\MR\ET\F	PROFIBUS DP Master or Slave and CANopen Master or Slave - Basic card CIFX 90E-2FB\MR\ET, - Cable Connector X3: PROFIBUS detached network interface (AIFX-DP) and - Cable Connector X4: CANopen detached network interface (AIFX-CO).
PROFIBUS, DeviceNet	
CIFX 90E-2DP\DN\MR\ET\F	PROFIBUS DP Master or Slave and DeviceNet Master or Slave - Basic card CIFX 90E-2FB\MR\ET, - Cable Connector X3: PROFIBUS detached network interface (AIFX-DP) and - Cable Connector X4: DeviceNet detached network interface (AIFX-DN).
CANopen	
CIFX 90E-2CO\MR\ET\F	CANopen Master or Slave - Basic card CIFX 90E-2FB\MR\ET and - 2 x CANopen detached network interface (AIFX-CO).
CANopen, DeviceNet	
CIFX 90E-2CO\DN\MR\ET\F	CANopen Master or Slave and DeviceNet Master or Slave - Basic card CIFX 90E-2FB\MR\ET, - Cable Connector X3: CANopen detached network interface (AIFX-CO) and - Cable Connector X4: DeviceNet detached network interface (AIFX-DN).
DeviceNet	
CIFX 90E-2DN\MR\ET\F	DeviceNet-Master or -Slave - Basic card CIFX 90E-2FB\MR\ET and - 2 x DeviceNet detached network interface (AIFX-DN).

Table 11: PC Cards Mini PCI Express (2 Channels) CIFX 90E-2XX\MR\ET\F, CIFX 90E-2XX\XX\MR\ET\F



Note: For the PC cards CIFX 90E-2DP\MR\ET\F, CIFX 90E-2DP\CO\MR\ET\F, CIFX 90E-2DP\DN\MR\ET\F, CIFX 90E-2CO\MR\ET\F, CIFX 90E-2CO\DN\MR\ET\F and CIFX 90E-2DN\MR\ET\F the following is valid:

- (1) The PC cards are equipped with an MRAM (128Kbyte = 64K Words). For further information refer to section *PC Cards cifX with additional MRAM* on page 24.
- (2) The PC cards can be used in an enlarged temperature range from -20 °C to +70 °C.
- (3) The device height and the power input of the PC cards do not comply with the standard specifications.

2.3.10 PC Cards PCI-104: CIFX 104C-XX\F, CIFX 104C-XX-R\F and Variants

PC Card cifX	Description
PC Cards PCI-104 with detached Network Interface AIFX	
Real-Time Ethernet	
CIFX 104C-RE\F	Real-Time Ethernet Master or Slave - Basic card CIFX 104C-RE\F and - Ethernet detached network interface (AIFX-RE).
CIFX 104C-RE-R\F	Real-Time Ethernet Master or Slave (connectors at the left side) - Basic card CIFX 104C-RE-R\F and - Ethernet detached network interface (AIFX-RE).
CIFX 104C-RE\F\M12	Real-Time Ethernet Master or Slave - Basic card CIFX 104C-RE\F and - Ethernet M12 detached network interface (AIFX-RE\M12).
CIFX 104C-RE-R\F\M12	Real-Time Ethernet Master or Slave (connectors at the left side) - Basic card CIFX 104C-RE-R\F and - Ethernet M12 detached network interface (AIFX-RE\M12).
PROFIBUS	
CIFX 104C-DP\F	PROFIBUS DP Master or Slave or PROFIBUS MPI Device - Basic card CIFX 104C-FB\F and - PROFIBUS detached network interface (AIFX-DP).
CIFX 104C-DP-R\F	PROFIBUS DP Master or Slave or PROFIBUS MPI Device (connectors at the left side) - Basic card CIFX 104C-FB-R\F and - PROFIBUS detached network interface (AIFX-DP).
CANopen	
CIFX 104C-CO\F	CANopen Master or Slave - Basic card CIFX 104C-FB\F and - CANopen detached network interface (AIFX-CO).
CIFX 104C-CO-R\F	CANopen Master or Slave (connectors at the left side) - Basic card CIFX 104C-FB-R\F and - CANopen detached network interface (AIFX-CO).
DeviceNet	
CIFX 104C-DN\F	DeviceNet Master or Slave - Basic card CIFX 104C-FB\F and - DeviceNet detached network interface (AIFX-DN).
CIFX 104C-DN-R\F	DeviceNet Master or Slave (connectors at the left side) - Basic card CIFX 104C-FB-R\F and - DeviceNet detached network interface (AIFX-DN).
CC-Link	
CIFX 104C-CC\F	CC-Link Master or Slave - Basic card CIFX 104C-FB\F and - CC-Link detached network interface (AIFX-CC).

Table 12: PC Cards PCI-104: CIFX 104C-XX\F, CIFX 104C-XX-R\F, CIFX 104C-RE\F\M12, CIFX 104C-RE-R\F\M12

2.3.11 Detached Network Interfaces AIFX

AIFX	Description	For the PC Cards cifX
AIFX-RE	Ethernet detached network interface	CIFX 90-RE\F, CIFX 90E-RE\F, CIFX 90E-RE\NHS\F, CIFX 90E-RE\ET\F, CIFX 90E-RE\MR\F, CIFX 90E-RE\MR\ET\F, CIFX 104C-RE\F, CIFX 104C-RE-R\F
AIFX-RE\M12	Ethernet M12 detached network interface	CIFX 90-RE\F\M12, CIFX 90E-RE\F\M12, CIFX 90E-RE\NHS\F\M12, CIFX 90E-RE\ET\F\M12, CIFX 90E-RE\MR\F\M12, CIFX 90E-RE\MR\ET\F\M12, CIFX 104C-RE\F\M12, CIFX 104C-RE-R\F\M12
AIFX-DP	PROFIBUS detached network interface	CIFX 90-DP\F, CIFX 90E-DP\F, CIFX 90E-DP\NHS\F, CIFX 90E-DP\ET\F, CIFX 90E-DP\MR\F, CIFX 90E-DP\MR\ET\F, CIFX 90E-2DP\ET\F, CIFX 90E-2DP\CO\ET\F, CIFX 90E-2DP\DN\ET\F, CIFX 90E-2DP\MR\ET\F, CIFX 90E-2DP\CO\MR\ET\F, CIFX 90E-2DP\DN\MR\ET\F, CIFX 104C-DP\F, CIFX 104C-DP-R\F
AIFX-CO	CANopen detached network interface	CIFX 90-CO\F, CIFX 90E-CO\F, CIFX 90E-CO\NHS\F, CIFX 90E-CO\ET\F, CIFX 90E-CO\MR\F, CIFX 90E-CO\MR\ET\F, CIFX 90E-2CO\ET\F, CIFX 90E-2CO\DN\ET\F, CIFX 90E-2DP\CO\ET\F, CIFX 90E-2CO\MR\ET\F, CIFX 90E-2CO\DN\MR\ET\F, CIFX 90E-2DP\CO\MR\ET\F, CIFX 104C-CO\F, CIFX 104C-CO-R\F
AIFX-DN	DeviceNet detached network interface	CIFX 90-DN\F, CIFX 90E-DN\F, CIFX 90E-DN\NHS\F, CIFX 90E-DN\ET\F, CIFX 90E-DN\MR\F, CIFX 90E-DN\MR\ET\F, CIFX 90E-2DN\ET\F, CIFX 90E-2CO\DN\ET\F, CIFX 90E-2DP\DN\ET\F, CIFX 90E-2DN\MR\ET\F, CIFX 90E-2CO\DN\MR\ET\F, CIFX 90E-2DP\DN\MR\ET\F, CIFX 104C-DN\F, CIFX 104C-DN-R\F
AIFX-CC	CC-Link detached network interface	CIFX 90-CC\F, CIFX 90E-CC\NHS\F, CIFX 90E-CC\ET\F, CIFX 90E-CC\MR\ET\F, CIFX 104C-CC\F
AIFX-DIAG (optional)	Diagnostic detached network interface	CIFX 104C-RE\F, CIFX 104C-RE-R\F, CIFX 104C-DP\F, CIFX 104C-DP-R\F, CIFX 104C-CO\F, CIFX 104C-CO-R\F, CIFX 104C-DN\F, CIFX 104C-DN-R\F, CIFX 104C-CC\F

Table 13: Detached Network Interfaces AIFX for PC Cards cifX with Cable Connector

2.4 The Function „DMA Mode“

Device revisions which provide **DMA Mode** are listed separately in section *Hardware: PC Cards cifX* on page 28.

The **DMA Mode** is activated via the device driver **cifX Device Driver**.



For further information refer to the user manual **Software Installation for the PC Cards cifX** in section *Activating DMA Mode in the cifX Device Driver Setup*.

2.5 PC Cards cifX with additional MRAM

The PC cards

- CIFX 90E-XX\MR\F (CIFX 90E-RE\MR\F, CIFX 90E-DP\MR\F, CIFX 90E-CO\MR\F, CIFX 90E-DN\MR\F), or CIFX 90E-RE\MR\F\M12,
- CIFX 90E-XX\MR\ET\F (CIFX 90E-RE\MR\ET\F, CIFX 90E-DP\MR\ET\F, CIFX 90E-CO\MR\ET\F, CIFX 90E-DN\MR\ET\F, CIFX 90E-CC\MR\ET\F), or CIFX 90E-RE\MR\ET\F\M12,

are identical to the PC cards CIFX 90E-XX and work with the same firmware. However, the PC cards CIFX 90E-XX\MR\F or CIFX 90E-XX\MR\ET\F (and its variants with Ethernet M12 detached network interface) have an additional memory module for storing remanent data, MRAM with 128Kbyte (= 64K words). Using the cifX Device Driver (from Version 1.1.1.0) access from the application program to this memory is possible and it can be used as a remanent memory for the host system.

The 2 channel PC cards CIFX 90E-2XX\MR\ET\F (CIFX 90E-2DP\MR\ET\F, CIFX 90E-2CO\MR\ET\F, CIFX 90E-2DN\MR\ET\F) and CIFX 90E-2XX\XX\MR\ET\F (CIFX 90E-2DP\CO\MR\ET\F, CIFX 90E-2DP\DN\MR\ET\F, CIFX 90E-2CO\DN\MR\ET\F) also provide the MRAM module with 128Kbyte (= 64K words).

2.6 Contents of the Product DVD



Note! In order to download the product DVD, you need Internet access.

On the **Communication Solutions DVD** you will find these installation instructions about the software installation and the necessary configuration software, the documentation, the drivers and software for your PC card cifX, and additional auxiliary tools. You can download this product DVD as a ZIP file from the website <http://www.hilscher.com> (under Products, directly with the information on your product).

2.6.1 Installation Guide, Documentation Overview



The installation guide **Software Installation and Documentation Overview** on the Communication Solutions DVD are in the directory *Documentation\0. Installation and Overview*. The installation guide includes:

- An overview on the **Content of the Communication Solutions DVD** (in the section *What is on the Communication Solutions DVD?*)
 - Overviews listing the available **Documentations** for PC cards cifX (in chapter *PC Cards cifX, Software and Documentation*).
-

2.6.2 What's New



All current version information for hardware and software described in this manual are provided in the folder *\Documentation\What's New - Communication Solutions DVD RL XX EN.pdf* on the Communication Solutions DVD.

2.6.3 Important Changes

2.6.3.1 EtherNet/IP Adapter Firmware Version V3.6

New firmware version 3.6 for EtherNet/IP-Adapter

The EtherNet/IP-Adapter firmware has been revised and is now available as V3.6.

Use the EtherNet/IP-Adapter firmware V3.6 for a new installation when creating or developing your application program for the first time.

If you want to change from firmware version 3.3 to version 3.5, please refer to the Migration Guide under <https://kb.hilscher.com/x/NqhTC>.

2.6.3.2 PROFINET IO-Device Firmware Version V4.5

New firmware version 4.5 for PROFINET IO-Device

The PROFINET IO-Device firmware has been revised and is now available as V4.5.

Use the PROFINET IO-Device firmware V4.5 for a new installation when creating or developing your application program for the first time.

If you want to change from an older firmware version to the latest version in an existing system, please refer to the Migration Guide, which is available under <https://kb.hilscher.com/x/IRyRBg>.

2.6.4 Device Description Files cifX

The Communication Solutions DVD **EDS** (or **DeviceDescription**) directory includes the device description files for the PC cards cifX. The device description file is required to configure the used Master device. The systems Open Modbus/TCP, PROFIBUS MPI and VARAN do not use device description files.

Real-Time-Ethernet



PC Cards cifX	System	File Name of the Device Description File
CIFX 80-RE	CC-Link IE Field Basic Slave	<i>0x0352_CIFX RE CCIEBS_1_en.cspp</i>
CIFX 90-RE\F		
CIFX 90-RE\F\M12	EtherCAT Slave	<i>Hilscher CIFX RE ECS V4.6.X.xml</i>
CIFX 90E-RE\F	EtherCAT Master	<i>Hilscher Master Redundancy Port.xml</i>
CIFX 90E-RE\F\M12	EtherNet/IP Adapter (Slave)	<i>HILSCHER CIFX-RE EIS V1.1.EDS</i>
CIFX 90E-RE\NHS\F		
CIFX 90E-RE\NHS\F\M12	EtherNet/IP Scanner (Master)	<i>HILSCHER CIFX-RE EIM V1.0.eds</i>
CIFX 90E-RE\ET\F		
CIFX 90E-RE\ET\F\M12	 Note! The description files for the EtherNet/IP Master device is needed, when an additional EtherNet/IP Master device shall communicate to a Hilscher EtherNet/IP Master device via EtherNet/IP.	
CIFX 90E-RE\MR\F		
CIFX 90E-RE\MR\F\M12		
CIFX 90E-RE\MR\ET\F		
CIFX 90E-RE\MR\ET\F\M12		
CIFX 104C-RE	POWERLINK Controlled Node/Slave	<i>00000044_CIFX RE PLS.xdd</i>
CIFX 104C-RE-R	PROFINET IO-Device	<i>GSDML-V2.35-HILSCHER-CIFX RE PNS-yyyyymmdd.xml</i>
CIFX 104C-RE\F	Sercos Slave	<i>SDDML#v3.0#Hilscher#CIFX_RE-FIXCFG_FSPIO#yyyy-mm-dd.xml, SDDML#v3.0#Hilscher#CIFX_RE-VARCFG_FSPDRIVE#yyyy-mm-dd.xml</i>
CIFX 104C-RE\F\M12		
CIFX 104C-RE-R\F	 Note! If you use a Sercos Master which is using SDDML files for configuration, and one of the defaults for vendor code, device ID, input data size or output data size was changed, then you have to export a new updated SDDML file from SYCON.net and import this SDDML file into the configuration software for the Sercos Master.	
CIFX 104C-RE-R\F\M12		

Table 14: Device Description Files for PC Cards cifX Real-Time-Ethernet

Fieldbus

PC Cards cifX	System	File Name of the Device Description File
CIFX 80-DP CIFX 90-DP\F CIFX 90E-DP\F CIFX 90E-DP\NHS\F CIFX 90E-DP\ET\F CIFX 90E-DP\MR\F CIFX 90E-DP\MR\ET\F CIFX 90E-2DP\ET\F CIFX 90E-2DP\MR\ET\F CIFX 104C-DP CIFX 104C-DP-R CIFX 104C-DP\F CIFX 104C-DP-R\F	PROFIBUS DP Slave	<i>HIL_0B69.GSD</i>
CIFX 90E-2DP\CO\ET\F CIFX 90E-2DP\CO\MR\ET\F	PROFIBUS DP Slave CANopen Slave	<i>HIL_0B69.GSD</i> <i>CIFX CO COS.eds</i>
CIFX 90E-2DP\DN\ET\F CIFX 90E-2DP\DN\MR\ET\F	PROFIBUS DP Slave DeviceNet Slave	<i>HIL_0B69.GSD</i> <i>CIFX_DN_DNS.EDS</i>
CIFX 80-CO CIFX 90-CO\F CIFX 90E-CO\F CIFX 90E-CO\NHS\F CIFX 90E-CO\ET\F CIFX 90E-CO\MR\F CIFX 90E-CO\MR\ET\F CIFX 90E-2CO\ET\F CIFX 90E-2CO\MR\ET\F CIFX 104C-CO CIFX 104C-CO-R CIFX 104C-CO\F CIFX 104C-CO-R\F	CANopen-Slave	<i>CIFX CO COS.eds</i>
CIFX 90E-2CO\DN\ET\F CIFX 90E-2CO\DN\MR\ET\F	CANopen Slave DeviceNet Slave	<i>CIFX CO COS.eds</i> <i>CIFX_DN_DNS.EDS</i>
CIFX 80-DN CIFX 90-DN\F CIFX 90E-DN\F CIFX 90E-DN\NHS\F CIFX 90E-DN\ET\F CIFX 90E-DN\MR\F CIFX 90E-DN\MR\ET\F CIFX 90E-2DN\ET\F CIFX 90E-2DN\MR\ET\F CIFX 104C-DN CIFX 104C-DN-R CIFX 104C-DN\F CIFX 104C-DN-R\F	DeviceNet Slave	<i>CIFX_DN_DNS.EDS</i>
CIFX 90-CC\F CIFX 90E-CC\NHS\F CIFX 90E-CC\ET\F CIFX 90E-CC\MR\ET\F CIFX 104C-CC\F	CC-Link Slave	<i>0x0352_CIFX-CCS_2.11_en.cspp,</i> <i>0x0352_CIFX-CCS_2.11_en.cspproj</i>

Table 15: Device Description Files for PC Cards cifX Fieldbus

2.7 Revision or version status of hardware and software



Note on Software Update: The hardware revisions and the versions for the firmware, the driver or the configuration software listed in this section functionally belong together. For existing hardware installation the firmware, the driver and the configuration software must be updated according to the details listed in this section.

For the software upgrade system overview refer to section *Update for Firmware, Driver and Software* on page 97.

2.7.1 Hardware: PC Cards cifX

PC Card cifX , AIFX	Part No.	Hardware Revision	USB from HW Rev.	„DMA Mode“ from HW Rev.
CIFX 80-RE	1280.100	3	1	1
CIFX 90-RE\F ¹	1290.100	4	-	1
CIFX 90-RE\F\M12 ⁷	1290.120	4	-	1
CIFX 90E-RE\F ^{1,8}	1291.100	B	-	A
CIFX 90E-RE\F\M12 ^{7,8}	1291.120	B	-	A
CIFX 90E-RE\NHS\F ^{1,8}	1291.108	1	-	1
CIFX 90E-RE\NHS\F\M12 ^{7,8}	1291.128	1	-	1
CIFX 90E-RE\ET\F ^{1,8}	1291.104	1	-	1
CIFX 90E-RE\ET\F\M12 ^{7,8}	1291.124	1	-	1
CIFX 90E-RE\MR\F ^{1,8}	1291.102	B	-	B
CIFX 90E-RE\MR\F\M12 ^{7,8}	1291.122	B	-	B
CIFX 90E-RE\MR\ET\F ^{1,8}	1291.106	1	-	1
CIFX 90E-RE\MR\ET\F\M12 ^{7,8}	1291.126	1	-	1
CIFX 104C-RE	1270.100	5	1	1
CIFX 104C-RE-R	1271.100	5	1	1
CIFX 104C-RE\F ¹	1270.101	5	5 ⁶	1
CIFX 104C-RE\F\M12 ⁷	1270.121	5	5 ⁶	1
CIFX 104C-RE-R\F ¹	1271.101	5	5 ⁶	1
CIFX 104C-RE-R\F\M12 ⁷	1271.121	5	5 ⁶	1
CIFX 80-DP	1280.410	3	1	1
CIFX 80-CO	1280.500	3	1	1
CIFX 80-DN	1280.510	3	1	1
CIFX 90-DP\F ^{2,9}	1290.410	4	-	1
CIFX 90-CO\F ^{3,9}	1290.500	4	-	1
CIFX 90-DN\F ^{4,9}	1290.510	4	-	1
CIFX 90-CC\F ⁵	1290.740	4	-	1
CIFX 90E-DP\F ^{2,9}	1291.410	B	-	A
CIFX 90E-DP\NHS\F ^{2,9}	1291.418	1	-	1
CIFX 90E-DP\ET\F ^{2,9}	1291.414	1	-	1
CIFX 90E-DP\MR\F ^{2,9}	1291.412	B	-	B
CIFX 90E-DP\MR\ET\F ^{2,9}	1291.416	1	-	1
CIFX 90E-CO\F ^{3,9}	1291.500	B	-	A
CIFX 90E-CO\NHS\F ^{3,9}	1291.508	1	-	1
CIFX 90E-CO\ET\F ^{3,9}	1291.504	1	-	1
CIFX 90E-CO\MR\F ^{3,9}	1291.502	B	-	B
CIFX 90E-CO\MR\ET\F ^{3,9}	1291.506	1	-	1
CIFX 90E-DN\F ^{4,9}	1291.510	B	-	A
CIFX 90E-DN\NHS\F ^{4,9}	1291.518	1	-	1

¹ inclusively detached network interface Ethernet (AIFX-RE)

² inclusively detached network interface PROFIBUS (AIFX-DP)

³ inclusively detached network interface

PC Card cifX , AIFX	Part No.	Hardware Revision	USB from HW Rev.	„DMA Mode“ from HW Rev.	
CIFX 90E-DN\ET\F ^{4,9}	1291.514	1	-	1	CANopen (AIFX-CO)
CIFX 90E-DN\MR\F ^{4,9}	1291.512	B	-	B	⁴ inclusively detached network interface DeviceNet (AIFX-DN)
CIFX 90E-DN\MR\ET\F ^{4,9}	1291.516	1	-	1	
CIFX 90E-CC\NHS\F ⁵	1291.748	1	-	1	⁵ inclusively detached network interface CC-Link (AIFX-CC)
CIFX 90E-CC\ET\F ⁵	1291.744	1	-	1	
CIFX 90E-CC\MR\ET\F ⁵	1291.746	1	-	1	
CIFX 90E-2DP\ET\F ^{2,9}	1293.414	2	1	1	⁶ only when using the detached network interface diagnostic (AIFX-DIAG)
CIFX 90E-2DP\MR\ET\F ^{2,9}	1293.416	2	1	1	
CIFX 90E-2DP\CO\ET\F ^{2,3,9}	1293.474	2	1	1	⁷ inclusively detached network interface Ethernet M12 (AIFX-REM12)
CIFX 90E-2DP\CO\MR\ET\F ^{2,3,9}	1293.476	2	1	1	
CIFX 90E-2DP\DN\ET\F ^{2,4,9}	1293.484	2	1	1	
CIFX 90E-2DP\DN\MR\ET\F ^{2,4,9}	1293.486	2	1	1	
CIFX 90E-2CO\ET\F ^{3,9}	1293.504	2	1	1	⁸ optionally available with 20 cm cable; part number is extended by „/20“
CIFX 90E-2CO\MR\ET\F ^{3,9}	1293.506	2	1	1	
CIFX 90E-2DN\ET\F ^{4,9}	1293.514	2	1	1	
CIFX 90E-2DN\MR\ET\F ^{4,9}	1293.516	2	1	1	
CIFX 90E-2CO\DN\ET\F ^{3,4,9}	1293.574	2	1	1	⁹ optionally available with 30 cm cable; part number is extended by „/30“
CIFX 90E-2CO\DN\MR\ET\F ^{3,4,9}	1293.576	2	1	1	
CIFX 104C-DP	1270.410	2	1	1	
CIFX 104C-DP-R	1271.410	2	1	1	
CIFX 104C-DP\F ^{2,9}	1270.411	2	1 ⁶	1	
CIFX 104C-DP-R\F ^{2,9}	1271.411	2	1 ⁶	1	
CIFX 104C-CO	1270.500	2	1	1	
CIFX 104C-CO-R	1271.500	2	1	1	
CIFX 104C-CO\F ^{3,9}	1270.501	2	1 ⁶	1	
CIFX 104C-CO-R\F ^{3,9}	1271.501	2	1 ⁶	1	
CIFX 104C-DN	1270.510	2	1	1	
CIFX 104C-DN-R	1271.510	2	1	1	
CIFX 104C-DN\F ^{4,9}	1270.511	2	1 ⁶	1	
CIFX 104C-DN-R\F ^{4,9}	1271.511	2	1 ⁶	1	
CIFX 104C-CC\F ⁵	1270.741	2	1 ⁶	1	

Table 16: Reference on Hardware PC Cards cifX

2.7.2 Hardware: Product Components for PC Cards cifX

Basic Cards cifX, AIFX	Part No.	Hardware Revision	USB from HW Rev.	„DMA Mode“ from HW Rev.
CIFX 90	1290.101	4	-	1
CIFX 90E	1291.101	B	-	A
CIFX 90E\NHS	1291.109	1	-	1
CIFX 90E\ET	1291.105	1	-	1
CIFX 90E\MR	1291.103	B	-	B
CIFX 90E\MR\ET	1291.107	1	-	1
CIFX 90E-2FB\ET	1293.005	2	1	1
CIFX 90E-2FB\MR\ET	1293.007	2	1	1
AIFX-RE	2800.100	2	-	-
AIFX-RE\M12	2800.101	2	-	-
AIFX-DP ⁹	2800.400	2	-	-
AIFX-CO ⁹	2800.500	2	-	-
AIFX-DN ⁹	2800.510	3	-	-
AIFX-CC	2800.730	2	-	-
AIFX-DIAG	2800.000	2	-	-

⁹ optionally available with 30 cm cable; part number is extended by „/30“

Table 17: Reference on Hardware: Basic Cards for PC Cards cifX, detached Network Interfaces AIFX

The basic cards CIFX 90, CIFX 90E, CIFX 90E\NHS, CIFX 90E\ET, CIFX 90E\MR, CIFX 90E\MR\ET, CIFX 90E-2FB\ET and CIFX 90E-2FB\MR\ET can be combined with a detached network interface AIFX (refer also to page *The Label „F“ in the Device Name* on page 13).

The technical specifications in this manual refer to the fully assembled PC cards cifX with the respective detached network interface.

2.7.3 Firmware

Protocol	Firmware File	Firmware Version*	Minimum Version of the Firmware for USB Support
CANopen Master	CIFXCOM.NXF	2.14	from 2.5.2.0
CANopen Slave	CIFXCOS.NXF	3.8	from 2.4.4.0
CC-Link Slave	CIFXCCS.NXF	2.13	-
CC-Link IE Field Basic Slave	C020Y000.NXF	1.1	-
DeviceNet Master	C0206000.NXF	2.4	from 2.2.7.0
DeviceNet Slave	CIFXDNS.NXF	2.7	from 2.2.7.0
EtherCAT Master	CIFXECM.NXF	4.5 (V4)	from 2.4.4.0
EtherCAT Slave	CIFXECS.NXF	4.8 (V4)	from 2.5.13.0
EtherNet/IP Scanner	CIFXEIM.NXF	2.11	from 2.2.4.1
EtherNet/IP-Adapter	C010H000.NXF	3.6 (V3)	from 2.3.4.1
Open-Modbus/TCP	CIFXOMB.NXF	2.7	from 2.3.2.1
POWERLINK Controlled Node	C010K000.NXF	3.4 (V3)	from 2.1.22.0
PROFIBUS DP Master	CIFXDPM.NXF	2.8	from 2.3.22.0
PROFIBUS DP Slave	CIFXDPS.NXF	2.11	from 2.3.30.0
PROFIBUS MPI-Gerät	CIFXMPI.NXF	2.4	from 2.4.1.2
PROFINET IO-Controller	C010C000.NXF	3.4 (V3)	from 2.4.10.0
PROFINET IO-Device	C010D000.NXF	4.5 (V4)	from 3.4.9.0
Sercos Master	CIFXS3M.NXF	2.1	from 2.0.14.0
Sercos Slave	CIFXS3S.NXF	3.5	from 3.0.13.0
VARAN-Client	CIFXVRS.NXF	1.1	from 1.0.3.0

Table 18: Reference on Firmware (for 1 Channel Systems)



Note: *Unless otherwise indicated, in this manual data to the firmware version correspond to the stack version.

The downloadable cifX firmware runs on PC Cards *cifX Compact PCI, Mini PCI, Mini PCI Express and PCI-104*. The firmware automatically detects whether it is running on a PC Cards *cifX Compact PCI, Mini PCI, Mini PCI Express and PCI-104*.

PC Cards Mini PCI Express with two Channels:

Protocol Channel X1	Stack-Version	Protocol Channel X2	Stack-Version	Firmware File	Firmware Version
CANopen Master	2.14	CANopen Master	2.14	C0204040.NXF	1.2
CANopen Master	2.14	CANopen Slave	3.7	C0204050.NXF	1.2
CANopen Master	2.14	DeviceNet Master	2.4	C0204060.NXF	1.2
CANopen Slave	3.7	CANopen Slave	3.7	C0205050.NXF	1.2
CANopen Slave	3.7	DeviceNet Slave	2.5	C0205070.NXF	1.2
DeviceNet Master	2.4	DeviceNet Master	2.4	C0206060.NXF	1.2
DeviceNet Master	2.4	DeviceNet Slave	2.5	C0206070.NXF	1.2
DeviceNet Slave	2.5	DeviceNet Slave	2.5	C0207070.NXF	1.2
PROFIBUS DP Master	2.9	PROFIBUS DP-Master	2.9	CIFX2DPM.NXF	1.2 (new version counting)
PROFIBUS DP Master	2.9	PROFIBUS DP-Slave	2.9	C0201020.NXF	1.2
PROFIBUS DP Master	2.9	CANopen Master	2.14	C0201040.NXF	1.2
PROFIBUS DP Master	2.9	DeviceNet Master	2.4	C0201060.NXF	1.2
PROFIBUS DP Slave	2.9	PROFIBUS DP-Slave	2.9	CIFX2DPS.NXF	1.1 (new version counting)
PROFIBUS DP Slave	2.9	CANopen Slave	3.7	C0202050.NXF	1.2
PROFIBUS DP Slave	2.9	DeviceNet Slave	2.5	C0202070.NXF	1.2

Table 19: Reference on Firmware (for 2 Channel Systems)

2.7.4 Driver and Software

Driver and Software	Version
SYCON.net SYCONnet netX setup.exe	1.0500
netX Configuration Tool-Setup netXConfigurationUtility_Setup.exe	1.0900
cifX Device Driver cifX Device Driver Setup.exe	1.5
Toolkit	1.6
cifX TCP/IP Server for SYCON.net cifX TCP Server.exe	V2.3
US Driver USB Driver of Windows®	5.1.2600.x

Table 20: Reference on Driver and Software

2.8 Device Label with Matrix or Bar Code

You can identify your device by means of the device label.



Note: The position of the device label on your device can be seen from the device drawing.

The device label consists of a matrix code or bar code and the information contained therein in plain text.

The 2 D code (Data Matrix Code) contains the following information:

- ① Part number: 1234.567
- ② Hardware revision: 1
- ③ Serial number: 20000 (for mini matrix 20001)

The device label with matrix code can be designed as mini-sticker.

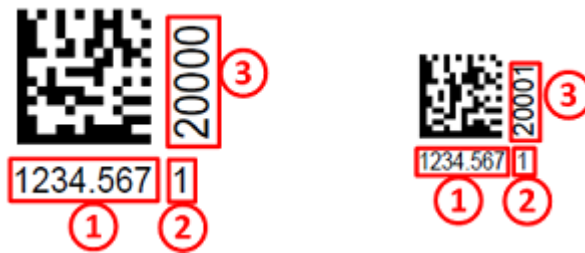

Figure 1: Example 2D Label (mini sticker on the right)

The bar code (EAN 39) contains the following information:

- ① Part number: 1234.567
- ② Hardware revision: 1
- ③ Serial number: 20002
- ④ Security code: X



Figure 2: Example Barcode Label (EAN 39)

3 Device Drawings

3.1 PC Cards cifX Compact PCI

3.1.1 CIFX 80-RE

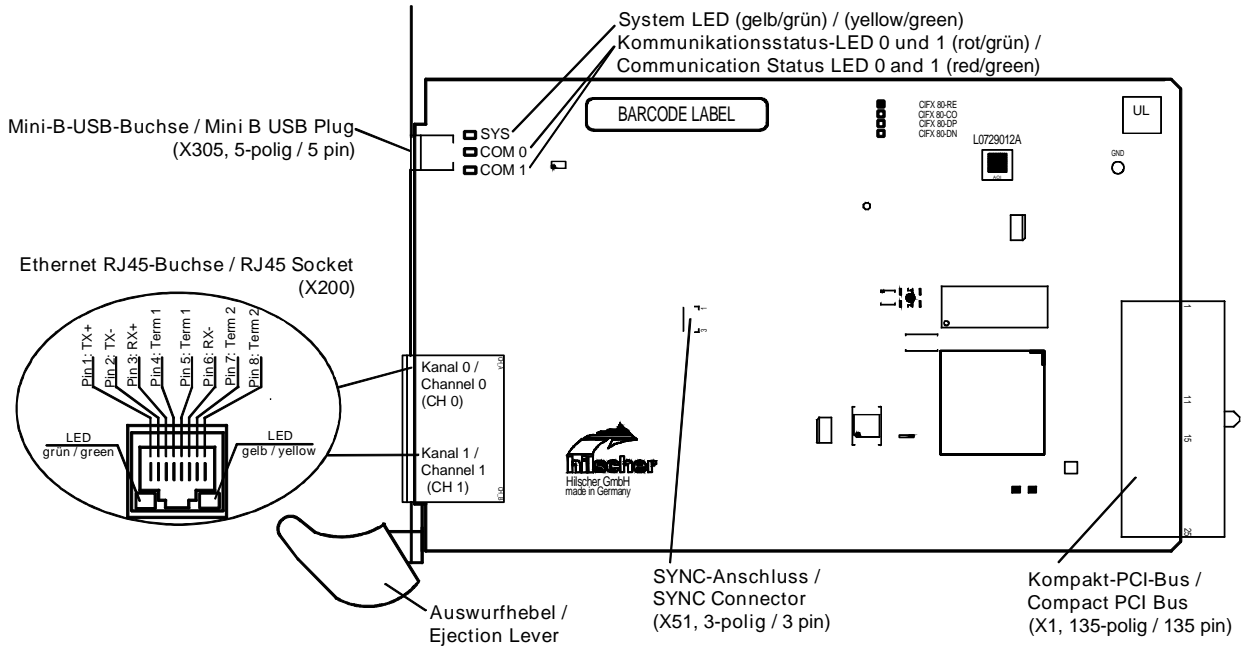

Figure 3: CIFX 80-RE*



Note: *Device supports Auto Crossover Function.

The figure below shows the front plate of the PC cards CIFX 80-RE:

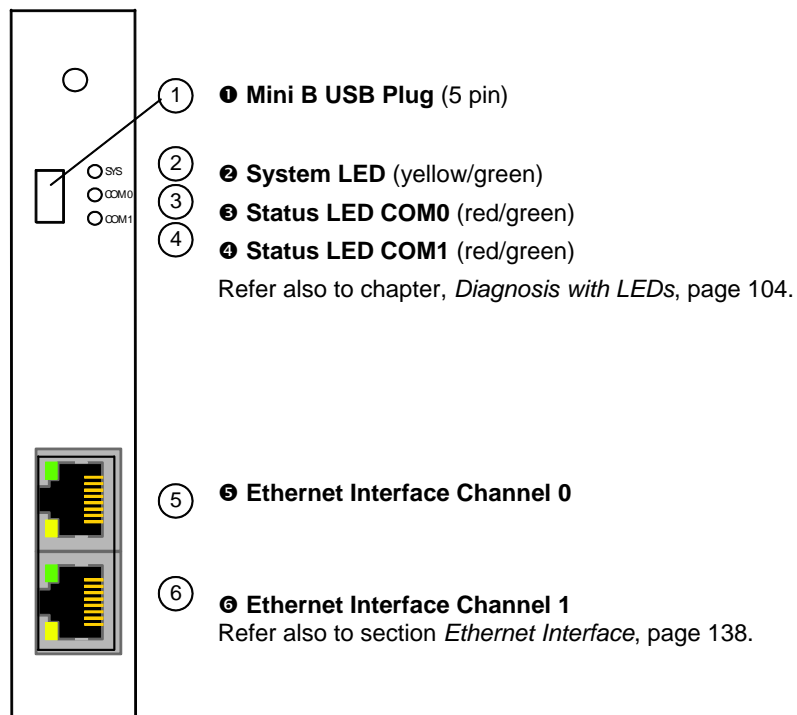

Figure 4: Front Plate CIFX 80-RE

3.1.2 CIFX 80-DP

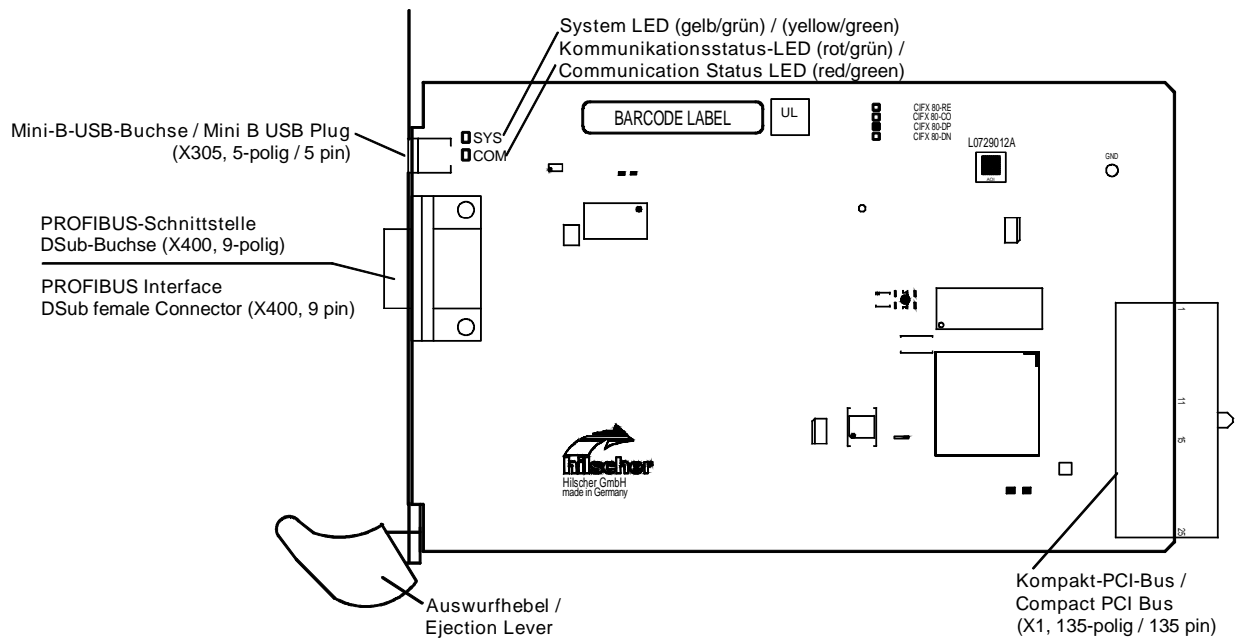

Figure 5: CIFX 80-DP

The figure below shows the front plate of the PC cards CIFX 80-DP:

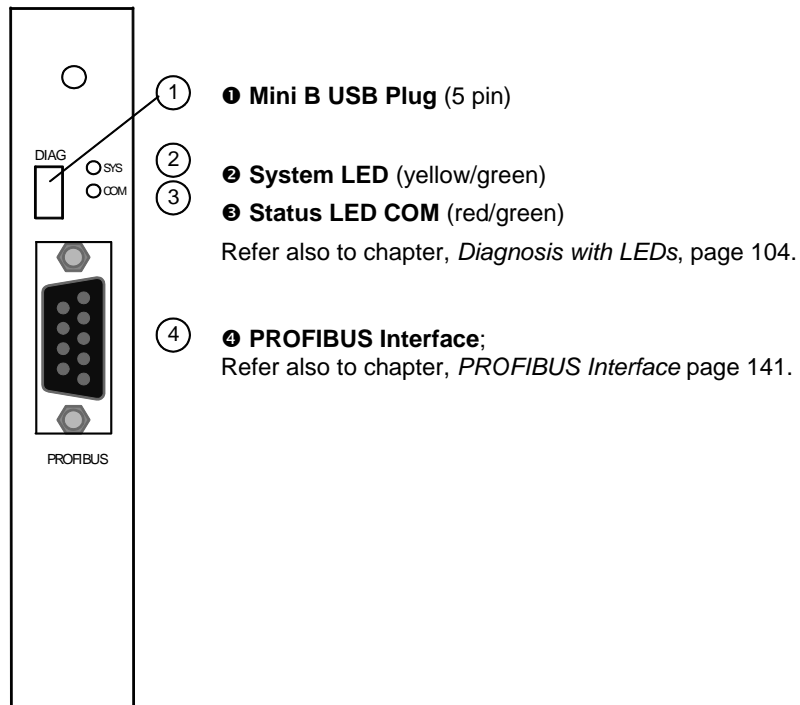

Figure 6: Front Plate CIFX 80-RE

3.1.3 CIFX 80-CO

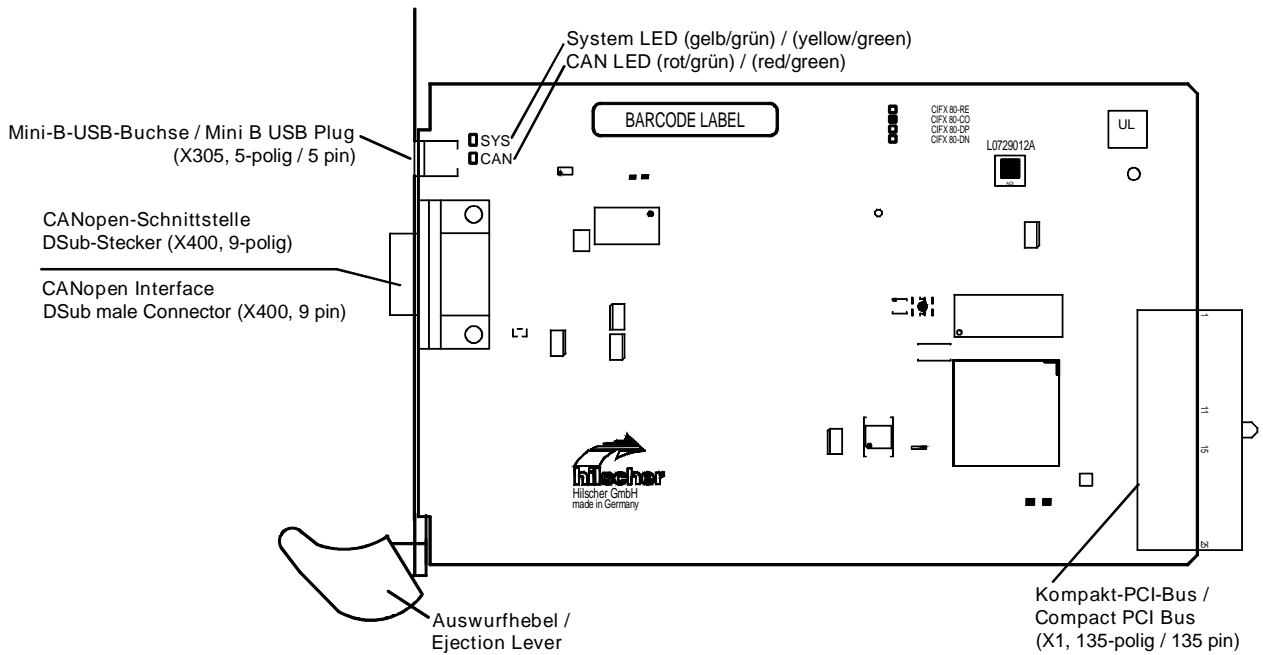

Figure 7: CIFX 80-CO

The figure below shows the front plate of the PC cards CIFX 80-CO:

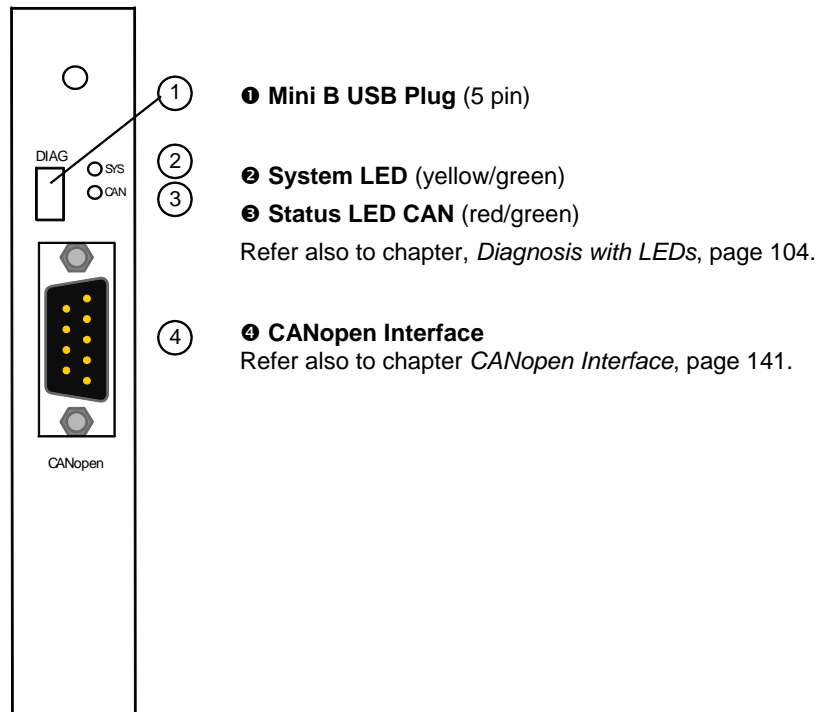

Figure 8: Front Plate CIFX 80-CO

3.1.4 CIFX 80-DN

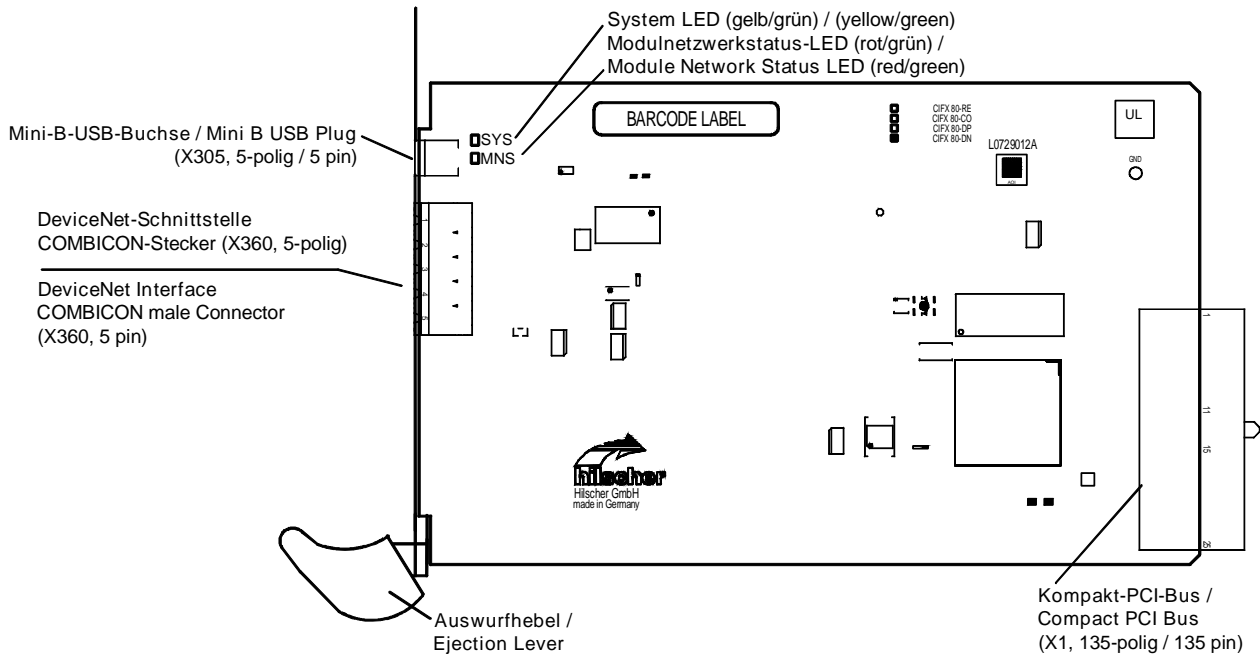

Figure 9: CIFX 80-DN



For the pin assignment of the **SYNC** Connector refer to section *Pin Assignment SYNC Connector, X51* on page 154. For further information on the **Mini-B USB** Connector refer to section *Mini-B USB Connector (5 Pin)* on page 143.



Note: The front plate cutout for the CombiCon male Connector is at the PCB side 0.5 mm outside of the standard front plate cutout.

The figure below shows the front plate of the PC cards CIFX 80-DN:

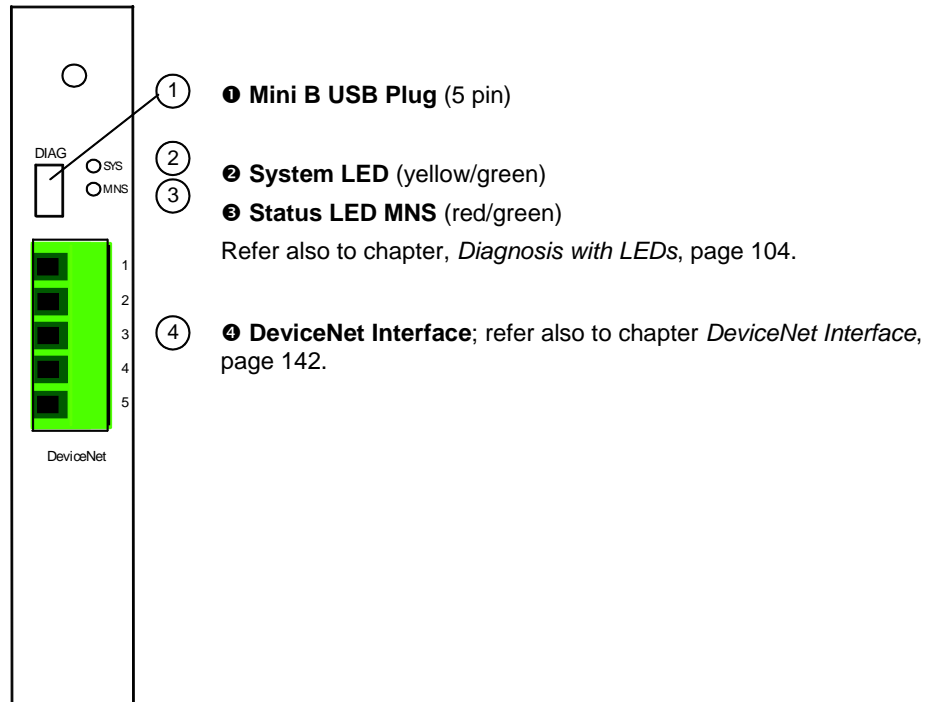

Figure 10: Front Plate CIFX 80-DN

3.2 PC Cards cifX Mini PCI and Mini PCI Express

3.2.1 CIFX 90-REV, CIFX 90E-REV and Variants

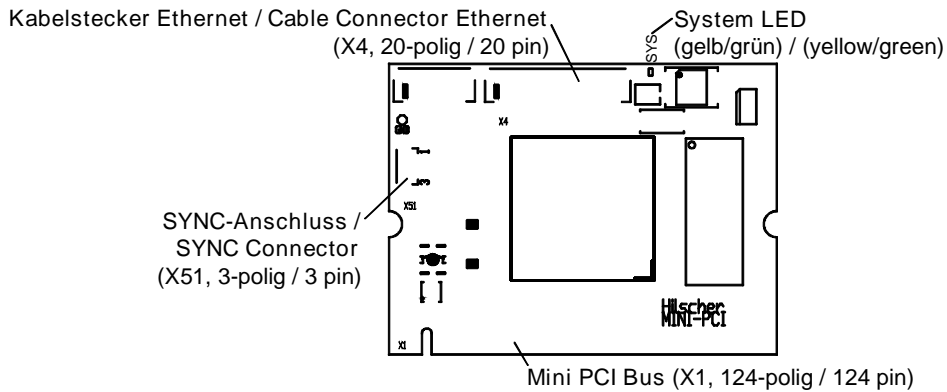

Figure 11: Basic Card CIFX 90 for CIFX 90-REV* or for CIFX 90-REVM12*

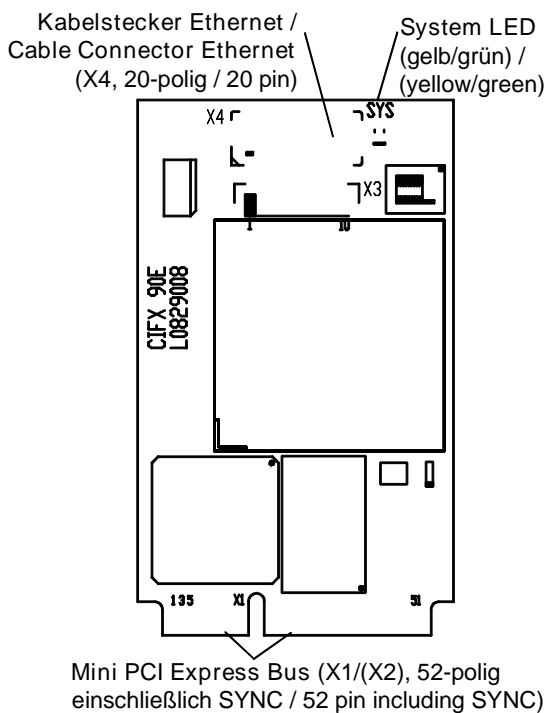

Figure 12: identical looking basic cards CIFX 90E for variants -REV*, -RE\NHS\F*, -RE\ET\F* or for corresponding M12 variants*

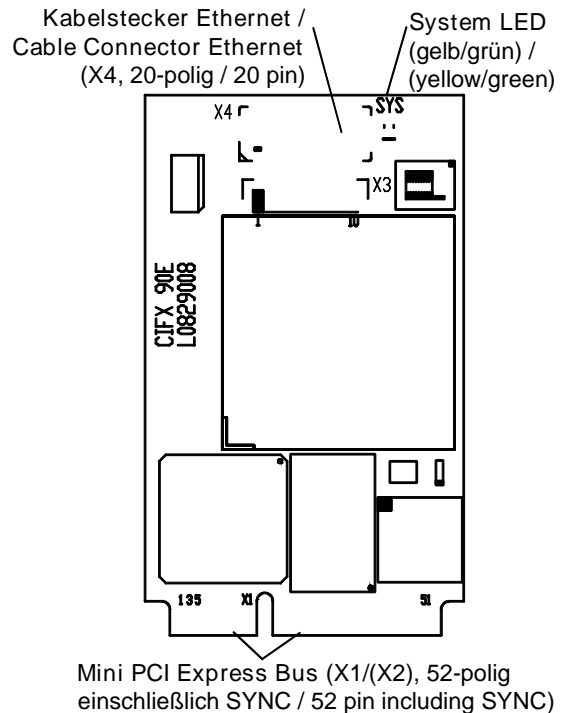

Figure 13: identical looking basic cards CIFX 90E for variants -RE\MR\F*, -RE\MR\ET\F* or for corresponding M12 variants*



Notes: *Device supports Auto Crossover Function.

The cable connector Ethernet X4 is white colored.

The matrix label is positioned on the reverse side of the card, refer to section *Reverse Side CIFX 90-XX\F, CIFX 90E-XX\F and Variants* on page 40.



For the **pin assignment**

- of the **Mini PCI** bus refer to section *Pin Assignment for Mini PCI Bus, X1* on page 156 or
- of the **Mini PCI Express** bus to section *Pin Assignment for Mini PCI Express Bus / SYNC Connector (Bootstart), X1/X2* on page 158 or

- of the **SYNC** Connector: (1) Of PC cards CIFX 90-REV to section *Pin Assignment SYNC Connector, X51* on page 154.

- (2) For the PC cards CIFX 90E-REV, CIFX 90E-RE\NHS\F, CIFX 90E-RE\ET\F, CIFX 90E-RE\MR\F and CIFX 90E-RE\MR\ET\F and for the corresponding M12 variants the SYNC pins are on the Mini PCI Express bus (Pin 46, 44), refer to section *Pin Assignment for Mini PCI Express Bus / SYNC Connector (Bootstart), X1/X2*, on page 158.

For information on the **card height** refer to section the *Notes on the Card Height - PC Card cifX Mini PCI and Mini PCIe* on page 64.

3.2.2 CIFX 90-FB\F, CIFX 90E-FB\F and Variants

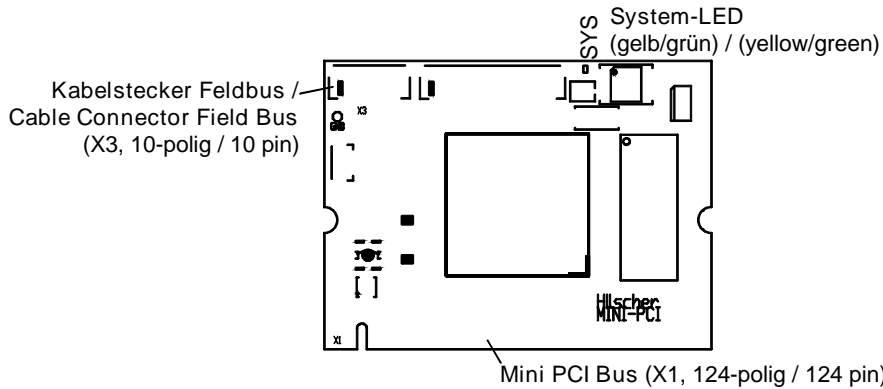

Figure 14: Basic Card CIFX 90 for CIFX 90-DPVF, CIFX 90-COVF, CIFX 90-DNVF F, CIFX 90-CCVF

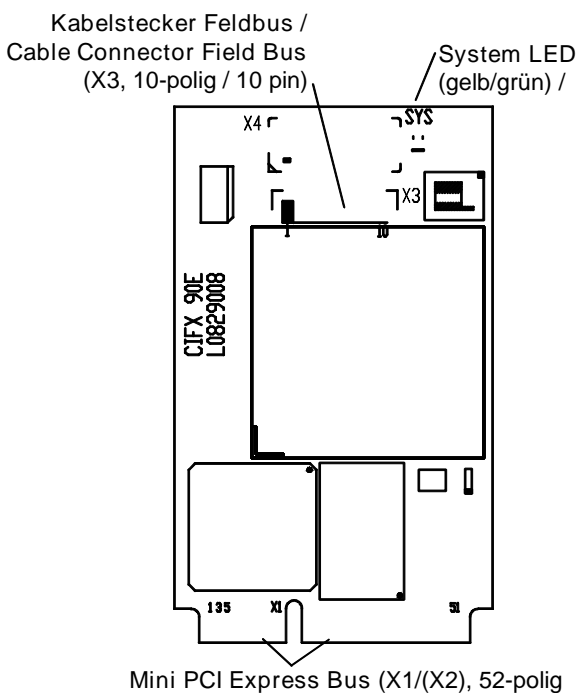

Figure 15: identical looking basic Cards CIFX 90E, CIFX 90EWHS, CIFX 90E\ET (for CIFX 90E-FB\F, CIFX 90E-FB\WHS\F and CIFX 90E-FB\ET\F)

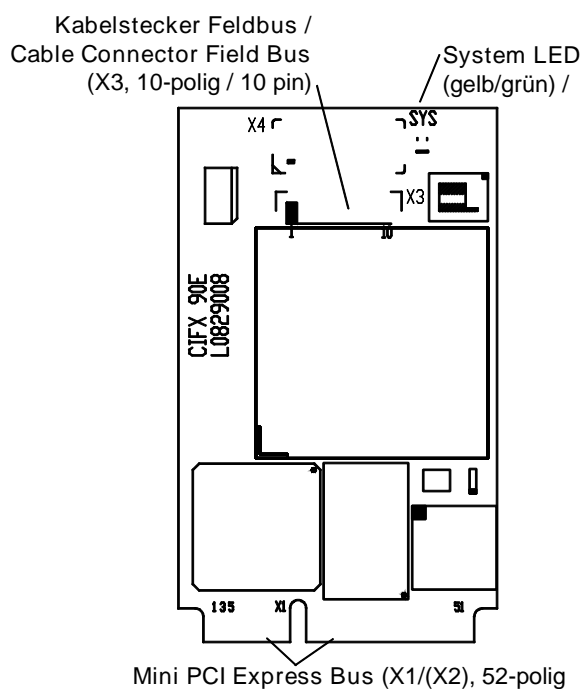

Figure 16: identical looking basic Cards CIFX 90EWR, CIFX 90EWR\ET (for CIFX 90E-FB\WR\F, or CIFX 90E-FB\WR\ET\F)



Notes: The cable connector fieldbus X3 is black colored.

The matrix label is positioned on the reverse side of the card, refer to section *Reverse Side CIFX 90-XX\F, CIFX 90E-XX\F and Variants* on page 40.



For the **pin assignment**

- of the **Mini PCI** bus refer to section *Pin Assignment for Mini PCI Bus, X1* on page 156 or
- of the **Mini PCI Express** bus to section *Pin Assignment for Mini PCI Express Bus / SYNC Connector (Bootstart), X1/X2* on page 158 or for information on the **card height** refer to section the *Notes on the Card Height - PC Card cifX Mini PCI and Mini PCIe* on page 64.

3.2.3 CIFX 90E-2FB\ET\F and CIFX 90E-2FB\MR\ET\F

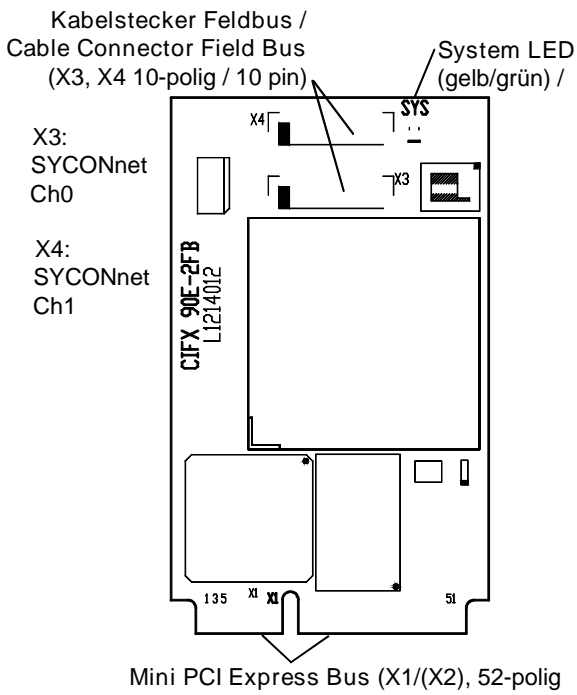

Figure 17: Basic Card CIFX 90E-2FB\ET\F for CIFX 90E-2FB\ET\F

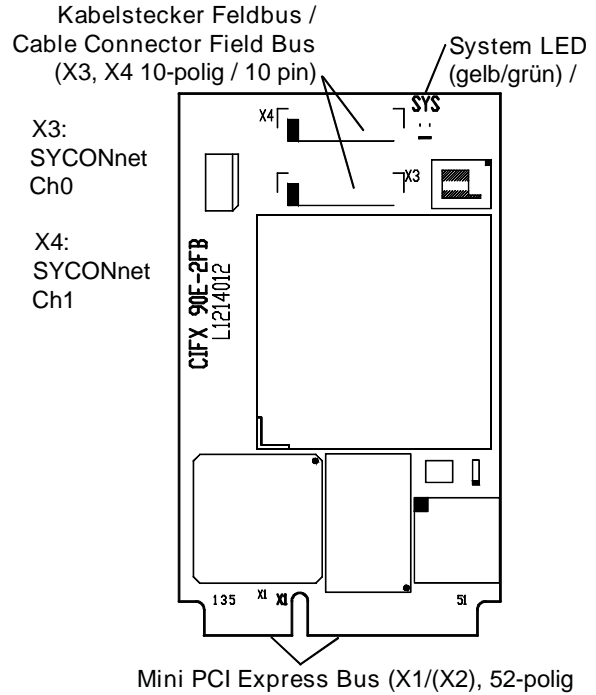

Figure 18: Basic Card CIFX 90E-2FB\MR\ET\F for CIFX 90E-2FB\MR\ET\F



Notes: The cable connectors fieldbus X3 and X4 are black colored.
The matrix label is positioned on the reverse side of the card, refer to section *Reverse Side CIFX 90-XX\F, CIFX 90E-XX\F and Variants* on page 40.



For the **pin assignment** of the **Mini PCI Express** bus to section *Pin Assignment for Mini PCI Express Bus / SYNC Connector (Bootstart), X1/X2* on page 158 or for information on the **card height** refer to section the *Notes on the Card Height - PC Card cifX Mini PCI and Mini PCIe* on page 64.

3.2.4 Reverse Side CIFX 90-XX\F, CIFX 90E-XX\F and Variants

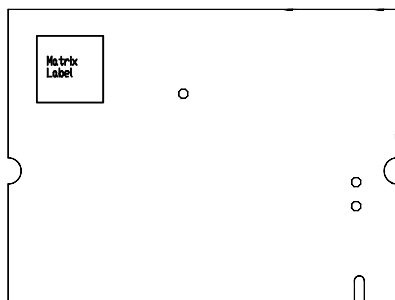

Figure 19: Reverse Side CIFX 90-XX\F

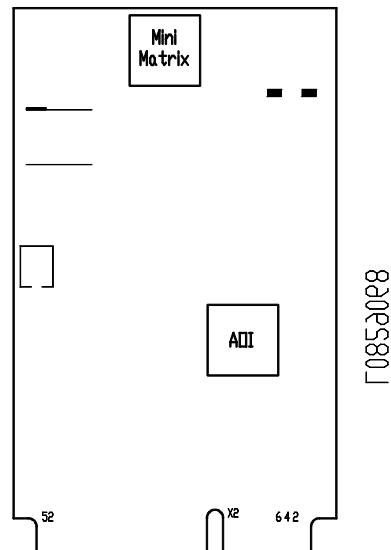

Figure 20: Reverse Side CIFX 90E-XX\F

3.3 PC Cards cifX PCI-104

3.3.1 CIFX 104C-RE, CIFX 104C-RE-R

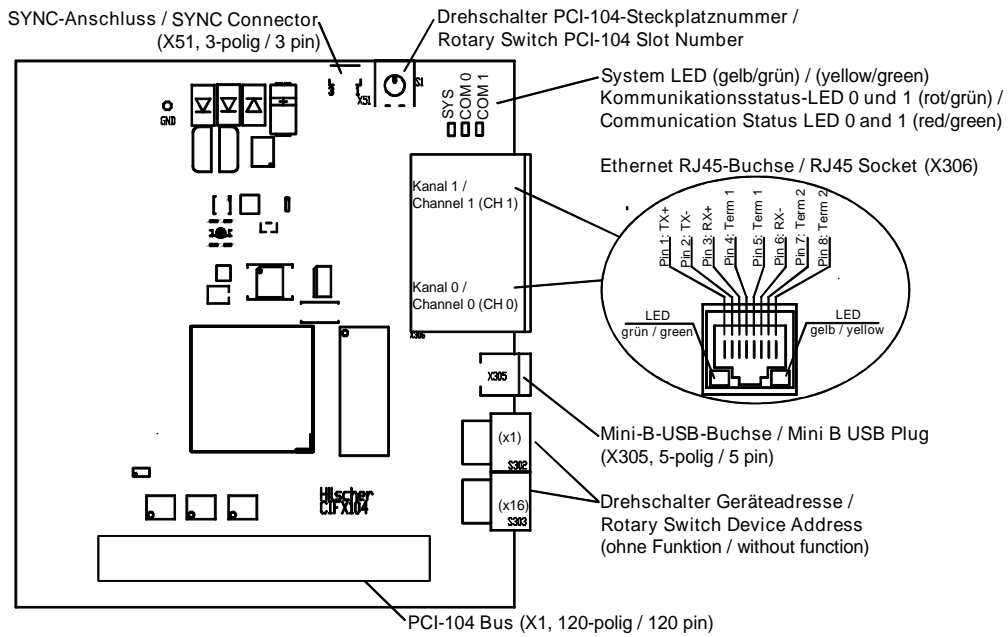

Figure 21: CIFX 104C-RE*

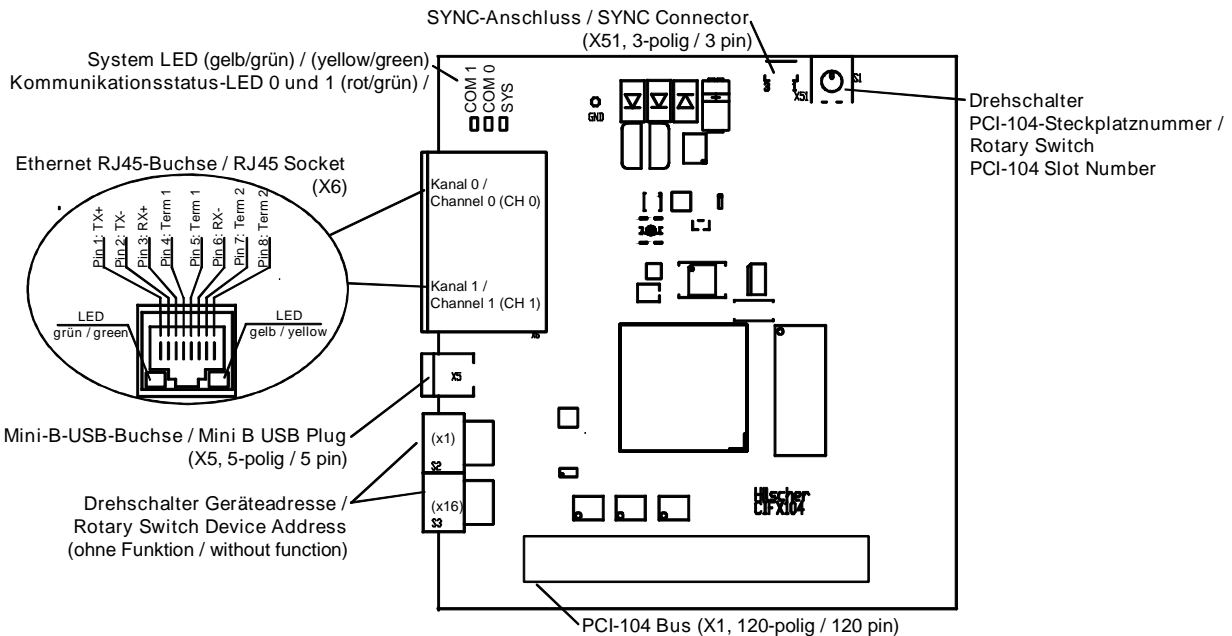

Figure 22: CIFX 104C-RE-R*



Note: *Device supports Auto Crossover Function.



The meaning of the **LEDs** depends from the loaded firmware. See chapter *Diagnosis with LEDs* beginning from page 104.

For the pin assignment of the SYNC Connector refer to section *Pin Assignment SYNC Connector, X51* on page 154. For further information on the **Mini-B USB** Connector refer to section *Mini-B USB Connector (5 Pin)* on page 143.

3.3.2 CIFX 104C-RE\F, CIFX 104C-RE-R\F

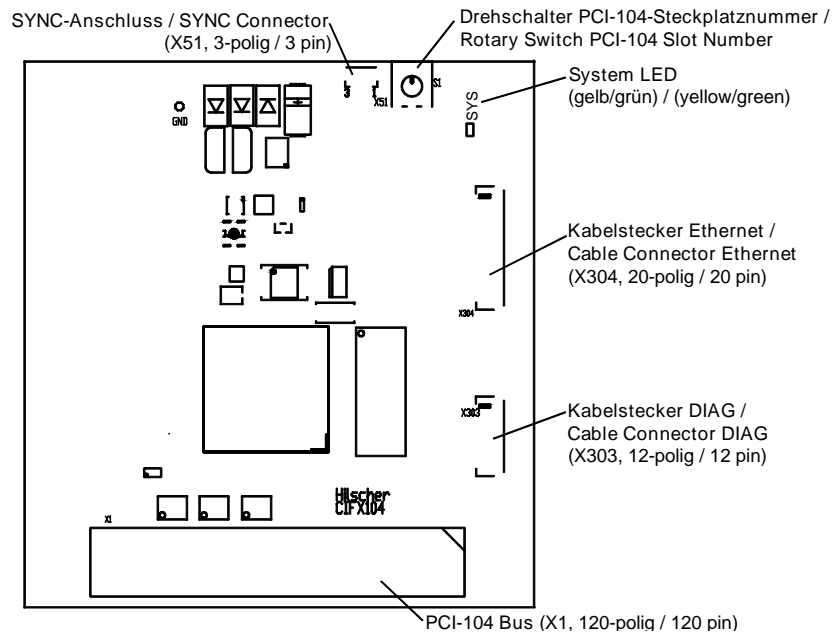

Figure 23: Basic Card for CIFX 104C-RE\F

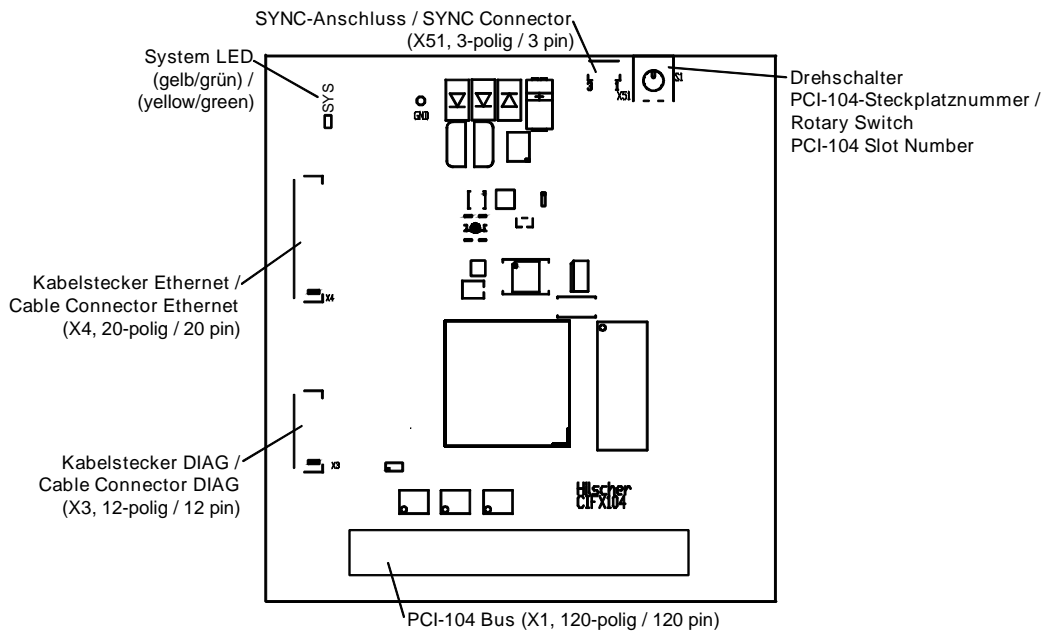

Figure 24: Basic Card for CIFX 104C-RE-R\F



For the **SYNC** pin assignment of the SYNC Connector refer to section *Pin Assignment SYNC Connector, X51* on page 154.



Note: If the **AIFX-DIAG** diagnostic detached network interface is connected to the basic card for the PC card CIFX 104C-RE\F or CIFX 104C-RE-R\F, the **Mini-B USB** connector on the AIFX-DIAG can be used beginning with the hardware revision 5 of the PC card cifX.

3.3.3 CIFX 104C-DP, CIFX 104C-DP-R

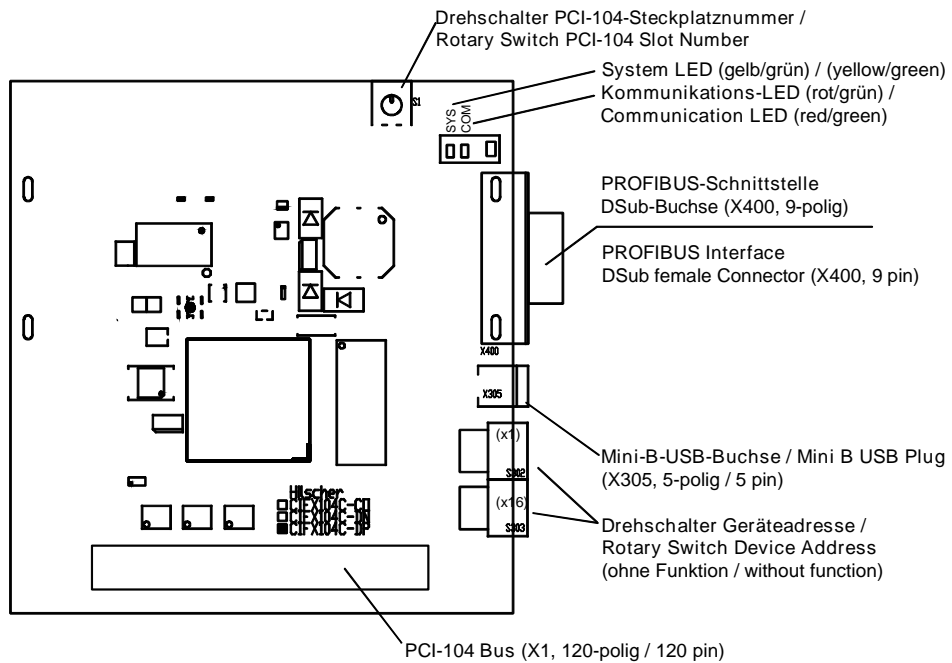

Figure 25: CIFX 104C-DP

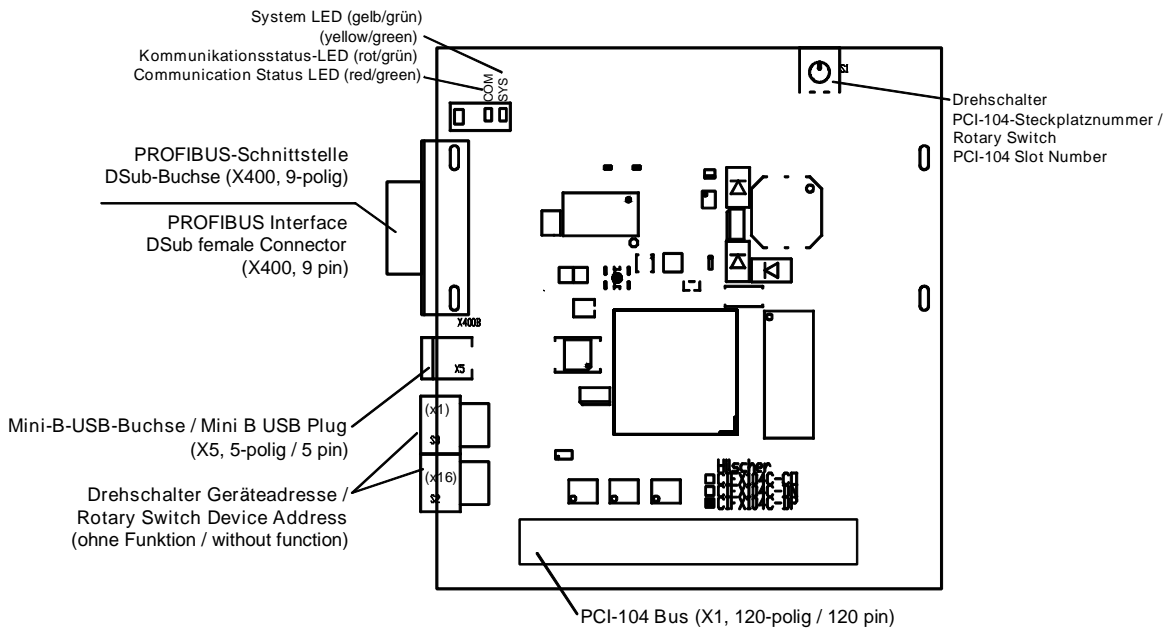

Figure 26: CIFX 104C-DP-R



For further information on the **Mini-B USB Connector** refer to section *Mini-B USB Connector (5 Pin)* on page 143.

3.3.4 CIFX 104C-CO, CIFX 104C-CO-R

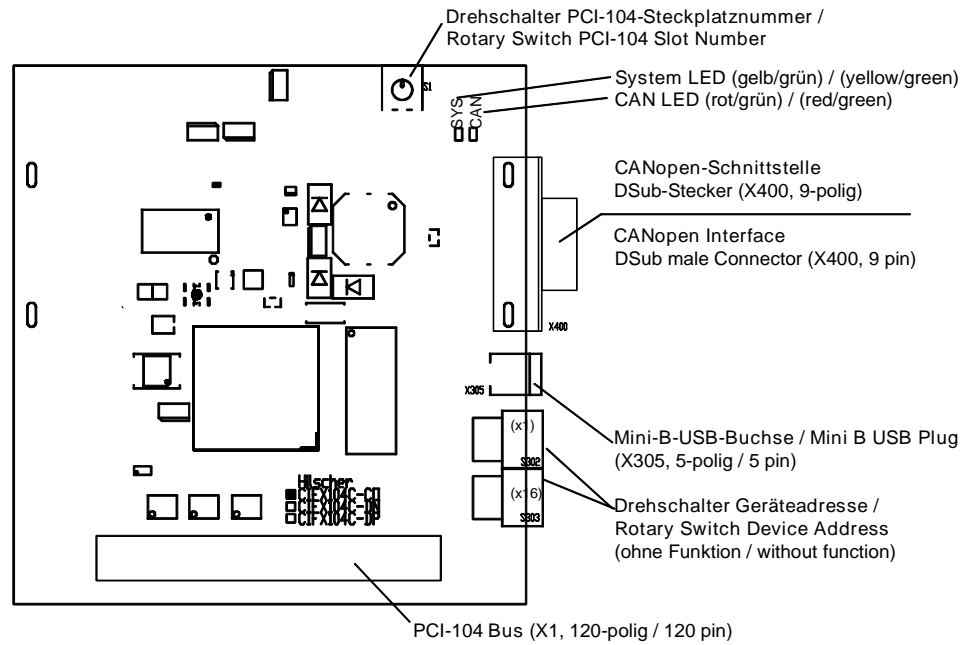

Figure 27: CIFX 104C-CO

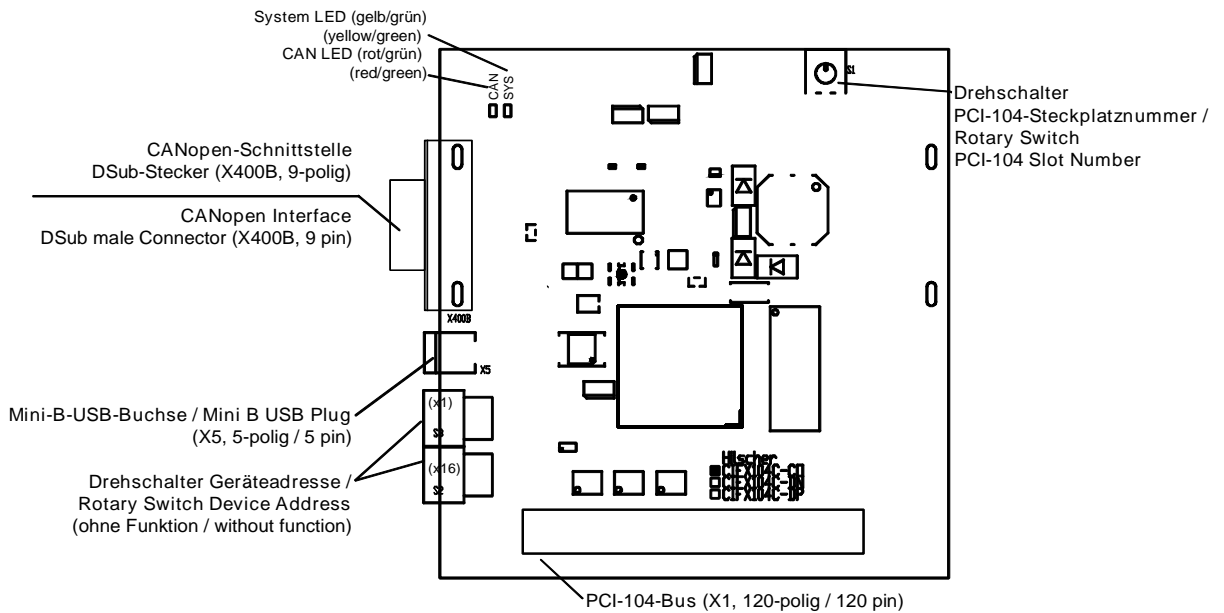

Figure 28: CIFX 104C-CO-R



For further information on the **Mini-B USB** Connector refer to section *Mini-B USB Connector (5 Pin)* on page 143.

3.3.5 CIFX 104C-DN, CIFX 104C-DN-R

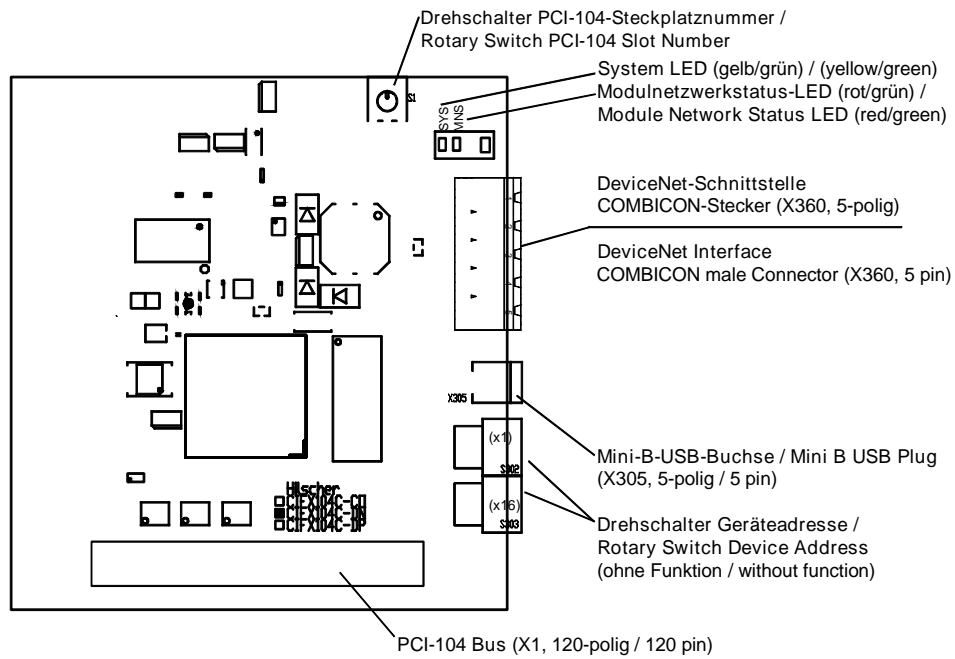

Figure 29: CIFX 104C-DN

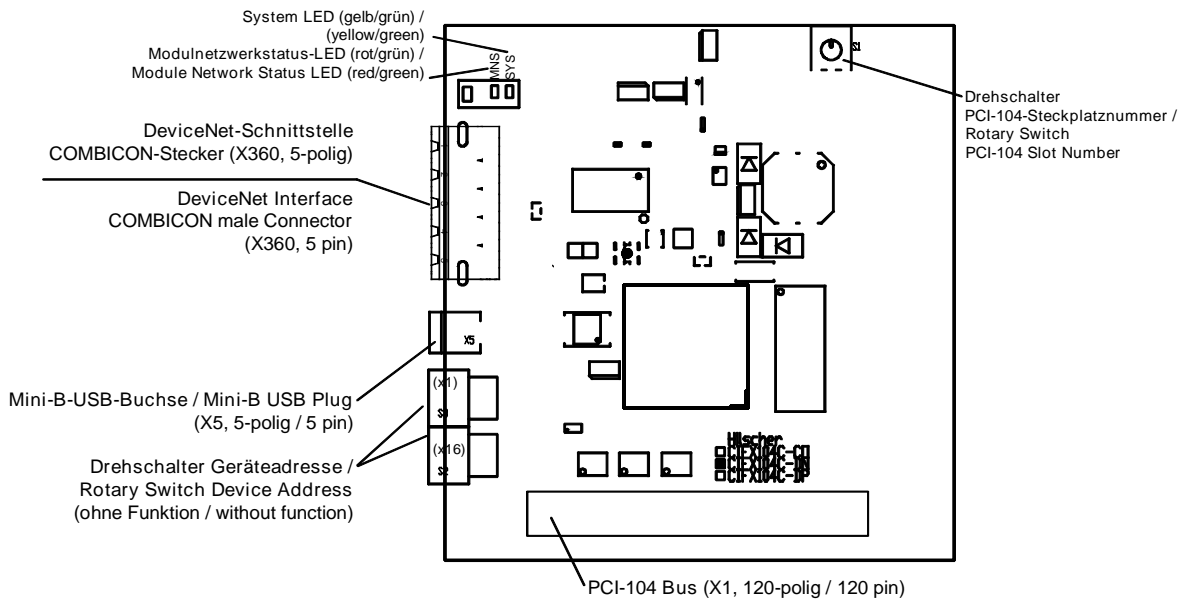

Figure 30: CIFX 104C-DN-R



For further information on the **Mini-B USB Connector** refer to section *Mini-B USB Connector (5 Pin)* on page 143.

3.3.6 CIFX 104C-DP\F, CIFX 104C-CO\F, CIFX 104C-DN\F, CIFX 104C-CC\F

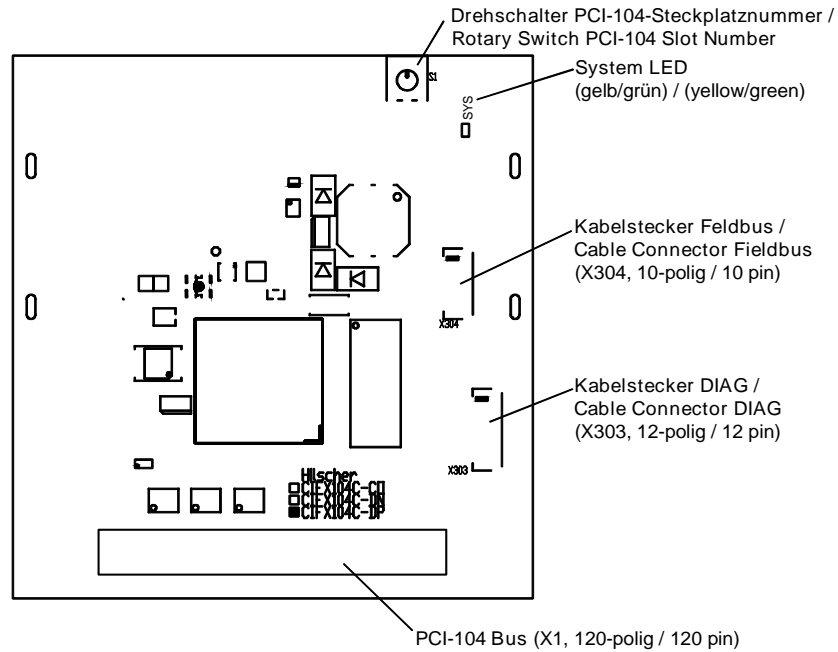

Figure 31: Basic Card CIFX 104C-FB\F for CIFX 104C-DP\F, CIFX 104C-CO\F, CIFX 104C-DN\F, CIFX 104C-CC\F

3.3.7 CIFX 104C-DP-R\F, CIFX 104C-CO-R\F, CIFX 104C-DN-R\F

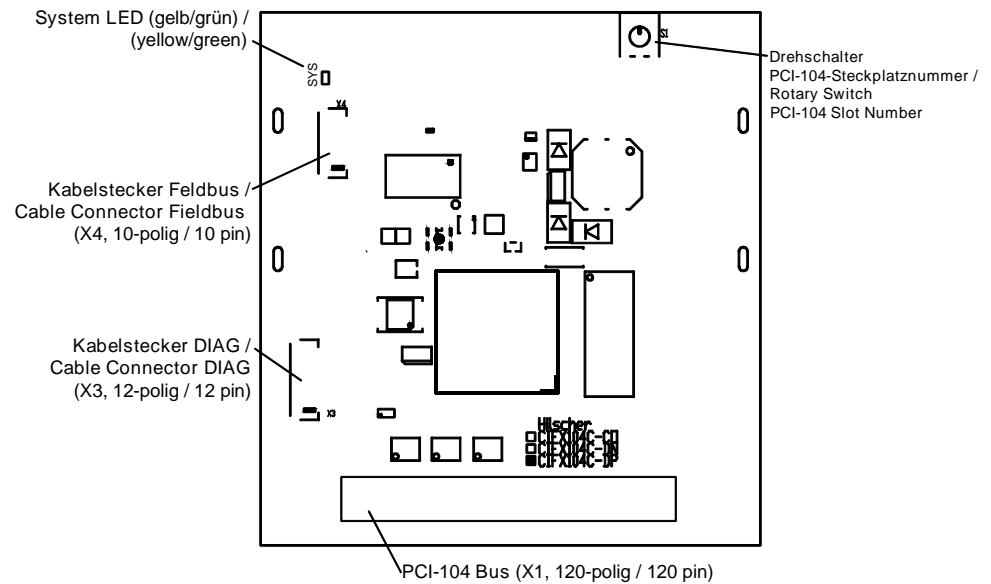

Figure 32: Basic Card CIFX 104C-FB-R\F for CIFX 104C-DP-R\F, CIFX 104C-CO-R\F, CIFX 104C-DN-R\F

3.3.8 Reverse Side CIFX 104C-XX (all Basic Cards and Variants)

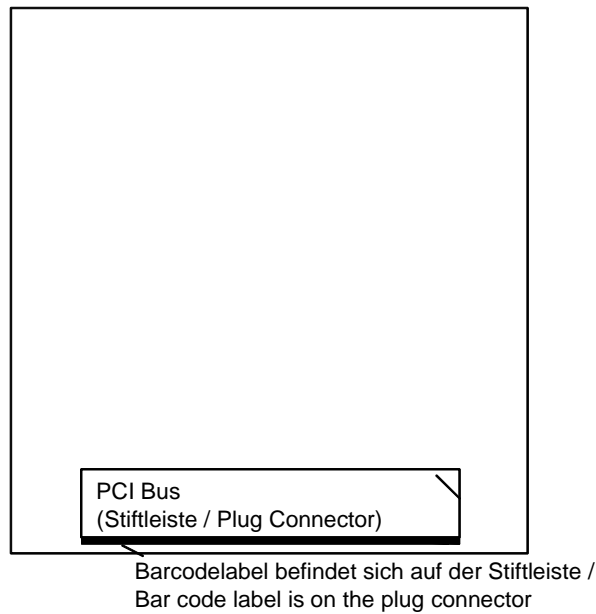

Figure 33: Reverse Side CIFX 104C-XX (all Basic Cards and Variants)

3.4 Detached Network Interfaces AIFX

3.4.1 Ethernet - AIFX-RE

Only for CIFX 90-RE\F,
 CIFX 90E-RE\F, CIFX 90E-RE\NHS\F,
 CIFX 90E-RE\ET\F,
 CIFX 90E-RE\MR\F, CIFX 90E-RE\MR\ET\F,
 CIFX 104C-RE\F, CIFX 104C-RE-R\F.

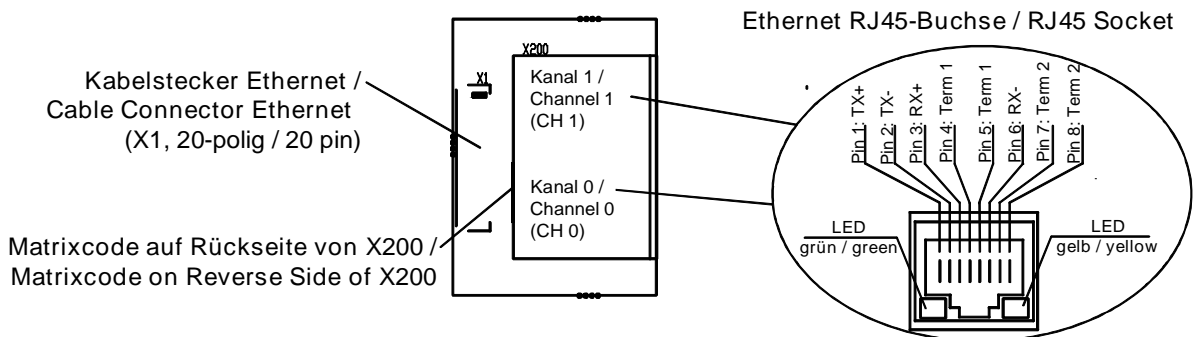
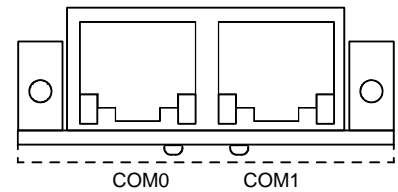
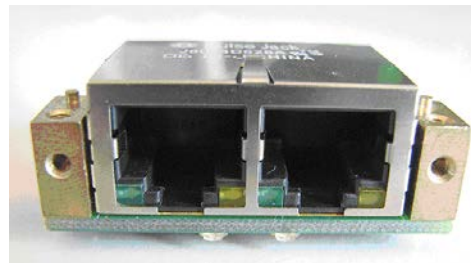

Figure 34: Detached Network Interface Ethernet (AIFX-RE)*



Note: *Assembled device supports Auto Crossover Function.



COM0: Kommunikationsstatus-LED 0 (rot/grün) / Communication Status LED 0 (red/green)
 COM1: Kommunikationsstatus-LED 1 (rot/grün) / Communication Status LED 1 (red/green)

Figure 35: Front Side and LED Display Detached Network Interface Ethernet (AIFX-RE)



The meaning of the **LEDs COM0** and **COM1** at the reverse side of the AIFX-RE and the meaning of the green and yellow LEDs at RJ45Ch0 and RJ45Ch1 corresponds to the description in chapter *Diagnosis with LEDs* beginning from page 104.

3.4.2 Ethernet - AIFX-RE\M12

Only for CIFX 90-RE\F\M12,
 CIFX 90E-RE\F\M12, CIFX 90E-RE\NHS\F\M12,
 CIFX 90E-RE\ET\F\M12,
 CIFX 90E-RE\MR\F\M12, CIFX 90E-RE\MR\ET\F\M12,
 CIFX 104C-RE\F\M12, CIFX 104C-RE-R\F\M12.

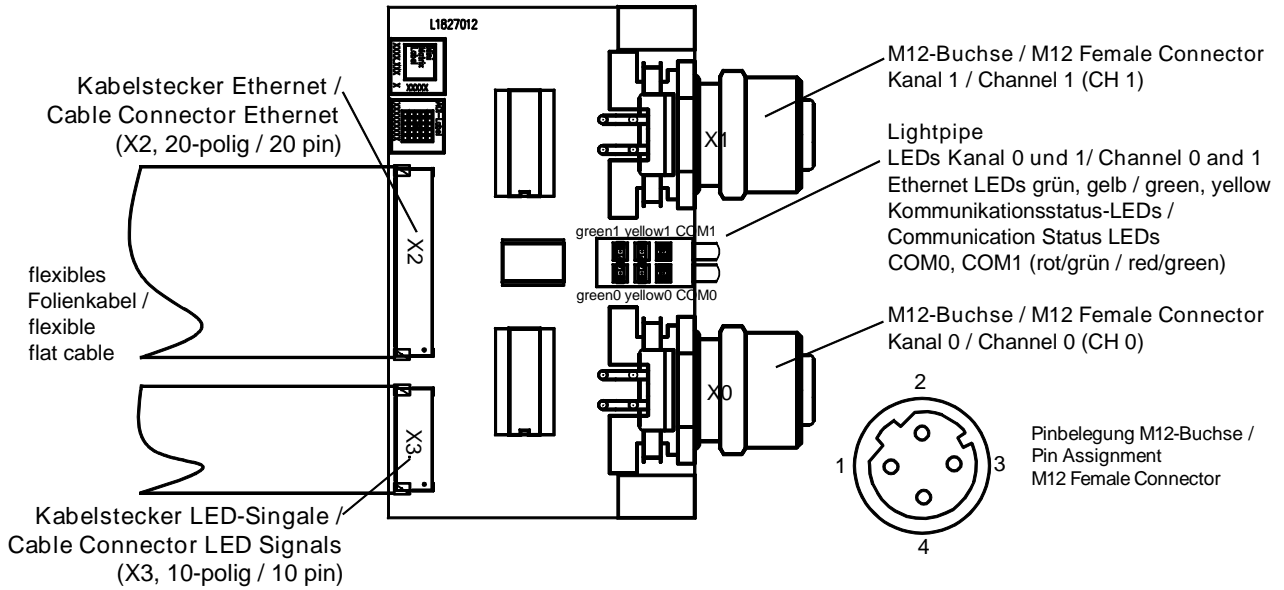

Figure 36: Ethernet M12 detached Network Interface (AIFX-RE\M12)



Note: *Assembled device supports Auto Crossover Function.

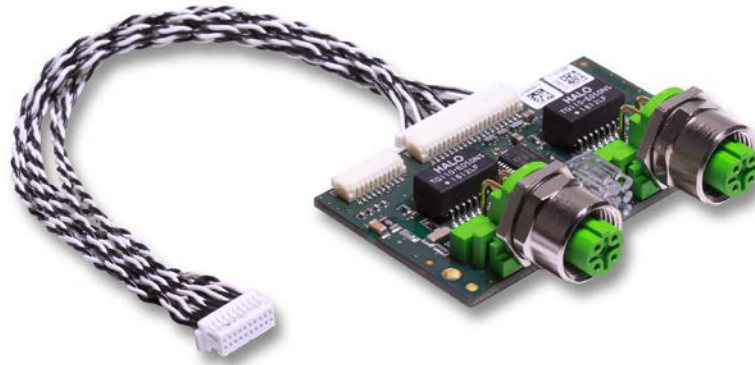

Figure 37: Ethernet M12 detached Network Interface (AIFX-RE\M12)



The meaning of the **LEDs COM0** and **COM1** and of the green and yellow Ethernet LEDs (for channel0 and channel1) of the AIFX-RE\M12 corresponds to the description in chapter *Diagnosis with LEDs* beginning from page 104.

3.4.3 PROFIBUS - AIFX-DP

Only for CIFX 90-DP\F,
 CIFX 90E-DP\F, CIFX 90E-DP\NHS\F,
 CIFX 90E-DP\ET\F,
 CIFX 90E-DP\MR\F, CIFX 90E-DP\MR\ET\F,
 CIFX 104C-DP\F, CIFX 104C-DP\R\F.

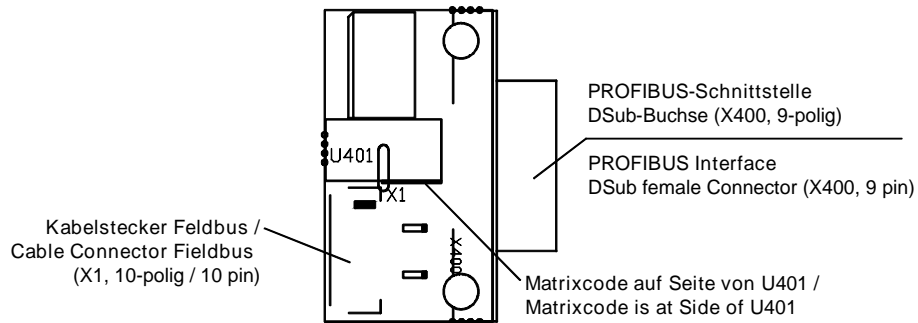

Figure 38: PROFIBUS detached Network Interface (AIFX-DP)

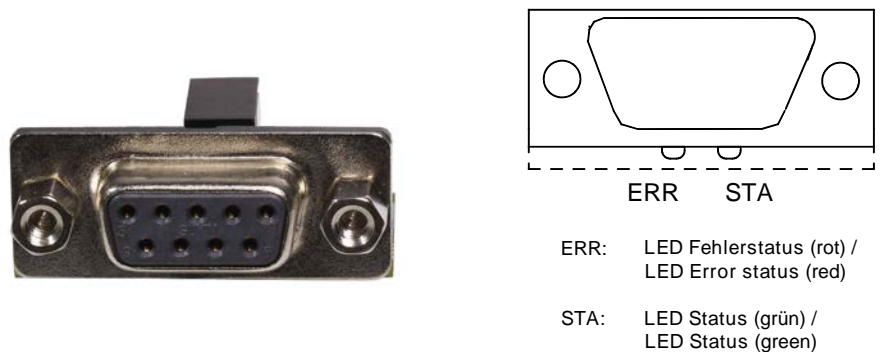

Figure 39: Front Side and LED Display PROFIBUS detached Network Interface (AIFX-DP)



The meaning of the **LEDs ERR** and **STA** at the reverse side of the AIFX-DP corresponds to the description in chapter *Diagnosis with LEDs* beginning from page 104.

3.4.4 CANopen - AIFX-CO

Only for CIFX 90-CO\F,
 CIFX 90E-CO\F, CIFX 90E-CO\NHS\F,
 CIFX 90E-CO\ET\F,
 CIFX 90E-CO\MR\F, CIFX 90E-CO\MR\ET\F,
 CIFX 104C-CO\F, CIFX 104C-CO-R\F.

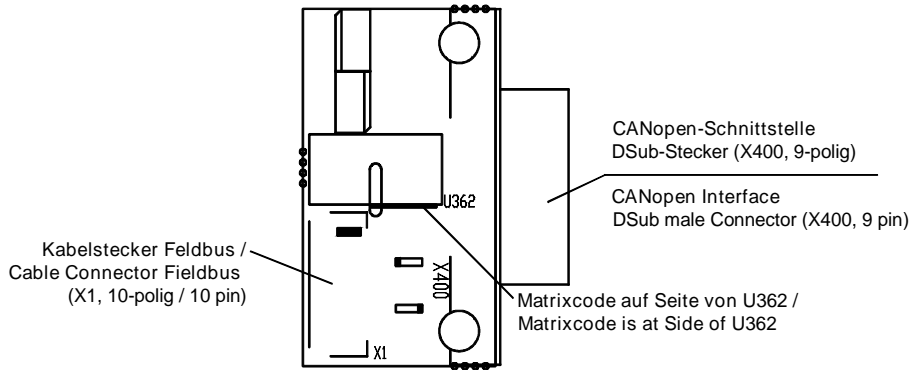

Figure 40: CANopen detached Network Interface (AIFX-CO)

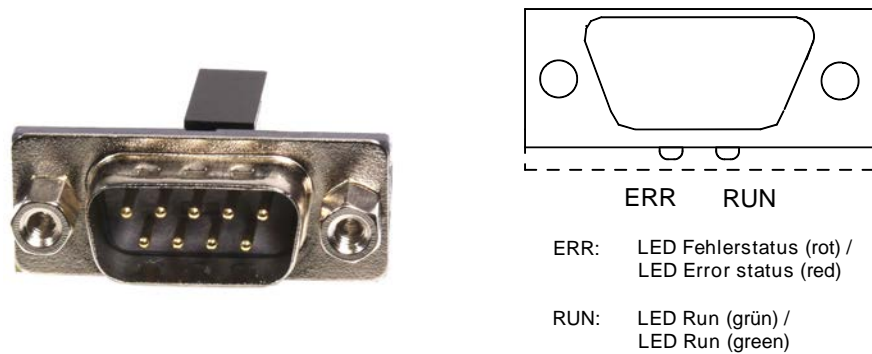

Figure 41: Front Side and LED Display detached Network Interface (AIFX-CO)



The meaning of the **LEDs ERR** and **RUN** at the reverse side of the AIFX-CO corresponds to the description in chapter *Diagnosis with LEDs* beginning from page 104.

3.4.5 DeviceNet - AIFX-DN

Only for CIFX 90-DN\F,
 CIFX 90E-DN\F, CIFX 90E-DN\NHS\F,
 CIFX 90E-DN\ET\F,
 CIFX 90E-DN\MR\F, CIFX 90E-DN\MR\ET\F,
 CIFX 104C-DN\F, CIFX 104C-DN-R\F.

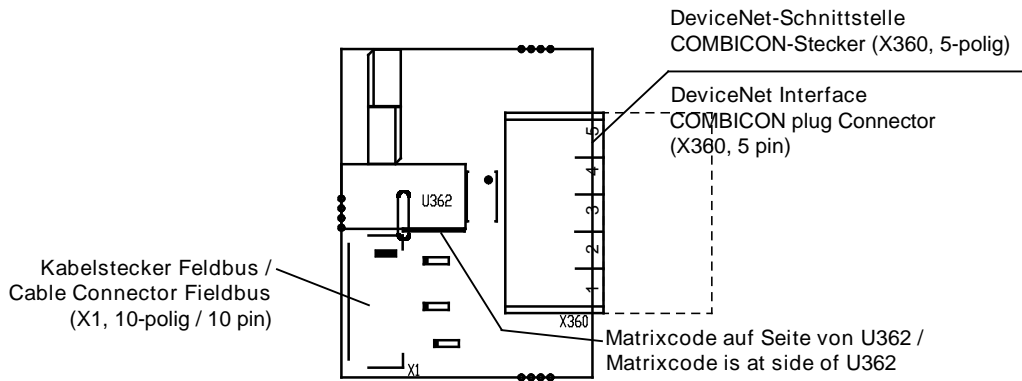

Figure 42: DeviceNet detached Network Interface (AIFX-DN, with counter part)

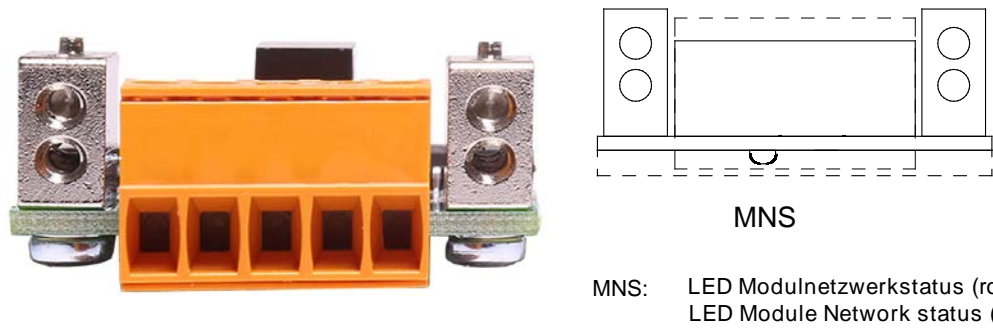

Figure 43: Front Side and LED Display DeviceNet detached Network Interface (AIFX-DN, with counter part)



The meaning of the **LED MNS** at the reverse side of the AIFX-DN corresponds to the description in chapter *Diagnosis with LEDs* beginning from page 104.

3.4.6 CC-Link - AIFX-CC

Only for CIFX 90-CC\F,
 CIFX 90E-CC\NHS\F,
 CIFX 90E-CC\ET\F,
 CIFX 90E-CC\MR\ET\F and
 CIFX 104C-CC\F.

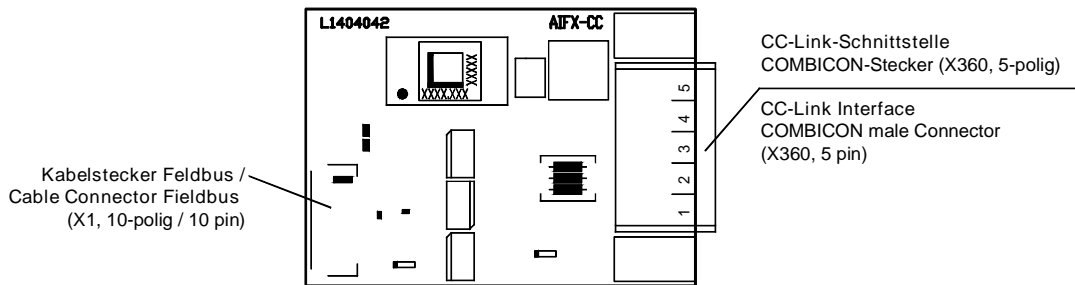

Figure 44: CC-Link detached Network Interface (AIFX-CC)

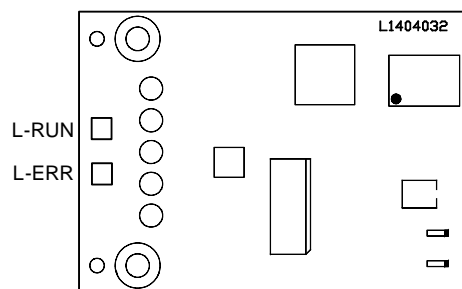

Figure 45: Reverse Side CC-Link detached Network Interface (AIFX-CC) with Matrix Label

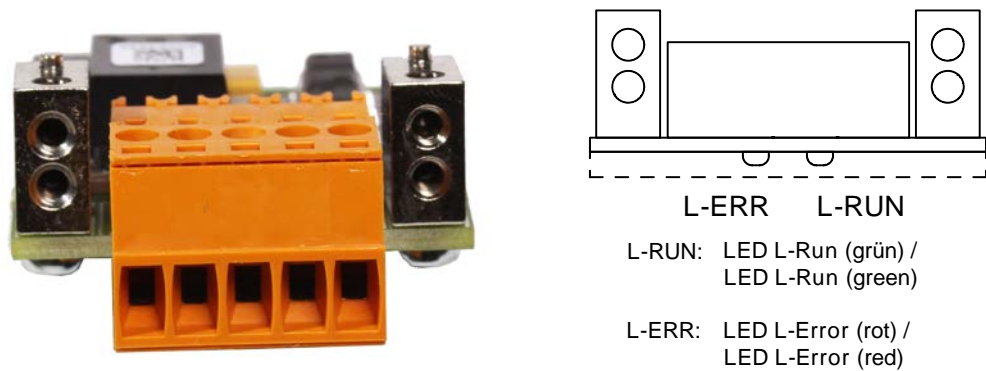

Figure 46: Front Side and LED Display CC-Link detached Network Interface (AIFX-CC, with counter part)



The meaning of the **LEDs L-RUN** and **L-ERR** at the reverse side of the AIFX-CC corresponds to the description in chapter *Diagnosis with LEDs* beginning from page 104.

3.4.7 Diagnostic - AIFX-DIAG

Only for CIFX 104C-RE\F, CIFX 104C-RE-R\F, CIFX 104C-DP\F, CIFX 104C-DP-R\F, CIFX 104C-CO\F, CIFX 104C-CO-R\F, CIFX 104C-DN\F, CIFX 104C-DN-R\F and CIFX 104C-CC\F.

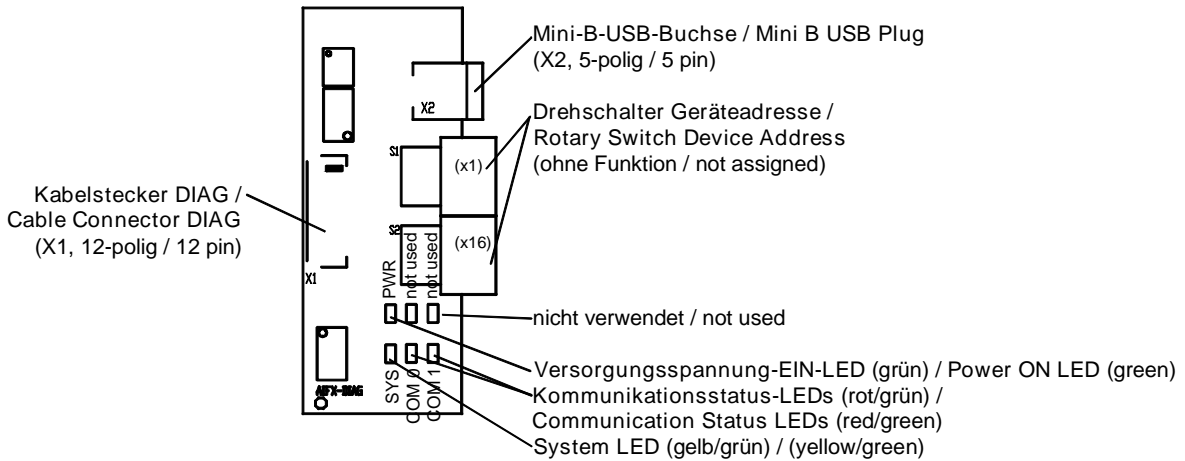
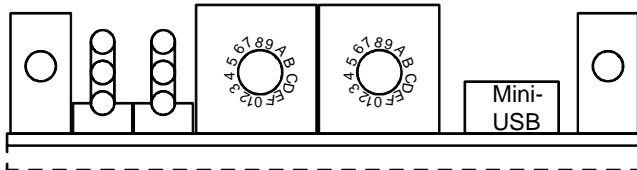
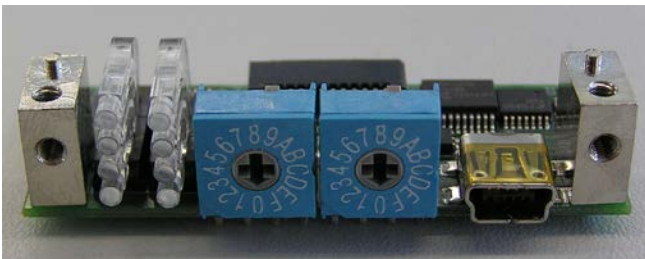

Figure 47: Diagnostic detached Network Interface (AIFX-DIAG)



The meaning of the **LEDs** at the **AIFX-DAIG** corresponds to the descriptions in chapter *Diagnosis with LEDs* beginning from page 104. For further information on the **Mini-B USB** Connector refer to section *Mini-B USB Connector (5 Pin)* on page 143.



- | | | | | | |
|------|--|-----|--|-------|--|
| SYS | | PWR | | SYS: | System LED (gelb/grün) / (yellow/green) |
| COM0 | | - | | PWR: | Versorgungsspannung-EIN-LED (grün) / Power ON LED (green) |
| COM1 | | - | | COM0: | Kommunikationsstatus-LED 0 (rot/grün) / Communication Status LED 0 (red/green) |
| | | | | COM1: | Kommunikationsstatus-LED 1 (rot/grün) / Communication Status LED 1 (red/green) |

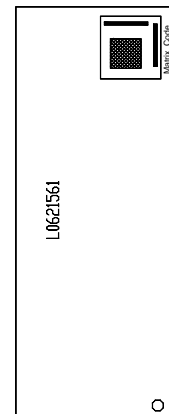

Reverse Side with Matrix Label

Figure 48: Front Side, LED Display and Reverse Side Diagnostic detached Network Interface (AIFX-DIAG)

4 Safety

4.1 General Note

The documentation in the form of a user manual, an operating instruction manual or other manual types, as well as the accompanying texts have been created for the use of the products by educated personnel. When using the products, all Safety Messages, Integrated Safety Messages, Property Damage Messages and all valid legal regulations must be obeyed. Technical knowledge is presumed. The user has to assure that all legal regulations are obeyed.

4.2 Intended Use

The **PC cards cifX** described in this user manual are PC cards for the Real-Time Ethernet or fieldbus communication. Depending from the loaded firmware, the Real-Time Ethernet or fieldbus systems listed in the following table can be realized using the respective PC card cifX.

PC Cards cifX	Real-Time Ethernet System	PC Cards cifX	Fieldbus System		
CIFX 80-RE CIFX 90-RE\F CIFX 90-RE\F\M12 CIFX 90E-RE\F CIFX 90E-RE\F\M12 CIFX 90E-RE\NHS\F CIFX 90E-RE\NHS\F\M12 CIFX 90E-RE\ET\F CIFX 90E-RE\ET\F\M12 CIFX 90E-RE\MR\F CIFX 90E-RE\MR\F\M12 CIFX 90E-RE\MR\ET\F CIFX 90E-RE\MR\ET\F\M12 CIFX 104C-RE CIFX 104C-RE-R CIFX 104C-RE\F CIFX 104C-RE-R\F CIFX 104C-RE-R\F\M12	CC-Link IE Field Basic Slave	CIFX 80-CO CIFX 90-CO\F CIFX 90E-CO\F CIFX 90E-CO\NHS\F CIFX 90E-CO\ET\F CIFX 90E-CO\MR\F CIFX 90E-CO\MR\ET\F CIFX 90E-2CO\ET\F CIFX 90E-2CO\MR\ET\F CIFX 104C-CO CIFX 104C-CO-R CIFX 104C-CO\F CIFX 104C-CO-R\F	CANopen Master, CANopen Slave		
	EtherCAT Master, EtherCAT Slave				
	EtherNet/IP Scanner (Master), EtherNet/IP Scanner (Slave)				
	Open Modbus/TCP				
	POWERLINK Controlled Node/Slave				
	PROFINET IO-Controller (Master), PROFINET IO-Device (Slave)			CIFX 90E-2CO\DN\ET\F CIFX 90E-2CO\DN\MR\ET\F	CANopen Slave DeviceNet Slave
	Sercos Master, Sercos Slave				
	VARAN Client (Slave)				
	PC Cards cifX			Fieldbus System	CIFX 80-DN CIFX 90-DN\F CIFX 90E-DN\F CIFX 90E-DN\NHS\F CIFX 90E-DN\ET\F CIFX 90E-DN\MR\F CIFX 90E-DN\MR\ET\F CIFX 90E-2DN\ET\F CIFX 90E-2DN\MR\ET\F CIFX 104C-DN CIFX 104C-DN-R CIFX 104C-DN\F CIFX 104C-DN-R\F
CIFX 80-DP CIFX 90-DP\F CIFX 90E-DP\F CIFX 90E-DP\NHS\F CIFX 90E-DP\ET\F CIFX 90E-DP\MR\F CIFX 90E-DP\MR\ET\F CIFX 104C-DP CIFX 104C-DP-R CIFX 104C-DP\F CIFX 104C-DP-R\F	PROFIBUS DP Master, PROFIBUS DP Slave, PROFIBUS MPI Device				
CIFX 90E-2DP\ET\F CIFX 90E-2DP\MR\ET\F	PROFIBUS DP Master, PROFIBUS DP Slave				
CIFX 90E-2DP\CO\ET\F CIFX 90E-2DP\CO\MR\ET\F	PROFIBUS DP Slave CANopen Slave	CIFX 90-CC\F CIFX 90E-CC\NHS\F CIFX 90E-CC\ET\F CIFX 90E-CC\MR\ET\F CIFX 104C-CC\F	CC-Link Slave		
CIFX 90E-2DP\DN\ET\F CIFX 90E-2DP\DN\MR\ET\F	PROFIBUS DP Slave DeviceNet Slave				

Table 21: PC Cards cifX and the Real-Time Ethernet or Fieldbus Systems realizable

The **Detached Network Interfaces AIFX** are each attached to the respective basic card for the PC card cifX via a cable connector (label „\F“). This way the PC card cifX is equipped with a Real-Time Ethernet or fieldbus interface and for the PC card cifX PCI-104 in addition with a diagnostic interface.

AIFX	PC Cards cifX with AIFX detached Network Interface
AIFX-RE	CIFX 90-RE\F, CIFX 90E-RE\F, CIFX 90E-RE\NHS\F, CIFX 90E-RE\ET\F, CIFX 90E-RE\MR\F, CIFX 90E-RE\MR\ET\F, CIFX 104C-RE\F, CIFX 104C-RE-R\F
AIFX-RE\M12	CIFX 90-RE\F\M12, CIFX 90E-RE\F\M12, CIFX 90E-RE\NHS\F\M12, CIFX 90E-RE\ET\F\M12, CIFX 90E-RE\MR\F\M12, CIFX 90E-RE\MR\ET\F\M12, CIFX 104C-RE\F\M12, CIFX 104C-RE-R\F\M12
AIFX-DP	CIFX 90-DP\F, CIFX 90E-DP\F, CIFX 90E-DP\NHS\F, CIFX 90E-DP\ET\F, CIFX 90E-DP\MR\F, CIFX 90E-DP\MR\ET\F, CIFX 90E-2DP\ET\F, CIFX 90E-2DP\MR\ET\F, CIFX 104C-DP\F, CIFX 104C-DP-R\F
AIFX-DP, AIFX-CO	CIFX 90E-2DP\CO\ET\F, CIFX 90E-2DP\CO\MR\ET\F
AIFX-DP, AIFX-DN	CIFX 90E-2DP\DN\ET\F, CIFX 90E-2DP\DN\MR\ET\F
AIFX-CO	CIFX 90-CO\F, CIFX 90E-CO\F, CIFX 90E-CO\NHS\F, CIFX 90E-CO\ET\F, CIFX 90Ecccc-CO\MR\F, CIFX 90E-CO\MR\ET\F, CIFX 90E-2CO\ET\F, CIFX 90E-2CO\MR\ET\F, CIFX 104C-CO\F, CIFX 104C-CO-R\F
AIFX-CO, AIFX-DN	CIFX 90E-2CO\DN\ET\F CIFX 90E-2CO\DN\MR\ET\Fsdf
AIFX-DN	CIFX 90-DN\F, CIFX 90E-DN\F, CIFX 90E-DN\NHS\F, CIFX 90E-DN\ET\F, CIFX 90E-DN\MR\F, CIFX 90E-DN\MR\ET\F, CIFX 90E-2DN\ET\F, CIFX 90E-2DN\MR\ET\F, CIFX 104C-DN\F, CIFX 104C-ssDN-R\F
AIFX-CC	CIFX 90-CC\F, CIFX 90E-CC\NHS\F, CIFX 90E-CC\ET\F, CIFX 90E-CC\MR\ET\F, CIFX 104C-CC\F
AIFX-DIAG (optional)	CIFX 104C-RE\F, CIFX 104C-RE-Rssss\F, CIFX 104C-RE\F\M12, CIFX 104C-RE-R\F\M12 CIFX 104C-DP\F, CIFX 104C-DP-R\F, CIFX 104C-CO\F, CIFX 104C-CO-R\F, CIFX 104C-DN\F, CIFX 104C-DN-R\F, CIFX 104C-CC\F

Table 22: PC Cards cifX with AIFX detached Network Interface

4.3 Personnel Qualification

The PC Card cifX must only be installed, configured and removed by qualified personnel. Job-specific technical skills for people professionally working with electricity must be present concerning the following topics:

- Safety and health at work
- Mounting and connecting of electrical equipment
- Measurement and Analysis of electrical functions and systems
- Evaluation of the safety of electrical systems and equipment
- Installing and Configuring IT systems.

4.4 Safety Instructions

To ensure your own personal safety and to avoid personal injury, you necessarily must read, understand, and comply with the safety instructions and safety messages in this manual before you install and operate your PC card cifX.

For cases if both, personal injury as well as property damage (damage of equipment or device) may occur together, you find the safety instructions in this section.

4.4.1 Hazardous Voltage, electric Shock

Danger to life or risk of injury by electric shock may occur if you open the housing of your PC (or connection device) to install your PC card.

- **Hazardous voltages** are present in the PC (or connection device) for mounting. Strictly obey to all safety rules provided by the PC's manufacturer in the documentation!
- First disconnect the power plug of the PC (or connection device), before you open the housing.
- Make sure that the power supply is off at the PC (or connection device).
- Only then open the housing and install or remove the PC card.

Reference Safety [S2]

4.4.2 Communication Stop during Firmware Update or Configuration Download

If you want to perform either a firmware update (as a download) or a configuration download, both via the corresponding Master DTM in SYCON.net, be aware of the following:

- Together with the firmware download, an automated reset to the device is performed that will interrupt all network communication and all established connections will drop.
- If you download the configuration during bus operation, the communication between master and slaves is stopped.

Possible faulty System Operation

- An unpredictable and unexpected behavior of machines and plant components may cause personal injury and property damage.
 - Stop the application program, before starting the firmware update or before downloading the configuration.
 - Make sure that your equipment operates under conditions that prevent personal injury or property damage. All network devices should be placed in a fail-safe mode, before starting the firmware update or before downloading a configuration.

Loss of Device Parameters, Overwriting of Firmware

- Both the firmware download and the configuration download erase the configuration data base. The firmware download overwrites the existing firmware in the network device.
 - To complete the firmware update and to make the device operable again, re-load the configuration after the firmware update has been finished.

For devices with Ethernet technology

- Device parameters that have been saved volatile, e. g. as the temporarily set IP address parameters, are getting lost during the reset.
 - In order to prevent loss of configuration data, make sure that your project configuration data are saved non-volatile, before you initiate a firmware update or download the configuration.

4.4.3 Mismatching System Configuration

Mismatching system configuration loaded into the device could result in faulty data mapping in the application program and thus unexpected equipment operation may cause personal injury or damage of equipment.

- In the device use only a configuration suitable for the system.

4.5 Property Damage

To avoid system damage and device damage to the PC card cifX, you necessarily must read, understand, and comply with the safety instructions and safety messages in this manual before you install and operate the PC card cifX.

4.5.1 Exceeding permissible Supply Voltage

To avoid device damage due to high supply voltage to your PC card cifX, you must observe the following instructions. These instructions apply to all PC cards cifX described in this manual.

The PC card cifX may only be operated with the specified supply voltage. Make sure that the limits of the permissible range for the supply voltage are not exceeded. A supply voltage above the upper limit can cause severe damage to the PC card cifX! A supply voltage below the lower limit can cause malfunction in the PC card cifX. The permissible range for the supply voltage is defined by the tolerances specified in this manual.

For the PC cards listed hereafter adhere specifically: The PC card cifX

- CIFX 80-RE, CIFX 80-DP, CIFX 80-CO, CIFX 80-DN,
- CIFX 90-RE\F, CIFX 90-RE\FM12,
- CIFX 90-DP\F, CIFX 90-CO\F, CIFX 90-DN\F, CIFX 90-CC\F,
- CIFX 90E-RE\F, CIFX 90E-RE\NHS\F, CIFX 90E-RE\ET\F,
- CIFX 90E-RE\FM12, CIFX 90E-RE\NHS\FM12, CIFX 90E-RE\ET\FM12,
- CIFX 90E-DP\F, CIFX 90E-DP\NHS\F, CIFX 90E-DP\ET\F,
- CIFX 90E-CO\F, CIFX 90E-CO\NHS\F, CIFX 90E-CO\ET\F,
- CIFX 90E-DN\F, CIFX 90E-DN\NHS\F, CIFX 90E-DN\ET\F,
- CIFX 90E-CC\NHS\F, CIFX 90E-CC\ET\F,
- CIFX 90E-RE\MR\F, CIFX 90E-RE\MR\ET\F,
- CIFX 90E-RE\MR\FM12, CIFX 90E-RE\MR\ET\FM12,
- CIFX 90E-DP\MR\F, CIFX 90E-DP\MR\ET\F,
- CIFX 90E-CO\MR\F, CIFX 90E-CO\MR\ET\F,
- CIFX 90E-DN\MR\F, CIFX 90E-DN\MR\ET\F,
- CIFX 90E-CC\MR\ET\F,
- CIFX 90E-2DP\ET\F, CIFX 90E-2DP\MR\ET\F,
- CIFX 90E-2DP\CO\ET\F, CIFX 90E-2DP\CO\MR\ET\F,
- CIFX 90E-2DP\DN\ET\F, CIFX 90E-2DP\DN\MR\ET\F,
- CIFX 90E-2CO\ET\F, CIFX 90E-2CO\MR\ET\F,
- CIFX 90E-2CO\DN\ET\F, CIFX 90E-2CO\DN\MR\ET\F,
- CIFX 90E-2DN\ET\F, CIFX 90E-2DN\MR\ET\F

may not be powered by a 5V supply voltage! The PC card cifX may only be powered by a 3.3 V dc $\pm 5\%$ supply voltage.



The data on the mandatory supply voltage for the PC cards cifX described in this manual you find in section *Power Supply and Host Interface* on page 67. There the required and permitted supply voltage is provided by device type inclusively the permitted tolerance range.

4.5.2 Exceeding permissible Signaling Voltage

To avoid device damage due to high signal voltage to your PC card cifX, you must observe the following instructions. These instructions apply to all PC cards cifX described in this manual.

- All I/O signal pins at the PC card cifX tolerate only a specified signaling voltage!
- Operation with a signaling voltage other than the specified signaling voltage may lead to severe damage to the PC card cifX!



The data on the mandatory signaling voltage for the PC cards cifX described in this manual you find in the section *Power Supply and Host Interface* on page 67. There the required and permitted signaling voltage is provided by device type.

4.5.3 Electrostatic sensitive Devices

This equipment is sensitive to electrostatic discharge, which cause internal damage and affect normal operation. Therefore adhere to the necessary safety precautions for components that are vulnerable with electrostatic discharge if you install or replace your device. Follow the guidelines listed hereafter when you handle this equipment:

- Touch a grounded object to discharge potential static.
- Wear an approved grounding wriststrap.
- Do not touch connectors or pins on the PC Card cifX.
- Do not touch circuit components inside the equipment.
- If available, use a static-safe workstation.
- When not in use, store the equipment in appropriate static-safe packaging.

Reference Safety [S3]

4.5.4 Power Disconnect while downloading Firmware or Configuration

If during the process of downloading a firmware or configuration

- the power supply to a PC with the software application is interrupted,
- or the power supply to the PC card cifX is interrupted,
- or a reset to the PC card cifX is performed,

this may lead to the following consequences:

Loss of Device Parameters, Firmware Corruption

- The firmware download or the configuration download will be interrupted and remains incomplete.
- The firmware or the configuration database will be corrupted and device parameters will be lost.
- Device damage may occur as the PC card cifX cannot be rebooted.

Whether these consequences occur depends on when the power disconnect occurs during the download.

- During configuration download process, do not interrupt the power supply to the PC, or to the PC card cifX and do not perform a reset!

Otherwise you might be forced to return your PC card cifX for repair.

Power Drop during Write and Delete Accesses in the File System

The FAT file system in the netX firmware is subject to certain limitations in its operation. Write and delete accesses in the file system (firmware update, configuration download etc.) can destroy the FAT (File Allocation Table) if the accesses cannot be completed if the power drops. Without a proper FAT, a firmware may not be found and cannot be started.

Make sure that the power supply to the device is not interrupted during write and delete accesses in the file system (firmware update, configuration download, etc.).

4.5.5 Exceeding the maximum Number of allowed Write/Delete Accesses

This device uses a serial Flash chip for storing remanent data, such as firmware, configuration, etc. This chip allows a maximum of 100 000 write/delete accesses which is sufficient for a standard device operation. Writing/deleting the chip excessively (e.g. in order to change configuration or name of station) will exceed the maximum number of allowed write/delete accesses and, thus, result in damage to the device. If, e.g., the configuration is changed every hour, the maximum number will be reached after 11.5 years. If, e.g., it is changed every minute, the maximum number will already be reached after approx. 69 days.

Avoid exceeding the maximum number of allowed write/delete accesses by excessive writing.

4.5.6 Invalid Firmware

Loading invalid firmware files could render your device unusable.

- Only download firmware files to your PC Card cifX that are valid for this device.

Otherwise you may be forced to return your device for repair.

4.5.7 Information and Data Security

Take all usual measures for information and data security, in particular for PC Cards cifX with Ethernet technology. Hilscher explicitly points out that a device with access to a public network (Internet) must be installed behind a firewall or only be accessible via a secure connection such as an encrypted VPN connection. Otherwise the integrity of the device, its data, the application or system section is not safeguarded.

Hilscher can assume no warranty and no liability for damages due to neglected security measures or incorrect installation.

5 Requirements

5.1 System Requirements

5.1.1 Slot for the PC Cards cifX Compact PCI, Mini PCI, Mini PCIe, PCI-104

PC with slot (3.3 V) for PC cards cifX *Compact PCI, Mini PCI, Mini PCI Express and PCI-104*:

PC Cards cifX	PCI Bus [Pins]	Slot	
CIFX 80-RE CIFX 80-DP CIFX 80-CO CIFX 80-DN	110	Compact PCI Slot (3.3 V)	
CIFX 90-RE\F CIFX 90-RE\F\M12 CIFX 90-DP\F CIFX 90-CO\F CIFX 90-DN\F CIFX 90-CC\F	124	Mini PCI Socket (3.3 V), Type III System Connector	
CIFX 90E-RE\F CIFX 90E-RE\F\M12 CIFX 90E-DP\F CIFX 90E-CO\F CIFX 90E-DN\F CIFX 90E-RE\NHS\F CIFX 90E-RE\NHS\F\M12 CIFX 90E-DP\NHS\F CIFX 90E-CO\NHS\F CIFX 90E-DN\NHS\F CIFX 90E-CC\NHS\F CIFX 90E-RE\ET\F CIFX 90E-RE\ET\F\M12 CIFX 90E-DP\ET\F CIFX 90E-CO\ET\F CIFX 90E-DN\ET\F CIFX 90E-CC\ET\F CIFX 90E-RE\MR\F CIFX 90E-RE\MR\F\M12 CIFX 90E-DP\MR\F CIFX 90E-CO\MR\F CIFX 90E-DN\MR\F CIFX 90E-RE\MR\ET\F CIFX 90E-RE\MR\ET\F\M12 CIFX 90E-DP\MR\ET\F CIFX 90E-CO\MR\ET\F CIFX 90E-DN\MR\ET\F CIFX 90E-CC\MR\ET\F	52	PCI Express Mini System Connector (3.3 V), X1/X2¹ = One Lane  Note: As the basic cards CIFX 90E (all variants 'NHS', 'ET', 'MR' or with M12), CIFX 90E-2FB\ET or CIFX 90E-2FB\MR\ET can be inserted correctly into the Mini PCI Express slot, the element height in the Mini PCI Express slot of the connection device must meet to the standard specifications.	
CIFX 104C-RE CIFX 104C-RE-R CIFX 104C-RE\F CIFX 104C-RE\F\M12 CIFX 104C-RE-R\F CIFX 104C-RE-R\F\M12 CIFX 104C-DP CIFX 104C-DP-R CIFX 104C-DP\F CIFX 104C-DP-R\F	CIFX 104C-CO CIFX 104C-CO-R CIFX 104C-CO\F CIFX 104C-CO-R\F CIFX 104C-DN CIFX 104C-DN-R CIFX 104C-DN\F CIFX 104C-DN-R\F CIFX 104C-CC\F	120	PCI-104 Slot (Supply Voltage 5 V or 3.3 V, Signaling Voltage 5 V or 3.3 V)

Table 23: Slot for the PC Cards cifX *Compact PCI, Mini PCI, Mini PCIe, Mini PCIe (2 channel), PCI-104*

¹ X1, X2 corresponds to the Hilscher convention for „interface“ on the top or the bottom side of the PC Card cifX.

5.1.2 Notes on the Card Height - PC Card cifX Mini PCI and Mini PCIe

PC Cards cifX	Dimensions (L x B x D)	Note
Mini PCI		
CIFX 90-RE\F, CIFX 90-RE\F\M12, CIFX 90-DP\F, CIFX 90-CO\F, CIFX 90-DN\F bzw. CIFX 90-CC\F	60,0 x 45 x 9,5	The element heights <u>on top</u> of the PC cards CIFX 90-XX\F Mini PCI (all variants) do not meet the standard specifications.
Mini PCI Express		
CIFX 90E-XX\F and CIFX 90E-RE\F\M12 (from hardware revision A), CIFX 90E-XX\MR\F and CIFX 90E-RE\MR\F\M12 (from hardware revision B)	51 x (30,2 +/- 0,1) x 11	The element heights <u>on top</u> of the PC card CIFX 90E-XX\F Mini PCI Express (all variants and 2 channel formats) ² do not meet the standard specifications. Note: The element height at the bottom side of the PC card CIFX 90E-XX\F (all variants and 2 channel formats) is in accordance with the standard specifications. As the PC card CIFX 90E-XX\F (all variants and 2 channel formats) can be inserted correctly into the Mini PCI Express slot, the element height in the Mini PCI Express slot of the connection device must meet to the standard specifications.
CIFX 90E-XX\NHS\F and CIFX 90E-RE\NHS\F\M12	51 x (30,2 +/- 0,1) x 10,8	The element heights of the cable connectors ‚Ethernet (X4)‘ or ‚Fieldbus (X3)‘ are appr. 8,5 mm over PCB each, including the cable.
CIFX 90E-XX\ET\F, CIFX 90E-RE\ET\F\M12, CIFX 90E-XX\MR\ET\F\M12, CIFX 90E-2XX\ET\F, CIFX 90E-2XX\XX\ET\F, CIFX 90E-2XX\MR\ET\F, CIFX 90E-2XX\XX\MR\ET\F	51 x (30,2 +/- 0,1) x 12,5	

Table 24: Notes on the Card Height - PC Card cifX Mini PCI and Mini PCI Express

Data in milli meters (mm)	CIFX 90E-XX\F, CIFX 90E-XX\F\M12, CIFX 90E-XX\MR\F, CIFX 90E-XX\MR\F\M12	CIFX 90E-XX\NHS\F, CIFX 90E-RE\NHS\F\M12	CIFX 90E-XX\ET\F, CIFX 90E-XX\ET\F\M12, CIFX 90E-XX\MR\ET\F, CIFX 90E-XX\MR\ET\F\M12, CIFX 90E-2XX\ET\F, CIFX 90E-2XX\XX\ET\F, CIFX 90E-2XX\MR\ET\F, CIFX 90E-2XX\XX\MR\ET\F	T Tolerance
Cable connector including cable		+ 8,5		
netX 100 Cooling Element	+ 6,4	-	+ 7,8	+/- 0,2
Element height topside	+ 1,83	-	+ 1,83	+/- 0,18
Height of the printed circuit	+ 1,0	+ 1,0	+ 1,0	+/- 0,1
Element height bottom side	+ 1,3	+ 1,3	+ 1,3	+/- 0,1
Max. total height (D) of the PC card cifX	= ~ 11	= ~ 10,8	= ~ 12,5	

Table 25: Max. Total Height (D) of the PC Card cifX

² Variants of the PC card CIFX 90E-XX\F:

CIFX 90E-XX\F, CIFX 90E-XX\NHS\F, CIFX 90E-XX\ET\F, CIFX 90E-XX\MR\F, CIFX 90E-XX\MR\ET\F (XX = RE, DP, CO, DN or for the variants ‚NHS‘, ‚ET‘ or ‚MR\ET‘ also = CC);

Variants with Ethernet M12 detached Network Interface (AIFX-RE\M12):

CIFX 90E-RE\F\M12, CIFX 90E-RE\NHS\F\M12, CIFX 90E-RE\ET\F\M12, CIFX 90E-RE\MR\F\M12, CIFX 90E-RE\MR\ET\F\M12;

2 Channel format: CIFX 90E-2XX\ET\F, CIFX 90E-2XX\XX\ET\F, CIFX 90E-2XX\MR\ET\F, CIFX 90E-2XX\XX\MR\ET\F

5.1.3 Panel Cutout for Installing AIFX

In order to connect the AIFX detached network interface to a PC card cifX **Mini PCI** and **Mini PCI Express** with cable connector Ethernet or fieldbus (labeling „\F“), make sure that **the housing panel of the PC or of the connection device** has an appropriate cutout and holes for fastening the AIFX.

In order to connect the AIFX detached network interface to a PC card cifX **PCI-104** with cable connector Ethernet or fieldbus (labeling „\F“), make sure that **the front plate of the PC cabinet** has an appropriate cutout and holes for fastening the AIFX.

PC Cards cifX	Panel Cutout
Mini PCI; Mini PCI Express	at the housing panel of the PC
PCI-104	at the front plate of the PC cabinet

Table 26: Panel Cutout at the at the Housing Panel of the PC or at the front plate of the PC cabinet

The panel cutout must be dimensioned sufficiently large for the interface, display or control elements placed on the AIFX. Partial standard cutouts can be used.

PC Cards cifX	AIFX	Panel Cutout and Holes	
CIFX 90-RE\F CIFX 90E-RE\F CIFX 90E-RE\NHS\F CIFX 90E-RE\ET\F CIFX 90E-RE\MR\F CIFX 90E-RE\MR\ET\F CIFX 104C-RE\F CIFX 104C-RE-R\F	AIFX-RE	Required Cutout	for two RJ45 Sockets Important! The panel cutout layout must also cover the LEDs COM 0 and COM1 at the AIFX-RE.
		Holes	2, distance between the holes 37,3 mm
		Further Information	In the data sheet <i>MOD JACK – MJIM</i> [2], as well as in section as in section <i>Ethernet - AIFX-RE</i> on page 48 or <i>Ethernet - AIFX-RE</i> on page 259.
CIFX 90-RE\F\M12 CIFX 90E-RE\F\M12 CIFX 90E-RE\NHS\F\M12 CIFX 90E-RE\ET\F\M12 CIFX 90E-RE\MR\F\M12 CIFX 90E-RE\MR\ET\F\M12 CIFX 104C-RE\F\M12 CIFX 104C-RE-R\F\M12	AIFX-RE\M12	Required Cutout	for two M12 Sockets Important! The panel cutout layout must also cover the LEDs for channel 0 and channel 1 at the AIFX-RE\M12, including the green and yellow Ethernet LEDs as well as the communication LEDs COM 0 and COM1.
		Standard cutout	M12
		Holes	2, distance between the holes 55 mm
		Further Information	In the data sheet <i>99_3732_203_04.pdf</i> [4], as well as in section <i>Ethernet - AIFX-REM12</i> on page 49 or <i>Ethernet M12 - AIFX-REM12</i> on page 260.
CIFX 90-DP\F CIFX 90E-DP\F CIFX 90E-DP\NHS\F CIFX 90E-DP\ET\F CIFX 90E-DP\MR\F CIFX 90E-DP\MR\ET\F CIFX 90E-2DP\ET\F CIFX 90E-2DP\MR\ET\F CIFX 90E-2DP\CO\ET\F CIFX 90E-2DP\COMR\ET\F CIFX 90E-2DP\DN\ET\F CIFX 90E-2DP\DNMR\ET\F CIFX 104C-DP\F CIFX 104C-DP-R\F	AIFX-DP	Required Cutout	for Dsub female Connector, 9 pin
		Standard cutout	D-Sub-9
		Holes	2, distance between the holes 25 mm
		Further Information	in section <i>PROFIBUS - AIFX-DP</i> on page 50 or on <i>PROFIBUS - AIFX-DP</i> page 261.
CIFX 80-CO CIFX 90-CO\F CIFX 90E-CO\F CIFX 90E-CO\NHS\F CIFX 90E-CO\ET\F	AIFX-CO	Required Cutout	for D-Sub male Connector, 9 pin
		Standard cutout	D-Sub-9
		Holes	2, distance between the holes 25 mm

PC Cards cifX	AIFX	Panel Cutout and Holes	
CIFX 90E-COMR\F CIFX 90E-COMR\ET\F CIFX 90E-2CO\ET\F CIFX 90E-2COMR\ET\F CIFX 90E-2DP\CO\ET\F CIFX 90E-2DP\COMR\ET\F CIFX 90E-2CO\DN\ET\F CIFX 90E-2CO\DN\MR\ET\F CIFX 104C-CO\F CIFX 104C-CO-R\F		Further Information	in section <i>CANopen - AIFX-CO</i> on page 51 or <i>CANopen - AIFX-CO</i> on page 261.
CIFX 90-DN\F CIFX 90E-DN\F CIFX 90E-DN\NHS\F CIFX 90E-DN\ET\F CIFX 90E-DN\MR\F CIFX 90E-DN\MR\ET\F CIFX 90E-2DN\ET\F CIFX 90E-2DN\MR\ET\F CIFX 90E-2DP\DN\ET\F CIFX 90E-2DP\DN\MR\ET\F CIFX 90E-2CO\DN\ET\F CIFX 90E-2CO\DN\MR\ET\F CIFX 104C-DN\F CIFX 104C-DN-R\F	AIFX-DN	Required Cutout	for CombiCon male Connector, 5 pin
		Standard cutout	CombiCon male Connector
		Holes	2x2, distance between the holes 24,94 mm
		Further Information	in section <i>DeviceNet - AIFX-DN</i> on page 52 on page <i>DeviceNet - AIFX-DN</i> on page 262.
CIFX 90-CC\F CIFX 90E-CC\NHS\F CIFX 90E-CC\ET\F CIFX 90E-CC\MR\ET\F CIFX 104C-CC\F	AIFX-CC	Required Cutout	for CombiCon male Connector, 5 pin
		Standard cutout	CombiCon male Connector
		Holes	2x2, distance between the holes 24,96 mm
		Further Information	in section <i>CC-Link - AIFX-CC</i> on page 53 or <i>CC-Link - AIFX-CC</i> on page 263.
CIFX 104C-RE\F CIFX 104C-RE-R\F CIFX 104C-DP\F CIFX 104C-DP-R\F CIFX 104C-CO\F CIFX 104C-CO-R\F CIFX 104C-DN\F CIFX 104C-DN-R\F	AIFX-DIAG	Required Cutout	for the light channels, the rotary switches and the Mini B USB plug
		Standard cutout	-
		Holes	2, distance between the holes 47,1 mm
		Further Information	in section <i>Diagnostic - AIFX-DIAG</i> on page 54 or <i>Diagnose - AIFX-DIAG</i> on 263 page.

Table 27: Required Panel Cutout and Holes for AIFX

5.1.4 Operating Temperature Range for UL Certificate

The UL certificate for the PC cards cifX is valid for the ranges 0 °C to +55 °C or 0 °C bis +70 °C depending by the device as indicated in section *Technical Data PC Cards cifX* on page 162.

Regardless of this the PC cards cifX are designed for the operating temperatures (-20 °C to +55 °C or -20 °C to +70 °C) as specified in section *Technical Data PC Cards cifX* on page 162.

5.1.5 Power Supply and Host Interface

For the power supply and the host interface used for the PC cards cifX Compact PCI, Mini PCI, Mini PCI Express and PCI-104 you must observe the following requirements:

PC Cards cifX	Supply Voltage	Signaling Voltage Host Interface	Host Interface (PCI slot)
CIFX 80-RE CIFX 80-DP CIFX 80-CO CIFX 80-DN CIFX 90-CC\F	+3.3 V dc $\pm 5\%$ / Max. 1 A	5 V or 3.3 V	Compact PCI
CIFX 90-RE\F CIFX 90-RE\F\M12 CIFX 90-DP\F CIFX 90-CO\F CIFX 90-DN\F CIFX 90-CC\F	+3.3 V dc $\pm 5\%$ / Max 1 A <i>Note:</i> The power input of the CIFX 90-XX\F or CIFX 90-XX\F\M12 does not comply with the standard specifications.	3.3 V (5 V only if 5 V are connected via pin 28. Refer also to section <i>Pin Assignment for Mini PCI Bus, X1</i> , page 156)	Mini PCI
CIFX 90E-RE\F CIFX 90E-RE\F\M12 CIFX 90E-DP\F CIFX 90E-CO\F CIFX 90E-DN\F CIFX 90E-RE\NHS\F CIFX 90E-RE\NHS\F\M12 CIFX 90E-DP\NHS\F CIFX 90E-CO\NHS\F CIFX 90E-DN\NHS\F CIFX 90E-CC\NHS\F CIFX 90E-RE\ET\F CIFX 90E-RE\ET\F\M12 CIFX 90E-DP\ET\F CIFX 90E-CO\ET\F CIFX 90E-DN\ET\F CIFX 90E-CC\ET\F CIFX 90E-RE\MR\F CIFX 90E-RE\MR\F\M12 CIFX 90E-DP\MR\F CIFX 90E-CO\MR\F CIFX 90E-DN\MR\F	CIFX 90E-RE\MR\ET\F CIFX 90E-RE\MR\ET\F\M12 CIFX 90E-DP\MR\ET\F CIFX 90E-CO\MR\ET\F CIFX 90E-DN\MR\ET\F CIFX 90E-CC\MR\ET\F CIFX 90E-2DP\ET\F CIFX 90E-2DP\CO\ET\F CIFX 90E-2DP\DN\ET\F CIFX 90E-2CO\ET\F CIFX 90E-2CO\DN\ET\F CIFX 90E-2DN\ET\F CIFX 90E-2DP\MR\ET\F CIFX 90E-2DP\CO\MR\ET\F CIFX 90E-2DP\DN\MR\ET\F CIFX 90E-2CO\MR\ET\F CIFX 90E-2CO\DN\MR\ET\F CIFX 90E-2DN\MR\ET\F	+3.3 V dc $\pm 5\%$ / Max. 1 A <i>Important!</i> For all PC cards cifX Mini PCI Express, the increase of the supply voltage from 0V to 3.3V must last longer than 180 μ s. <i>Note:</i> The power input of the CIFX 90E-XX\F (all variants) ³ does not comply with the standard specifications.	PCIe compatible Mini PCI Express
CIFX 104C-RE CIFX 104C-RE-R CIFX 104C-RE\F CIFX 104C-RE\F\M12 CIFX 104C-RE-R\F CIFX 104C-RE-R\F\M12 CIFX 104C-DP CIFX 104C-DP-R CIFX 104C-DP\F CIFX 104C-DP-R\F	CIFX 104C-CO CIFX 104C-CO-R CIFX 104C-CO\F CIFX 104C-CO-R\F CIFX 104C-DN CIFX 104C-DN-R CIFX 104C-DN\F CIFX 104C-DN-R\F CIFX 104C-CC\F	+5 V dc $\pm 5\%$ / Max. 750 mA or +3.3 V dc $\pm 5\%$ / Max. 1 A	5 V or 3.3 V PCI-104

Table 28: Requirements Power Supply and Host Interface for PC Cards cifX Compact PCI, Mini PCI, Mini PCI Express and PCI-104

The data in the Table 28 have the following meaning:

³ Variants of the PC card CIFX 90E-XX\F: CIFX 90E-XX\NHS\F, CIFX 90E-XX\ET\F, CIFX 90E-XX\MR\F or CIFX 90E-XX\MR\ET\F (XX = RE, DP, CO, DN or for the variants 'NHS', 'ET' and 'MR\ET' also = CC); or with mit Ethernet M12 Assembly Interface (AIFX-RE\M12): CIFX 90E-RE\F\M12, CIFX 90E-RE\NHS\F\M12, CIFX 90E-RE\ET\F\M12, CIFX 90E-RE\MR\F\M12, CIFX 90E-RE\MR\ET\F\M12

Supply Voltage

The required and permissible supply voltage at the PC cards cifX *Compact PCI, Mini PCI, Mini PCI Express* and *PCI-104*.



Note: To ensure that the compatibility between different systems is guaranteed, providing a maximum of 1 A (for +3.3 VDC $\pm 5\%$) or 750 mA (for +5 VDC $\pm 5\%$) is recommended.

The typical current consumption depends on the type of the PC card cifX. For detailed values on the typical current consumption see section *Technical Data PC Cards cifX* on page 162.

Signaling Voltage Host Interface

- at the Compact PCI bus of the PC cards cifX *Compact PCI*,
- at the Mini PCI bus of the PC cards cifX *Mini PCI*,
- at the Mini PCI Express bus of the PC cards cifX *Mini PCI Express*
- as well as at the PCI-104 bus of the PC cards cifX *PCI-104*.

Host Interface (PCI slot) Type of the host interface

Requirements for the power supply for all PC cards cifX Mini PCI Express



Important! For all PC cards cifX Mini PCI Express, the increase of the supply voltage from 0V to 3.3V must last longer than 180 μ s.

The power supply unit (host or PC) must comply with this requirement, in order to avoid exceeding the maximum permissible inrush current specified in the bus specifications for Mini PCI Express [bus spec 6, revisions 2.0 and 1.2]. The following figure shows the temporal behavior for the increase of the supply voltage to be complied with:

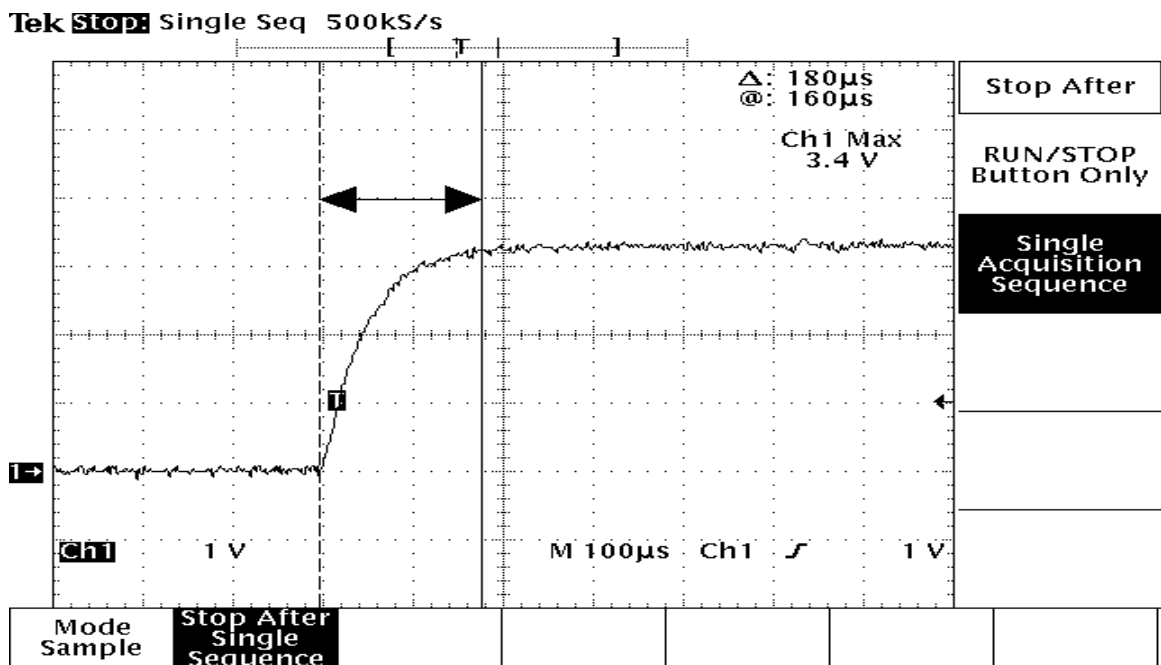

Figure 49: Requirement for the temporal Behavior of the Supply Voltage for PC cards cifX Mini PCI Express



For the reference for the bus specification for Mini PCI Express [bus spec 6] refer to section *References PCI Specifications* on page 264 of this manual.

5.1.6 Warnings on Supply and Signaling Voltage

When commissioning the PC card cifX, please observe the following listed warning notes for the supply and signal voltage.



NOTICE

Exceeding permissible Supply Voltage

Operating the PC card cifX with a supply voltage above of the specified range leads to device damage.

- Use only the permissible supply voltage to operate the PC card cifX.



NOTICE

Exceeding permissible Signaling Voltage

All I/O signal pins at the PC card cifX tolerate only the specified signaling voltage! Operating the PC card cifX with a signaling voltage other than the specified signaling voltage may lead to severe damage to the PC card cifX!

- For the operation of the PC card cifX use only the specified signaling voltage.

5.1.7 Warnings on Supply and Signaling Voltage (USA)

When commissioning the PC card cifX, please observe the following listed warning notes for the supply and signal voltage.

NOTICE

Exceeding permissible Supply Voltage

Operating the PC card cifX with a supply voltage above of the specified range leads to device damage.

- Use only the permissible supply voltage to operate the PC card cifX.

NOTICE

Exceeding permissible Signaling Voltage

All I/O signal pins at the PC card cifX tolerate only the specified signaling voltage! Operating the PC card cifX with a signaling voltage other than the specified signaling voltage may lead to severe damage to the PC card cifX!

- For the operation of the PC card cifX use only the specified signaling voltage.

5.1.8 AIFX-RE\M12: Max. permissible Current per external LED

When using the Ethernet AIFX-RE\M12 detached network interface with the requirement IP67 and the LED signals are routed via the cable connector LED signals X3 to the mainboard or to a separate detached LED board, the maximum current drawn per LED must not exceed 5 mA.



Note: The outputs on the cable connector LED signals X3 can drive max. 5 mA. This means that the maximum permissible current per external LED is 5 mA. If this maximum current is not sufficient, an external driver is required previous to the LED.

5.2 Requirements for Operation of the PC Cards cifX

Operating the PC cards cifX properly, the following described requirements must be fulfilled.

Protocols	CC-Link IE Field Basic Slave, EtherCAT Slave, EtherCAT Master, EtherNet/IP Adapter (Slave), EtherNet/IP Scanner (Master), Open Modbus/TCP, POWERLINK-Controlled-Node/Slave, PROFINET IO Device (Slave), PROFINET IO Controller (Master),	Sercos Slave, Sercos Master, VARAN Client (Slave)	PROFIBUS DP Slave, PROFIBUS DP Master, PROFIBUS MPI Device, CANopen Slave, CANopen Master, DeviceNet Slave, DeviceNet Master, CC-Link Slave
Software Installation	<p>1. Driver for the Host Interface Host Interfaces: Compact PCI, Mini PCI, Mini PCI Express and PCI-104</p> <ul style="list-style-type: none"> The device driver cifX Device Driver must be installed (from V1.0.x.x). <p>If you install the device into a PC, in general Windows® will be available as operating system. In this case the cifX Device Driver must be installed to communicate to the device and to exchange data via the dual-port memory.</p> <p>Important! Upgrade older versions of the cifX Device Driver necessarily on the current version indicated in section <i>Driver and Software</i> on page 32.</p> <p>OR</p> <ul style="list-style-type: none"> If Windows® is not available as operating system, an own driver must be developed using the cifX Driver Toolkit and this driver must be installed. For the operating systems Linux, Windows® CE, VxWorks, QNX and IntervalZero RTX™ you can buy Device Driver at the company Hilscher Gesellschaft für Systemautomation mbH http://www.hilscher.com/. <p>2. The configuration software SYCON.net or alternatively the simple Slave configuration tool netX Configuration Tool must be installed or another application program by which the PC card cifX (Slave) can be parameterized.</p>		
How to use the Software	<p>On how to use the software for the configuration, the firmware download and for the diagnosis, note the following notice:</p> <p>Important! The <u>USB interface</u>, the <u>serial interface</u> as well as the <u>cifX Device Driver</u> may only be used exclusively by one software, that is</p> <ul style="list-style-type: none"> - the SYCON.net configuration software (with integrated ODMV3) or - the netX Configuration Tool or - the cifX Test Application or - the cifX Driver Setup Utility or - the application program. <p>Never use the listed software simultaneously, otherwise this will result in communication problems with the device.</p> <p>If the SYCON.net configuration software was used on the PC, then stop the ODMV3 service before you use one of the other software listed above. Therefore, select Service > Stop from the context menu of the ODMV3 system tray icon.</p>		
Firmware Download	<p>3. Using the configuration software SYCON.net or for the Slave alternatively the Slave configuration tool netX Configuration Tool, the user must select and download the firmware to the PC card cifX.</p>		
Parameter Setting	<p>4. The PC card cifX must be parameterized using one of the following options:</p> <ul style="list-style-type: none"> • Configuration Software SYCON.net • alternatively Slave configuration tool netX Configuration Tool (only Slave) • Application program (programming required) 		
Communication	<p>5. For the communication of a PC card cifX (Slave) a Master device for the respective communication system is required. For the communication of a PC card cifX (Master) a Slave device for the respective communication system is required.</p>		
PC Settings for PC Cards cifX PCI Express	<p>Important! If you install a PC card cifX PCI Express, you <u>always</u> must disable the Microsoft Windows "Link State Power Management". Otherwise, it cannot be excluded that your PC freezes during the PC card cifX PCI Express is in operation.</p>		
Hardware Installation	<p>Important! Operating the PC cards cifX with Cable Connector Ethernet or with the Cable Connector Fieldbus (label "F" in its device name) requires proper connection of the Ethernet (AIFX-RE or AIFX-REIM12), PROFIBUS (AIFX-DP), CANopen (AIFX-CO), DeviceNet (AIFX-DN) or CC-Link (AIFX-CC) detached network interface to the basic card! For 2-channel devices both detached network interfaces must be connected.</p>		
Environmental Conditions	<p>Due to a plug element from ERNI the lower limit of the operating temperature for all PC cards cifX Real-Time Ethernet is 0 °C. This applies to all hardware revisions of the PC card cifX Real-Time Ethernet, unless otherwise stated.</p>		

Table 29: Requirements to operate PC Cards cifX properly

5.2.1 Requirements „DMA Mode“

For device revisions providing the **DMA Mode** the required versions of the firmware, the driver and the SYCON.net setup must be used.

PC Cards with one Channel:

PC Card cifX	From Hardw. Rev.	Firmware File	Protocol	From Firmware Version
CIFX 80-RE,	1	C020Y000.NXF	CC-Link IE Field-Basic-Slave	1.1
CIFX 90-RE\F,	1	CIFXECM.NXF	EtherCAT-Master	4.3 (V4)
CIFX 90-RE\F\M12,	1	CIFXECM.NXF	EtherCAT-Master	2.4.6 (V2)
CIFX 90E-RE\F,	A	CIFXECS.NXF	EtherCAT-Slave	4.5 (V4)
CIFX 90E-RE\F\M12,	A	CIFXECS.NXF	EtherCAT-Slave	2.5.5 (V2)
CIFX 90E-RE\NHS\F,	1	CIFXECS.NXF	EtherCAT-Slave	2.5.5 (V2)
CIFX 90E-RE\NHS\F\M12,	1	CIFXEIM.NXF	EtherNet/IP-Scanner	2.2
CIFX 90E-RE\ET\F,	1	CIFXEIS.NXF	EtherNet/IP-Adapter	2.3
CIFX 90E-RE\ET\F\M12,	1	CIFXOMB.NXF	Open-Modbus/TCP	2.4
CIFX 90E-RE\MR\F,	1	CIFXPLS.NXF	POWERLINK-Controlled-Node	2.1.24
CIFX 90E-RE\MR\F\M12,	1	CIFXPLS.NXF	POWERLINK-Controlled-Node	2.1.24
CIFX 90E-RE\MR\ET\F,	1	C010C000.NXF	PROFINET IO-Controller	3.2 (V3)
CIFX 90E-RE\MR\ET\F\M12,	1	CIFXPNM.NXF	PROFINET IO-Controller	2.3 (V2)
CIFX 104C-RE,	1	CIFXPNS.NXF	PROFINET IO-Device	3.4 (V3)
CIFX 104C-RE-R,	1	CIFXPNS.NXF	PROFINET IO-Device	3.4 (V3)
CIFX 104C-RE\F,	1	CIFXS3M.NXF	Sercos Master	2.0.15
CIFX 104C-RE\F\M12,	1	CIFXS3S.NXF	Sercos Slave	3.0.15
CIFX 104C-RE-R\F,	1	CIFXVRS.NXF	VARAN-Client	1.0
CIFX 104C-RE-R\F\M12,	1	CIFXVRS.NXF	VARAN-Client	1.0
CIFX 80-DP,	1	CIFXDPM.NXF	PROFIBUS DP-Master	2.3
CIFX 90-DP\F,	1	CIFXDPS.NXF	PROFIBUS DP-Slave	2.3
CIFX 90E-DP\F,	5	CIFXMPI.NXF	PROFIBUS MPI Device	<i>not supported</i>
CIFX 90E-RDP\NHS\F,	1	CIFXMPI.NXF	PROFIBUS MPI Device	<i>not supported</i>
CIFX 90E-DP\ET\F,	1	CIFXMPI.NXF	PROFIBUS MPI Device	<i>not supported</i>
CIFX 90E-DP\MR\F,	1	CIFXMPI.NXF	PROFIBUS MPI Device	<i>not supported</i>
CIFX 90E-DP\MR\ET\F,	1	CIFXMPI.NXF	PROFIBUS MPI Device	<i>not supported</i>
CIFX 104C-DP,	1	CIFXMPI.NXF	PROFIBUS MPI Device	<i>not supported</i>
CIFX 104C-DP-R,	1	CIFXMPI.NXF	PROFIBUS MPI Device	<i>not supported</i>
CIFX 104C-DP\F,	1	CIFXMPI.NXF	PROFIBUS MPI Device	<i>not supported</i>
CIFX 104C-DP-R\F,	1	CIFXMPI.NXF	PROFIBUS MPI Device	<i>not supported</i>
CIFX 80-CO,	1	CIFXCOM.NXF	CANopen-Master	2.3
CIFX 90-CO\F,	1	CIFXCOS.NXF	CANopen-Slave	2.3
CIFX 90E-CO\F,	4	CIFXCOS.NXF	CANopen-Slave	2.3
CIFX 90E-CO\NHS\F,	1	CIFXCOS.NXF	CANopen-Slave	2.3
CIFX 90E-CO\ET\F,	1	CIFXCOS.NXF	CANopen-Slave	2.3
CIFX 90E-CO\MR\F,	1	CIFXCOS.NXF	CANopen-Slave	2.3
CIFX 90E-CO\MR\ET\F,	1	CIFXCOS.NXF	CANopen-Slave	2.3
CIFX 104C-CO,	1	CIFXCOS.NXF	CANopen-Slave	2.3
CIFX 104C-CO-R,	1	CIFXCOS.NXF	CANopen-Slave	2.3
CIFX 104C-CO\F,	1	CIFXCOS.NXF	CANopen-Slave	2.3
CIFX 104C-CO-R\F,	1	CIFXCOS.NXF	CANopen-Slave	2.3
CIFX 80-DN,	1	CIFXDNM.NXF	DeviceNet-Master	2.2
CIFX 90-DN\F,	1	CIFXDNS.NXF	DeviceNet-Slave	2.2
CIFX 90E-DN\F,	4	CIFXDNS.NXF	DeviceNet-Slave	2.2
CIFX 90E-DN\NHS\F,	1	CIFXDNS.NXF	DeviceNet-Slave	2.2
CIFX 90E-DN\ET\F,	1	CIFXDNS.NXF	DeviceNet-Slave	2.2
CIFX 90E-DN\MR\F,	1	CIFXDNS.NXF	DeviceNet-Slave	2.2
CIFX 90E-DN\MR\ET\F,	1	CIFXDNS.NXF	DeviceNet-Slave	2.2
CIFX 104C-DN,	1	CIFXDNS.NXF	DeviceNet-Slave	2.2
CIFX 104C-DN-R,	1	CIFXDNS.NXF	DeviceNet-Slave	2.2
CIFX 104C-DN\F,	1	CIFXDNS.NXF	DeviceNet-Slave	2.2
CIFX 104C-DN-R\F,	1	CIFXDNS.NXF	DeviceNet-Slave	2.2
CIFX 90-CC\F,	1	CIFXCPS.NXF	CC-Link Slave	2.4
CIFX 90E-CC\NHS\F,	1	CIFXCPS.NXF	CC-Link Slave	2.4
CIFX 90E-CC\ET\F,	1	CIFXCPS.NXF	CC-Link Slave	2.4
CIFX 90E-CC\MR\ET\F,	1	CIFXCPS.NXF	CC-Link Slave	2.4
CIFX 104C-CC\F,	1	CIFXCPS.NXF	CC-Link Slave	2.4

Table 30: Firmware Versions for the DMA Mode (for 1 Channel Systems)

PC Cards PCI and PCI Express with two Channels:

PC Card cifX	From Hardw. Rev.	Firmware File	Protocol	From Firmware Version
CIFX 90E-2DP\ET\F CIFX 90E-2DP\MR\ET\F	1	CIFX2DPM.NXF	PROFIBUS DP Master, 2 Channels	1.0 (new version counting)
		CIFX2DPS.NXF	PROFIBUS DP Slave, 2 Channels	1.0 (new version counting)
		C0201020.NXF	PROFIBUS DP-Master, 1 Channel + PROFIBUS DP Slave, 1 Channel	1.1
CIFX 90E-2DP\CO\ET\F CIFX 90E-2DP\CO\MR\ET\F	1	C0201040.NXF	PROFIBUS DP Master, 1 Channel + CANopen Master, 1 Channel	1.0
		C0202050.NXF	PROFIBUS DP Slave, 1 Channel + CANopen Slave, 1 Channel	1.0
CIFX 90E-2DP\DN\ET\F CIFX 90E-2DP\DN\MR\ET\F	1	C0201060.NXF	PROFIBUS DP Master, 1 Channel + DeviceNet Master, 1 Channel	1.0
		C0202070.NXF	PROFIBUS DP Slave, 1 Channel + DeviceNetSlave, 1 Channel	1.0
CIFX 90E-2CO\ET\F CIFX 90E-2CO\MR\ET\F	1	C0204040.NXF	CANopen Master, 2 Channels	1.0
		C0205050.NXF	CANopen Slave, 2 Channels	1.0
		C0204050.NXF	CANopen Master, 1 Channel + CANopen Slave, 1 Channel	1.0
CIFX 90E-2CO\DN\ET\F CIFX 90E-2CO\DN\MR\ET\F	1	C0204060.NXF	CANopen Master, 1 Channel + DeviceNet Master, 1 Channel	1.0
		C0205070.NXF	CANopen Slave, 1 Channel + DeviceNet Slave, 1 Channel	1.0
CIFX 90E-2DN\ET\F CIFX 90E-2DN\MR\ET\F	1	C0206060.NXF	DeviceNet Master, 2 Channels	1.0
		C0207070.NXF	DeviceNet Slave, 2 Channels	1.0
		C0206070.NXF	DeviceNet-Master, 1 Channel + DeviceNet-Slave, 1 Channel	1.2

Table 31: Firmware Versions for the DMA Mode (for 2 Channel Systems)

Driver and Software	Version or higher
cifX Device Driver	cifX Device Driver Setup.exe 0.95x
SYCON.net	SYCONnet netX setup.exe V1.201

Table 32: Versions Driver and SYCON.net for the DMA Mode

5.3 Prerequisites for Certification

5.3.1 PROFINET IO Certification for IRT and SYNC0 Signal

5.3.1.1 Providing SYNC0 Signal at SYNC Connector of the PC Card cifX



Note: A PROFINET IO certification for PROFINET IRT requires (mandatory) that your PC card cifX offers the synchronization signal (SYNC0), in order to allow e. g. connecting an oscilloscope. Therefore the SYNC connector of your PC card cifX must be accessible.

Information about where the SYNC connector is placed on your PC card cifX, you can find in the chapter *Device Drawings* on page 34.

5.3.1.2 Using the SYNC0 Signal at the Host System

*Only valid for
PC Cards Mini PCI Express CIFX 90E-XXMR1F or
PC Cards Mini PCI Express CIFX 90E-XXMR1ET1F*

If you forward the SYNC0 signal of your PC card cifX Mini PCI Express to the Mini PCI Express bus X2, you must adhere to the following design specification:



Note: A PROFINET IO certification for PROFINET IRT requires (mandatory) that the host system offers a connector for the synchronization signal (SYNC0), in order to allow e. g. connecting an oscilloscope.

For this purpose you must use the SYNC0 signal and mass of the Mini PCI Express bus X2 of the PC card cifX Mini PCI Express at the host system and provide it at the host system via a well accessible 2-pin connector.

The PC card cifX Mini PCI Express provides the SYNC0 signal *SYNC0*. The SYNC0 signal is provided at pin 46 of the Mini PCI Express bus X2. For the pin assignment of the Mini PCI Express bus X2, refer to section *Pin Assignment for Mini PCI Express Bus / SYNC Connector (Bootstart), X1/X2* on page 158.

The SYNC0 signal has LVTTTL level (3.3 V). A maximum load of 6 mA must not be exceeded.

You should keep the cable length for the sync signals below 50 mm and take into account EMC aspects.

6 Installation, Commissioning and Uninstalling

To install / uninstall the PC cards cifX **Compact PCI**

- CIFX 80-RE
- CIFX 80-DP

Mini PCI

- CIFX 90-RE\F
- CIFX 90-RE\F\M12
- CIFX 90-DP\F
- CIFX 90-CO\F
- CIFX 90-DN\F
- CIFX 90-CC\F

- CIFX 80-CO
- CIFX 80-DN

Mini PCI Express

- CIFX 90E-RE\F
- CIFX 90E-RE\F\M12
- CIFX 90E-DP\F
- CIFX 90E-CO\F
- CIFX 90E-DN\F
- CIFX 90E-RE\NHS\F
- CIFX 90E-RE\NHS\F\M12
- CIFX 90E-DP\NHS\F
- CIFX 90E-CO\NHS\F
- CIFX 90E-DN\NHS\F
- CIFX 90E-CC\NHS\F
- CIFX 90E-RE\ET\F
- CIFX 90E-RE\ET\F\M12
- CIFX 90E-DP\ET\F
- CIFX 90E-CO\ET\F
- CIFX 90E-DN\ET\F
- CIFX 90E-CC\ET\F
- CIFX 90E-RE\MR\F
- CIFX 90E-RE\MR\F\M12
- CIFX 90E-DP\MR\F
- CIFX 90E-CO\MR\F
- CIFX 90E-DN\MR\F
- CIFX 90E-RE\MR\ET\F
- CIFX 90E-RE\MR\ET\F\M12
- CIFX 90E-2DP\ET\F
- CIFX 90E-2DP\CO\ET\F
- CIFX 90E-2DP\DN\ET\F
- CIFX 90E-2CO\ET\F
- CIFX 90E-2CO\DN\ET\F
- CIFX 90E-2DN\ET\F
- CIFX 90E-2DP\MR\ET\F
- CIFX 90E-2DP\CO\MR\ET\F
- CIFX 90E-2DP\DN\MR\ET\F
- CIFX 90E-2CO\MR\ET\F
- CIFX 90E-2CO\DN\MR\ET\F
- CIFX 90E-2DN\MR\ET\F

and **PCI-104**

- CIFX 104C-RE
- CIFX 104C-RE-R
- CIFX 104C-RE\F
- CIFX 104C-RE\F\M12
- CIFX 104C-RE-R\F
- CIFX 104C-RE-R\F\M12
- CIFX 104C-DP
- CIFX 104C-DP-R
- CIFX 104C-DP\F
- CIFX 104C-DP-R\F
- CIFX 104C-CO
- CIFX 104C-CO-R
- CIFX 104C-CO\F
- CIFX 104C-CO-R\F
- CIFX 104C-DN
- CIFX 104C-DN-R
- CIFX 104C-DN\F
- CIFX 104C-DN-R\F
- CIFX 104C-CC\F

handle as described in the sections hereafter. The device drawing of your PC card cifX gives information on the manual control elements of your device.





For the installation, uninstalling and replacement of the PC card cifX **adhere to the necessary safety precautions** given in the safety chapter.

6.1 Overview on Installation and Configuration

The following table describes the steps for the software and hardware installation and for the configuration of a PC card cifX Compact PCI, Mini PCI, Mini PCI Express and PCI-104 (Master and Slave) Real-Time Ethernet and fieldbus as it is typical for many cases. The Slave device can be configured using the corresponding Slave DTM in the configuration software **SYCON.net**. Alternatively, you can also use the simple Slave configuration tool **netX Configuration Tool**. The Master device can be configured using the corresponding Master DTM in the configuration software **SYCON.net**.

#	Step	Description	For detailed information see manual / section	Page
1	Installing Driver and Software			
1.1	Installing cifX Device Driver	<ul style="list-style-type: none"> - Download the Communication Solutions DVD as ZIP file to the local hard disk of your PC. - Unzip the ZIP file. - Double-click the *.exe file in the root directory of the DVD to open the autostart menu. - Follow to the instructions of the installation wizard, to install the driver. 	<i>Refer to User Manual Software Installation for the PC Cards cifX</i>	
1.2	Installing USB Driver Depending by device type / features	<u>Only for PC Cards cifX Compact PCI, PCI-104 equipped with an USB interface or with the diagnostic detached network interface (AIFX-DIAG)</u>		
1.3	Installing SYCON.net	<u>For PC Cards cifX Master or Slave:</u> Run the SYCON.net-Setup and follow to the instructions of the installation wizard.		
1.4	Installing netX Configuration Tool	<u>For PC Cards cifX Slave:</u> Start the netX Configuration Tool setup program to install the netX Configuration Tool .		
2	Preparing Hardware Installation			
2.1	Safety precautions	Observe the necessary precautions for electrostatically sensitive components.	<i>Electrostatic sensitive Devices</i>	60
2.2	Glue sticker on the front plate.	<u>For CIFX 80-RE</u>	<i>Fix Front Plate Sticker at CIFX 80-RE</i>	80
2.3	Set PCI-104 Slot Number .	<u>For PC Cards cifX PCI-104:</u> Set physical PCI-104 Slot Number .	<i>Rotary Switch for PCI-104 Slot Number</i>	143
3	Hardware Installation	Installing cifX. Take required safety precautions.	<i>Installation, Commissioning and Uninstalling</i>	74
3.1	Safety precautions	Take the safety precautions to avoid the risk of injury from electric shock.	<i>Hazardous Voltage, electric Shock</i>	57
3.2	Open cabinet	Now open the cabinet of the PC or of the connection device.	<i>Installing PC Cards cifX Compact PCI,</i>	81,
3.3	Installing cifX	Plug in and mount the PC card cifX.	<i>Installing PC Cards cifX Mini PCI and Mini PCI Express</i>	83

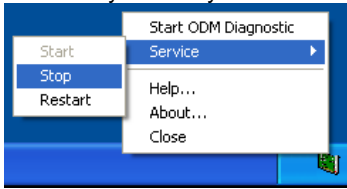
#	Step	Description	For detailed information see manual / section	Page
3.4	If so, plug module	<p><u>For PC Cards cifX PCI-104:</u></p> <p>(a) Install the first PCI-104 module on the mainboard. (b) Install any other PCI-104 module on the respective underlying PCI-104 module.</p>	<i>Installing PC Cards cifX PCI-104</i>	88
3.5	Connect AIFX (only for PC Cards cifX Mini PCI, Mini PCI Express and PCI-104 with label “F” in its device name and with Cable Connector Ethernet X4 or Fieldbus X3)	<p>Important! Operating the PC cards cifX with AIFX detached network interface requires proper connection of the AIFX-RE, AIFX-RE\M12, AIFX-DP, AIFX-CO, AIFX-DN or AIFX-CC detached network interface to the basic card! For 2-channel devices both detached network interfaces must be connected.</p> <p>Note for PC cards cifX with 2 channels, which detached network interface must be connected to the cabel connector fieldbus X3 or X4 (on the PC card cifX).</p> <p>If so, connect an Ethernet (AIFX-RE or AIFX-RE\M12), PROFIBUS (AIFX-DP), CANopen (AIFX-CO), DeviceNet (AIFX-DN) or CC-Link (AIFX-CC) detached network interface.</p> <p>Note! If IP 67 is required: On the Ethernet AIFX-RE\M12 detached network interface, remove the front LED lightpipe and route the LED signals via the cable connector LED signals X3 to the mainboard or a separate detached LED board.</p> <p>If so, additionally connect a diagnostic detached network interface (AIFX-DIAG).</p>	<p><i>The Label „F“ in the Device Name</i></p> <p><i>Table 35: How to assign the detached Network Interfaces for 2-Channel Cards cifX Mini PCI Express</i></p>	13
		<p>To the basic card of each PC card cifX first connect the AIFX-RE, AIFX-RE\M12, AIFX-DP, AIFX-CO, AIFX-DN, AIFX-CC or AIFX-DIAG detached network interface to the PC card cifX and check if the connector is plugged in correctly.</p> <p>For PC cards PCI-104: Only then plug another PCI-104 module.</p>		86
3.6	Close cabinet	Close the cabinet of the PC or connection device.		
3.7	Plug the connecting cable to the Master or Slave	<p><u>Note for all PC Cards cifX Real-Time Ethernet:</u></p> <p>Note! The RJ45 socket is only for use in LAN, not for telecommuni-cation circuits.</p>	<i>Ethernet Interface</i>	138
		<p><u>Note for PC Cards cifX PROFINET IO Controller:</u></p> <p>Important for Hardware Wiring! Connect only ports with each other, which have different cross-over settings. Otherwise a connection between the devices can not be established. If the port settings of the PC card cifX PROFINET IO controller are not set to AUTO, then Port0 is switched uncrossed and Port1 crossed.</p> <p>Plug in the connecting cable from the PC card cifX to the PC card Master or Slave.</p>	<i>See corresponding user manual</i>	
3.8	Connect the PC to the power / switch on.	Connect the PC or the connection device to the power supply and switch it on.		

#	Step	Description	For detailed information see manual / section	Page
4	Hardware Settings	Hardware Settings in the Driver Setup		
4.1	DMA Mode in the cifX Device Driver Setup	Activate the DMA Mode in the cifX Device Driver Setup.	<i>Refer to User Manual Software Installation for the PC Cards cifX</i>	
5	PC Settings			
5.1	for PC Cards cifX PCI Express	Important! If you install a PC card cifX PCI Express, you <u>always</u> must disable the Microsoft Windows "Link State Power Management". Otherwise, it cannot be excluded that your PC freezes during the PC card cifX PCI Express is in operation.	<i>Refer to User Manual Software Installation for the PC Cards cifX</i>	
6	Notice on how to use the Software	Use only one Software.		
6.1	<u>For the configuration, the firmware download and for the diagnosis, note:</u>	Important! To avoid communication problems with the device, use the <u>USB interface</u> , the <u>serial interface</u> as well as the <u>cifX Device Driver</u> exclusively with one software, which is SYCON.net or netX Configuration Tool .	<i>Requirements for Operation of the PC Cards cifX</i>	70
7	Configuring Slave using SYCON.net	Download Firmware and Configuration Use the corresponding Slave DTM in the configuration software SYCON.net .		
7.1	Firmware Download	<ul style="list-style-type: none"> - Start configuration software SYCON.net, - Create new project /Open existing project, - Insert Slave into configuration, - Select driver and assign device. - Select and download the firmware. 	<i>See corresponding user manual</i> <i>Device Names in SYCON.net</i>	95
	<i>Firmware Slave:</i>	CC-Link IE Field Basic Slave, EtherCAT Slave, EtherNet/IP Adapter, Open Modbus/TCP, POWERLINK-Controlled-Node/Slave, PROFINET IO Device, Sercos Slave, VARAN Client, PROFIBUS DP Slave, PROFIBUS MPI Device, CANopen Slave, DeviceNet Slave, CC-Link Slave		
7.2	Configuration cifX (Slave)	-Configure the PC card cifX (Slave).		
7.3	Download Configuration	- Download the configuration to the PC card cifX (Slave)		
8	OR Configuring Slave using netX Configuration Tool	Download Firmware and Configuration		
8.1	Downloading Firmware and Configuration (Slave)	If SYCON.net was already used on the PC, stop the ODMV3 service. Therefore, select Service > Stop from the context menu of the ODMV3 system tray icon.  The ODMV3 system tray icon changes to ODMV3 Service stopped . 	<i>Requirements for Operation of the PC Cards cifX</i>	70

#	Step	Description	For detailed information see manual / section	Page
		In the netX Configuration Tool : <ul style="list-style-type: none"> - select the Firmware protocol, - Set the PC card cifX (Slave) parameters. - Select Apply. The selected firmware and the configuration are downloaded to the replacement card cifX. The configuration is saved to the hard disk of the PC.	<i>See Operating Instruction Manual netX Configuration Tool for cifX, comX and netJACK</i>	
9	Configuring Master using SYCON.net	Download Firmware and Configuration Use the corresponding Master DTM in the configuration software SYCON.net .		
9.1	Firmware Download <i>Firmware Master:</i>	<ul style="list-style-type: none"> - Start configuration software SYCON.net, - Create new project /Open existing project, - Insert Master into configuration, - Select driver and assign device. - Select and download the firmware. EtherCAT Master, PROFIBUS DP Master, EtherNet/IP Scanner, CANopen Master, PROFINET IO DeviceNet Master Controller,	<i>See corresponding user manual Device Names in SYCON.net</i>	95
9.3	Configuration cifX (Master)	- Configure the PC card cifX (Master).	<i>Notes for the Configuration of the Master Device</i>	94
9.4	Download Configuration	- Download the configuration to the PC card cifX (Master).		
10	Diagnosis by SYCON.net (Slave and Master)	Diagnosis, I/O Data Use the corresponding Slave or Master DTM in the configuration software SYCON.net .		
10.1	Diagnosis Steps (Master and Slave)	<ul style="list-style-type: none"> - In netDevice rightclick on device symbol. - Select context menu entry Diagnosis, - then select Diagnosis > General or Firmware Diagnosis, - or select Diagnosis > Extended Diagnosis. 	<i>See corresponding user manual</i>	
10.2	I/O Monitor	<ul style="list-style-type: none"> - In netDevice rightclick on device symbol. - Select context menu entry Diagnosis, - then Tools > IO Monitor. -Check the input or output data. 		
11	OR Slave Diagnosis by netX Configuration Tool (only Slave)	Diagnosis		
11.1	Diagnosis Steps (Slave)	If SYCON.net was already used on the PC, stop the ODMV3 service. Therefore, select Service > Stop from the context menu of the ODMV3 system tray icon. In the netX Configuration Tool : <ul style="list-style-type: none"> - In the navigation area click on Diagnostic, - click in the Diagnostic pane to Start, to start the communication to the Master device and to run the diagnosis. - click on Extended, to run the extended diagnosis. 	<i>See Operating Instruction Manual netX Configuration Tool for cifX, comX and netJACK</i>	

Table 33: Steps for the Software and Hardware Installation, the Configuration and for the Diagnosis of a PC Card cifX Compact PCI, Mini PCI, Mini PCI Express and PCI-104 (Master and Slave)

6.2 Warnings on Installation and Uninstallation

Observe the following warnings when installing, uninstalling and replacing the PC card cifX:



WARNING

Hazardous voltage!
Danger to life, risk of injury by electric shock

Hazardous voltages are present in the PC (or connection device).



- Strictly obey to all safety rules provided by the PC's manufacturer in the documentation!
- First disconnect the power plug of the PC (or connection device), before you open the housing.
- Make sure that the power supply is off at the PC (or connection device).
- Only then open the housing and install or remove the PC card.



NOTICE

Electrostatic sensitive Devices

- Adhere to the necessary safety precautions for components that are vulnerable with electrostatic discharge.
- To prevent damage to the PC and the PC card cifX, make sure, that the PC card cifX is grounded via the endplate and the PC and make sure, that you are discharged when you install/uninstall the PC card cifX.

6.3 Warnings on Installation and Uninstallation (USA)

Observe the following warnings when installing, uninstalling and replacing the PC card cifX:



WARNING

Hazardous voltage!
Danger to life, risk of injury by electric shock



Hazardous voltages are present in the PC (or connection device).

- Strictly obey to all safety rules provided by the PC's manufacturer in the documentation!
- First disconnect the power plug of the PC (or connection device), before you open the housing.
- Make sure that the power supply is off at the PC (or connection device).
- Only then open the housing and install or remove the PC card.

NOTICE



Electrostatic sensitive Devices

- Adhere to the necessary safety precautions for components that are vulnerable with electrostatic discharge.
- To prevent damage to the PC and the PC card cifX, make sure, that the PC card cifX is grounded via the endplate and the PC and make sure, that you are discharged when you install/uninstall the PC card cifX.

6.4 Fix Front Plate Sticker at CIFX 80-RE



Note: Your PC card CIFX 80-RE set contains a set of front plate stickers (9 different stickers). Depending from the loaded firmware the label on each sticker indicates for the respective system the following **LED names:**

- of the **system and communication status LEDs** (*above*)

- of the **RJ45 Ethernet female connector LEDs** (*below*).

Further information to this question you find also in chapter *Diagnosis with LEDs* beginning from page 104.

NOTICE

Electrostatic sensitive Devices

- To prevent damage to the PC and the PC card cifX, make sure, that the PC card cifX is grounded via the endplate and the PC and make sure, that you are discharged when you install/uninstall the PC card cifX.
- Use the sticker according to the firmware and glue it on the front of the PC card CIFX 80-RE.

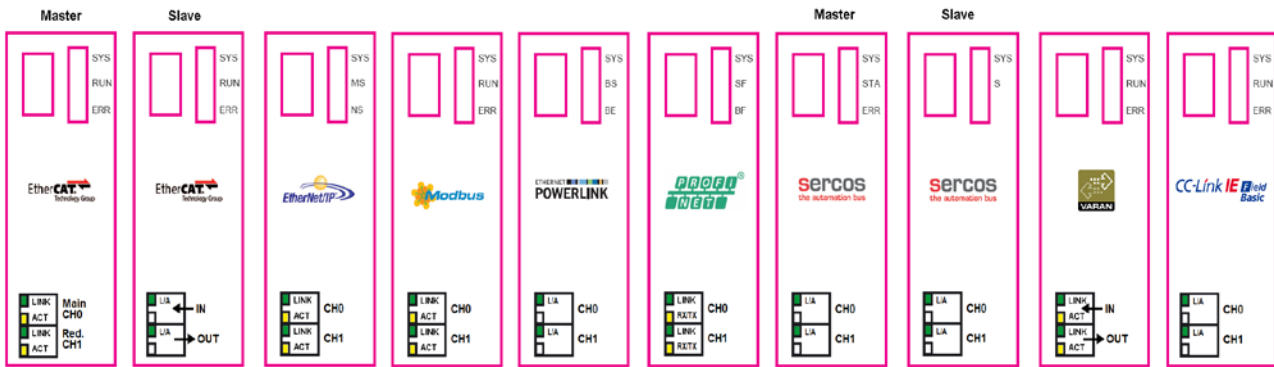

Figure 50: Front Plate Stickers for CIFX 80-RE

LED		EtherCAT Master	EtherCAT Slave	EtherNet/IP	Open Modbus/TCP	POWERLINK	PROFINET IO	Sercos Master	Sercos Slave	VARAN	CC-Link IE Field Basic
SYS (yellow/green)		SYS	SYS	SYS	SYS	SYS	SYS	SYS	SYS	SYS	SYS
COM 0 (red/green)		RUN	RUN	MS	RUN	BS	SF	STA	S	RUN	RUN
COM 1 (red/green)		ERR	ERR	NS	ERR	BE	BF	ERR	-	ERR	ERR
RJ45 Ch0	green	LINK	L/A IN	LINK	LINK	L/A	LINK	L/A	L/A	LINK IN	L/A
	yellow	ACT	-	ACT	ACT	-	RX/TX	-	-	ACT IN	-
RJ45 Ch1	green	LINK	L/A OUT	LINK	LINK	L/A	LINK	L/A	L/A	LINK OUT	L/A
	yellow	ACT	-	ACT	ACT	-	RX/TX	-	-	ACT OUT	-

Table 34: LED Labeling depending of the loaded Firmware

6.5 Installing PC Cards cifX Compact PCI

1. Adhere to the necessary safety precautions for components that are vulnerable with electrostatic discharge.

NOTICE

Electrostatic sensitive Devices

- To prevent damage to the PC and the PC card cifX, make sure, that the PC card cifX is grounded via the endplate and the PC and make sure, that you are discharged when you install/uninstall the PC card cifX.
2. Fix front plate sticker (only for CIFX 80-RE).
 - Use the sticker according to the firmware and glue it on the front of the PC card CIFX 80-RE (see section *Fix Front Plate Sticker at CIFX 80-RE* on page 80).
 3. Take safety precautions.

⚠ WARNING

Hazardous voltage!

Danger to life, risk of injury by electric shock

- Disconnect the power plug of the PC (or connection device).
 - Make sure that the power supply is off at the PC (or connection device).
4. Open cabinet.
 - Open the cabinet of the PC or of the connection device.
 5. Install PC card cifX **Compact PCI**.
 - Possibly remove a blank plate.
 - Put down the ejection lever at the PC card cifX.
 - Plug the PC card cifX into a free Compact PCI slot.
 - Fasten the PC card cifX.
 - Tip up the lever and click in.
 - Screw the PC card cifX with two screws on the wholes above and below.

After this:

6. Close cabinet.
 - Close the cabinet of the PC or connection device.
7. Plug the connecting cable to the Master or Slave.
 - For the PC Cards cifX Real-Time Ethernet with RJ45 connectors note:



Note: The RJ45 socket is only for use in LAN, not for telecommunication circuits. For further information refer to section *Ethernet Interface* on page 138.

- Plug the connecting cable from the PC card cifX to the PC card Master or Slave.

8. Connect the PC or the connection device to the power supply and switch it on.
 - Connect the PC or the connection device to the power supply.
 - Switch on the PC or the connection device.

6.6 Installing PC Cards cifX Mini PCI and Mini PCI Express

1. Requirements

Obey to the installation instructions of the Mini PCI or Mini PCI Express socket manufacturer.

There must be enough space above the socket. During installation, the PC card must not be affected by pressure or other forces.

2. Take safety precautions.

⚠ WARNING

Hazardous voltage!

Danger to life, risk of injury by electric shock

- Disconnect the power plug of the PC (or connection device).
- Make sure that the power supply is off at the PC (or connection device).

NOTICE

Electrostatic sensitive Devices

- To prevent damage to the PC and the PC card cifX, make sure, that the PC card cifX is grounded via the endplate and the PC and make sure, that you are discharged when you install/uninstall the PC card cifX.

3. Open cabinet.

- Open the cabinet of the PC or of the connection device.

4. Install the basic card of the PC card cifX **Mini PCI**.

- Plug the basic card into the Mini PCI socket on the mainboard until it snaps into place.
- Press the clamps on the sides at the Mini PCI socket until they snap into place, to fasten the basic card to the mainboard.

5. Install the basic card of the PC card cifX **Mini PCI Express**.

To mount the basic card in the Mini PCI Express system connector, proceed as follows:

- Plug the basic card into the Mini PCI Express system connector approx. at a 25° angle without tilting it.

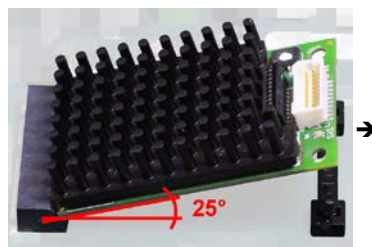

Figure 51: Insertion angle approx. 25° (example)

- Place the finger centrally on the edge of the heat sink (*see figure*).



Figure 52: Press down the basic card with light pressure (max. 2 N) (example)

- Guide the basic card downwards with light pressure (max. 2 N).

Depending on the type of fastening:

- **Locking hooks**
 - Guide the basic card when snapping in (see in figure), because of, the locking hooks could tilt.

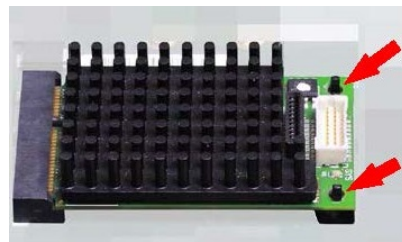

Figure 53: Example: Fastening with locking hooks, guide basic card when snap-in

- **Screw**
 - Screw on the basic card to the main board.
- **Clamps**
 - Press down the clamps until they snap into place.

Connect AIFX detached Network Interface



Important! Operating the PC cards **Mini PCI** CIFX 90-RE\F, CIFX 90-RE\F\M12, CIFX 90-DP\F, CIFX 90-CO\F and CIFX 90-DN\F or the PC cards **Mini PCI Express** CIFX 90E-XX\F (all variants 'NHS', 'ET', 'MR' or with 'M12')⁴ requires proper connection of the Ethernet (AIFX-RE or AIFX-RE\M12), PROFIBUS (AIFX-DP), CANopen (AIFX-CO), DeviceNet (AIFX-DN) or CC-Link (AIFX-CC) detached network interface to the basic card! For 2-channel devices both detached network interfaces must be connected.



Note: If IP 67 is required: On the Ethernet AIFX-RE\M12 detached network interface, remove the front LED lightpipe and route the LED signals via the cable connector LED signals X3 to the mainboard or a separate detached LED board.

6. Mount the detached network interfaces at the housing panel of the PC.

⁴ CIFX 90E-XX\NHS\F, CIFX 90E-XX\ET\F, CIFX 90E-XX\MR\F or CIFX 90E-XX\MR\ET\F (XX = RE, DP, CO, DN or for the variants 'NHS', 'ET' and 'MR\ET' also = CC); or CIFX 90E-RE\F\M12, CIFX 90E-RE\NHS\F\M12, CIFX 90E-RE\ET\F\M12, CIFX 90E-RE\MR\F\M12, CIFX 90E-RE\MR\ET\F\M12

- Install the used AIFX-RE, AIFX-REM12, AIFX-DP, AIFX-CO, AIFX-DN or AIFX-CC detached network interfaces at the housing panel.
- 7. Connect the Ethernet detached network interface (AIFX-RE) or the Ethernet M12 detached network interface (AIFX-RE\M12) to the basic card:
 - Connect the **cable connector Ethernet X1** on the AIFX-RE (or cable connector Ethernet X2 on the AIFX-RE\M12) with the cable.
 - Connect the **cable connector Ethernet X4** on the basic card CIFX 90 or CIFX 90E (all variants 'NHS', 'ET' or 'MR') with the cable.

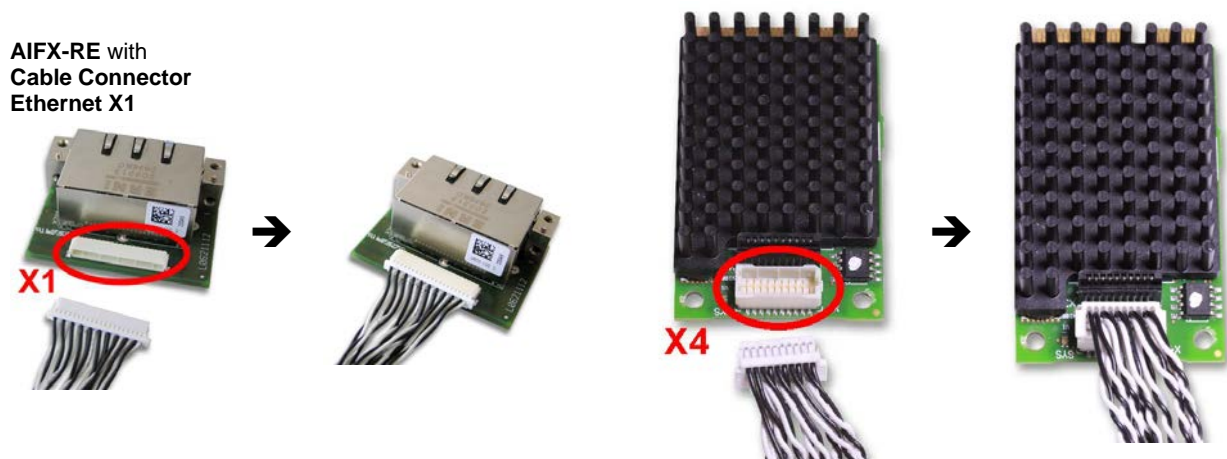
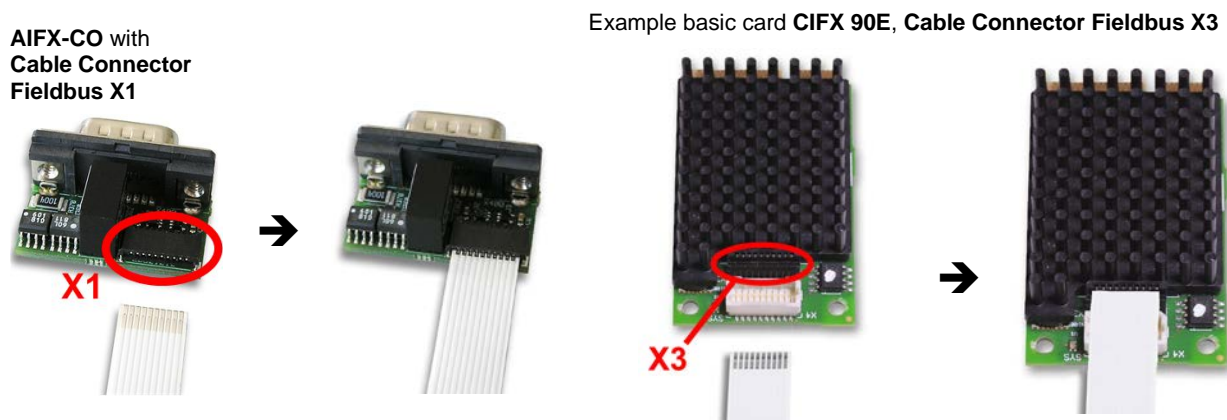

Figure 54: Connecting the detached Network Interface Ethernet (AIFX-RE) to the basic Card CIFX 90E (Example CIFX 90E-REVF with Cable Connector Ethernet X4)

- 8. Alternatively connect the fieldbus detached network interface to the basic card:
 - Connect the **cable connector fieldbus X1** on the AIFX-DP, AIFX-CO, AIFX-DN or AIFX-CC detached network interface with the cable.
 - Connect the **cable connector fieldbus X3** on the basic card CIFX 90 or CIFX 90E (all variants 'NHS', 'ET' or 'MR') with the cable.



Important! The contacts on the connection cable must face up!

Figure 55: Connecting the CANopen detached Network Interface (AIFX-CO) to the basic Card CIFX 90E (Example)

- 9. Connect the fieldbus detached network interface to the basic card for the PC cards cifX with 2 channels:

- Connect the **cable connector fieldbus X1** on the used AIFX-DP, AIFX-CO or AIFX-DN detached network interface with the cable.
- Connect the **cable connector fieldbus X3** and the **cable connector fieldbus X4** on the basic card CIFX 90E-2FB\ET or CIFX 90E-2FB\MR\ET with the cable.

Example basic card **CIFX 90E-2FB\ET**, **Cable Connector Fieldbus X3** and **X4**

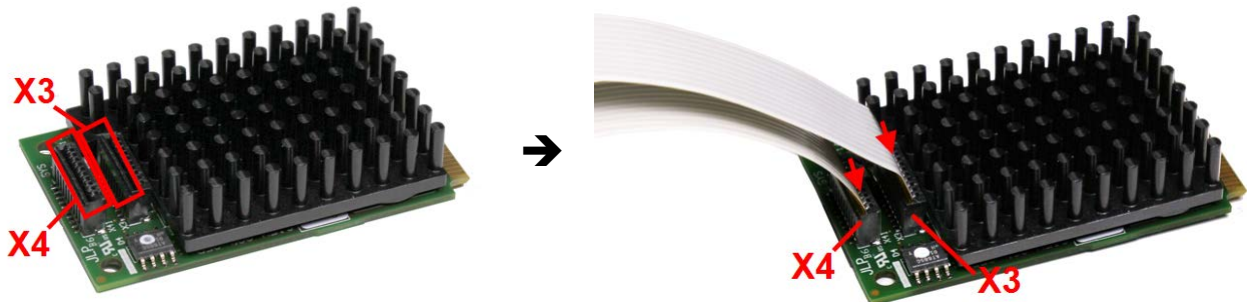

Figure 56: PC Cards cifX Mini PCI Express with 2 Channels: How to connect the detached Network Interfaces to the Basic Card (Example CIFX 90E-2FB\ET)



Important: For PC cards cifX Mini PCI Express with two channels and two different fieldbus systems (PROFIBUS/CANopen, PROFIBUS/DeviceNet or CANopen/DeviceNet) the detached network interfaces AIFX-DP, AIFX-CO or AIFX-DN must be connected to the cable connectors fieldbus X3 or X4 as it is listed in the following table.

PC Card cifX	Basic Card	Cable Connector Fieldbus X3	Cable Connector Fieldbus X4
CIFX 90E-2DP\CO\ET\F	CIFX 90E-2FB\ET	AIFX-DP	AIFX-CO
CIFX 90E-2DP\CO\MR\ET\F	CIFX 90E-2FB\MR\ET		
CIFX 90E-2DP\DN\ET\F	CIFX 90E-2FB\ET	AIFX-DP	AIFX-DN
CIFX 90E-2DP\DN\MR\ET\F	CIFX 90E-2FB\MR\ET		
CIFX 90E-2CO\DN\ET\F	CIFX 90E-2FB\ET	AIFX-CO	AIFX-DN
CIFX 90E-2CO\DN\MR\ET\F	CIFX 90E-2FB\MR\ET		

Table 35: How to assign the detached Network Interfaces for 2-Channel Cards cifX Mini PCI Express

After this:

10. Close cabinet.

- Close the cabinet of the PC or connection device.



Note:

- When mounting the PC case cover, make sure that nothing is trapped between the heat sink of the basic card and the case cover. Do not lay the connection cable of the detached network interface between the housing cover and the heat sink.
- Do not fix the cables to the basic card.

11. Plug the connecting cable to the Master or Slave.

- For the PC cards CIFX 90-RE\F or CIFX 90E-RE\F (all variants with RJ45 connectors) note:



Note: The RJ45 socket is only for use in LAN, not for telecommunication circuits. For further information refer to section *Ethernet Interface* on page 138.

- Plug the connecting cable from the PC card cifX to the PC card Master or Slave.
12. Connect the PC or the connection device to the power supply and switch it on.
- Connect the PC or the connection device to the power supply.
 - Switch on the PC or the connection device.

6.7 Installing PC Cards cifX PCI-104 (PCI-104-Modules)



Note: For PC cards cifX PCI-104 with AIFX detached network interface first install the basic card. Then connect the AIFX detached network interface to the basic card.

1. Adhere to the necessary safety precautions for components that are vulnerable with electrostatic discharge.

NOTICE

Electrostatic sensitive Devices

- To prevent damage to the PC and the PC card cifX, make sure, that the PC card cifX is grounded via the endplate and the PC and make sure, that you are discharged when you install/uninstall the PC card cifX.
2. Set the physical PCI-104 Slot Number.
 - Set the physical PCI-104 Slot Number for each PCI-104 module. For the PC cards cifX PCI-104 use the **Rotary Switch for PCI-104 Slot Number** on the PC card cifX.



Note: At maximum four PCI-104 modules can be plugged one upon the other and each switch position may only be used once. The PCI-104 module plugged next to the host controller gets the CLK number 0, the following PCI-104 modules respectively get the next higher CLK number. For further information refer to section *Rotary Switch for PCI-104 Slot Number* on page 143.

3. Take safety precautions.

⚠ WARNING

Hazardous voltage!

Danger to life, risk of injury by electric shock

- Disconnect the power plug of the PC (or connection device).
 - Make sure that the power supply is off at the PC (or connection device).
4. Open cabinet.
 - Open the cabinet of the PC or of the connection device.



Note: If several PCI-104 modules shall be put together in a stack:

(a) Install the first PCI-104 module on the mainboard.

(b) Only for the basic cards CIFX 104C-RE\F and CIFX 104C-RE-R\F or the basic cards CIFX 104C-FB\F and CIFX 104C-FB-R\F: Connect the AIFX-RE, AIFX-RE\M12, AIFX-DP, AIFX-CO, AIFX-DN, AIFX-CC detached network interface and respectively AIFX-DIAG to the basic card for the first PCI-104 module.

(c) Connect any other PCI-104 module on the respective underlying PCI-104 module.

5. Install PC card cifX **PCI-104**.

- Plug the PC card cifX into a free PCI-104 slot (or if so, to the underlying PCI-104 module).

- Fix the PC card cifX using 4 spacing bolts and screws intended to the mainboard (or if so, to the underlying PCI-104 module). The scope of delivery does not include spacing bolts and screws.

Connect AIFX detached Network Interface

Only for the basic cards for CIFX 104C-RE\F and CIFX 104C-RE-R\F or the basic cards CIFX 104C-FB\F and CIFX 104C-FB-R\F:



Note: First connect the AIFX-RE, AIFX-RE\M12, AIFX-DP, AIFX-CO, AIFX-DN or AIFX-CC detached network interface to each basic card PCI-104, before plugging another PCI-104 module. Just so you can check exactly whether the AIFX is properly connected to the basic card.



Important! Operating the PC cards CIFX 104C-XX\F or CIFX 104C-XX-R\F requires proper connection of the Ethernet (AIFX-RE or AIFX-RE\M12), PROFIBUS (AIFX-DP), CANopen (AIFX-CO), DeviceNet (AIFX-DN) or CC-Link (AIFX-CC) detached network interface to the basic card!



Note: If IP 67 is required: On the Ethernet AIFX-RE\M12 detached network interface, remove the front LED lightpipe and route the LED signals via the cable connector LED signals X3 to the mainboard or a separate detached LED board.

6. Mount the detached network interfaces at the housing panel of the PC.
 - Install the used AIFX-RE, AIFX-RE\M12, AIFX-DP, AIFX-CO, AIFX-DN or AIFX-CC detached network interfaces at the housing panel.
7. Connect the Ethernet detached network interface (AIFX-RE or AIFX-RE\M12) to the basic card.
 - Connect the **cable connector Ethernet X1** on the AIFX-RE (or cable connector Ethernet X2 on the AIFX-RE\M12) with the cable.
 - Connect the **cable connector Ethernet X4** (or X304) on the basic card CIFX 104C-RE\F or CIFX 104C-RE-R\F with the cable.

AIFX-RE with Cable Connector Ethernet X1



Example CIFX 104C-RE\F with Cable Connector Ethernet X4



Figure 57: Connecting the Detached Network Interface Ethernet (AIFX-RE) to the Basic Card CIFX 104C-RE\F (Example)

8. Or connect the PROFIBUS (AIFX-DP), CANopen (AIFX-CO), DeviceNet (AIFX-DN) or CC-Link (AIFX-CC) detached network interface to the basic card.
 - Connect the **cable connector fieldbus X1** on the detached network interface with the cable.

- Connect the **cable connector fieldbus X4** (or X304) on the PC card CIFX 104C-FB\F or CIFX 104C-FB-R\F Fieldbus with the cable.

AIFX-CO with Cable Connector Fieldbus X1

Example basic card CIFX 104C-CO-R\F, Cable Connector Fieldbus X4

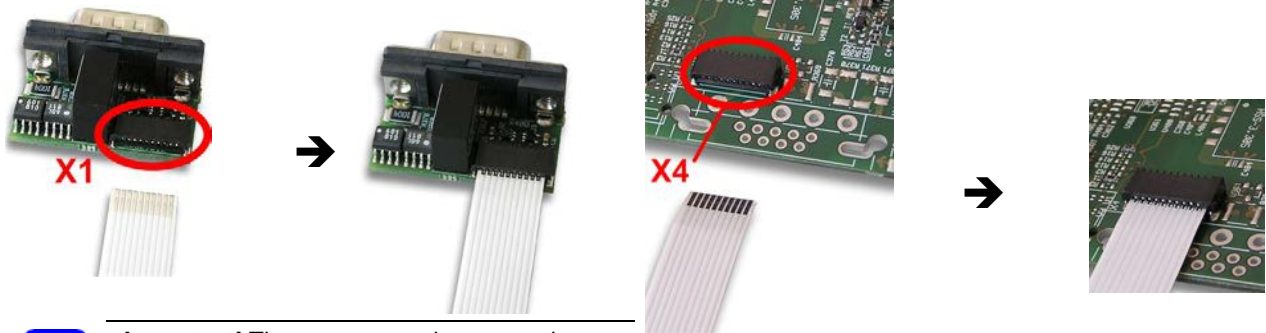

Important! The contacts on the connection cable must face up!

Figure 58: Connecting the CANopen detached Network Interface (AIFX-CO) to the Basic Card 104C-FB-R\F (Example)

Connect AIFX-DIAG

Only for the basic cards for CIFX 104C-RE\F and CIFX 104C-RE-R\F or the basic cards CIFX 104C-FB\F and CIFX 104C-FB-R\F:

9. If so, connect the diagnostic detached network interface (AIFX-DIAG):
 - Connect the **cable connector DIAG X1** on the diagnostic detached network interface (AIFX-DIAG) with the cable.
 - Connect the **cable connector DIAG X3** (or X303) on the PC card cifX with the cable.
 - Install the detached network interface AIFX-DIAG at the front plate of the PC cabinet.

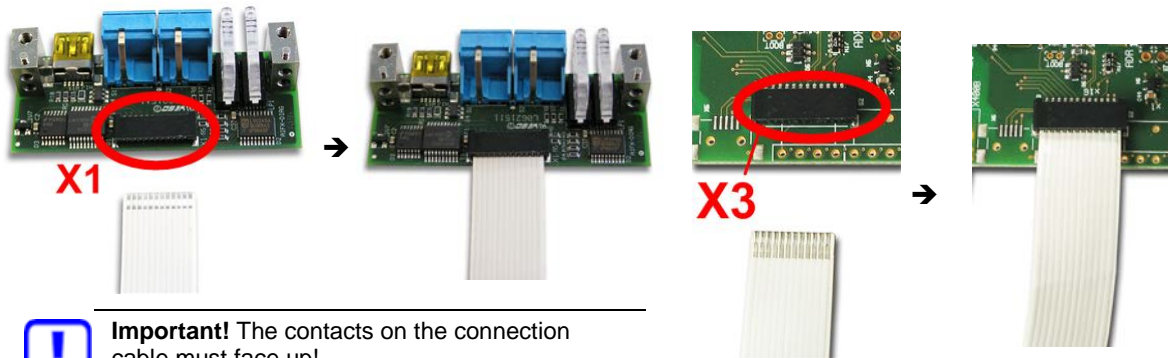

Important! The contacts on the connection cable must face up!

Figure 59: Connecting the Diagnostic detached Network Interface (AIFX-DIAG) to the Basic Card CIFX 104C-FB-R\F (Example)

After this:

10. Close cabinet.
 - Close the cabinet of the PC or connection device.
11. Plug the connecting cable to the Master or Slave.
 - For the PC cards CIFX 104C-RE\F or CIFX 104C-RE-R\F note:



Note: The RJ45 socket is only for use in LAN, not for telecommunication circuits. For further information refer to section *Ethernet Interface* on page 138.

- Plug the connecting cable from the PC card cifX to the PC card Master or Slave.
12. Connect the PC or the connection device to the power supply and switch it on.
- Connect the PC or the connection device to the power supply.
 - Switch on the PC or the connection device.

6.8 Warnings on Firmware or Configuration Download

When downloading the firmware as well as the configuration into the PC card cifX, observe the warnings listed below.



WARNING

Communication Stop caused by Firmware or Configuration Download

Initiating a firmware or configuration download process during bus operation will stop the communication and a subsequent plant stop may cause unpredictable and unexpected behavior of machines and plant components, possibly resulting in personal injury and damage to your equipment.

The firmware download overwrites the existing firmware. The communication stop may cause loss of device parameters and possible device damage may occur.

- Stop the application program, before you start the firmware or configuration download.
 - Make sure that all network devices are placed in a fail-safe condition.
-



NOTICE

Power Disconnect while downloading Firmware or Configuration

If the power supply to the PC or device is interrupted while the firmware or configuration is being downloaded, the download will be aborted, the firmware may be corrupted, the device parameters may be lost, and the device may be damaged.

- During firmware or configuration download process do not interrupt the power supply to the PC, or to the device and do not perform a reset to the device!
-

Not suitable configuration or invalid firmware



WARNING

Mismatching System Configuration

Mismatching system configuration loaded into the device could result in faulty data mapping in the application program and thus unexpected equipment operation may cause personal injury or damage of equipment.

- In the device use only a configuration suitable for the system.
-



NOTICE

Invalid Firmware

Loading invalid firmware files could render your device unusable.

- Only proceed with a firmware version valid for your device.
-

6.9 Warnings on Firmware or Configuration Download (USA)

When downloading the firmware as well as the configuration into the PC card cifX, observe the warnings listed below.

WARNING**Communication Stop caused by Firmware or Configuration Download**

Initiating a firmware or configuration download process during bus operation will stop the communication and a subsequent plant stop may cause unpredictable and unexpected behavior of machines and plant components, possibly resulting in personal injury and damage to your equipment.

The firmware download overwrites the existing firmware. The communication stop may cause loss of device parameters and possible device damage may occur.

- Stop the application program, before you start the firmware or configuration download.
 - Make sure that all network devices are placed in a fail-safe condition.
-

NOTICE**Power Disconnect while downloading Firmware or Configuration**

If the power supply to the PC or device is interrupted while the firmware or configuration is being downloaded, the download will be aborted, the firmware may be corrupted, the device parameters may be lost, and the device may be damaged.

- During firmware or configuration download process do not interrupt the power supply to the PC, or to the device and do not perform a reset to the device!
-

Not suitable configuration or invalid firmware

WARNING**Mismatching System Configuration**

Mismatching system configuration loaded into the device could result in faulty data mapping in the application program and thus unexpected equipment operation may cause personal injury or damage of equipment.

- In the device use only a configuration suitable for the system.
-

NOTICE**Invalid Firmware**

Loading invalid firmware files could render your device unusable.

- Only proceed with a firmware version valid for your device.
-

6.10 Notes for the Configuration of the Master Device

To configure the Master, a device description file is required. Note the following notes for the configuration of the Master Device:

System	Note
<i>CC-Link IE Field Basic Slave</i>	To configure the Master, a CSPP file (device description file) is required. The settings in the used Master must comply with the settings in the Slave to establish communication. Important parameters are: Slave Station Address, Input and output data, , vendor code, model type, occupied stations.
<i>EtherCAT Slave</i>	To configure the Master, an XML file (device description file) is required. The settings in the used Master must comply with the settings in the Slave to establish communication. Important parameters are: Vendor ID, Product Code, Serial Number, Revision Number, Output and Input Data Bytes.
	If the XML file <i>Hilscher cifX RE ECS V2.2.x.xml</i> is use/updated, the firmware with the version 2.2.x must be use/updated.
	The loadable firmware supports for the number of cyclic input data and for cyclic output data in total up to 400 bytes. If more than 200 bytes for input data or for output data should be exchanged via EtherCAT, then a customer specific XML file is necessary. Additionally the following formular applies: $(\text{number of input bytes} + 3)/4 + (\text{number of output bytes} + 3)/4$ must be less or equal to 100.
<i>EtherNet/IP Adapter</i>	To configure the Scanner/Master, an EDS file (device description file) is required. The settings in the used Scanner/Master must comply with the settings in the Adapter/Slave to establish communication. Important parameters are: Input, Output Data Bytes, Vendor ID, Product Type, Product Code, Major Rev, Minor Rev, IP Address and Netmask.
<i>POWERLINK-Controlled-Node/Slave</i>	To configure the Managing Node/Master, an XDD file (device description file) is required. The settings in the used Managing Node/Master must comply with the settings in the Controlled Node/Slave, to establish communication. Important parameters are: Vendor ID, Product Code, Serial Number, Revision Number, Node ID, Output and Input length.
<i>PROFINET IO Device</i>	To configure the Controller, a GSDML file (device description file) is required. The settings in the used Controller must comply with the settings in the Device to establish communication. Important parameters are: Station Name, Vendor ID, Device ID, Input and Output Data Bytes. Under Name of Station, the name must be typed which was also used in the configuration file of the master of this device. If no name chosen freely is used in the configuration file, then the name from the GSDML file is used.
<i>Sercos Slave</i>	The Sercos Master uses the Sercos address to communicate with the slave. Some Masters will verify Device ID, Vendor Code, Input Data Size and Output Data Size and will do further communication to the Slave only if all these values match. Therefore the Master reads these parameters from the Slave and compares them with the configuration stored in the Master. The parameters Device ID, Vendor Code, Input Data Size and Output Data Size are part of the SDDML device description file. If for the configuration of the Sercos Master SDDML files are used and a default value of one of these parameters was changed, then a SDDML file must be created in the configuration software via Export SDDML and then used in the configuration of the SERCOS Master.
<i>PROFIBUS DP Slave</i>	To configure the Master, a GSD file (device description file) is required. The settings in the used Master must comply with the settings in the Slave to establish communication. Important parameters are: Station Address, Ident Number, Baudrate and Config Data (the configuration data for the output and input length).
<i>CANopen Slave</i>	To configure the Master, an EDS file (device description file) is required. The settings in the used Master must comply with the settings in the Slave to establish communication. Important parameters are: Node Address and Baudrate.
<i>DeviceNet Slave</i>	To configure the Master, an EDS file (device description file) is required. The settings in the used Master must comply with the settings in the Slave to establish communication. Important parameters are: MAC ID, Baudrate, Produced Size, Consumed Size, Vendor ID, Product Type, Product Code, Major Rev, Minor Rev.
<i>CC-Link Slave</i>	To configure the Master, a CSP file (device description file) is required. The settings in the used Master must comply with the settings in the Slave to establish communication. Important parameters are: Slave Station Address, Baudrate, Station Type and Vendor Code.

Table 36: Notes for the Configuration of the Master Device



Further information to the device description files you find under section on *Device Description Files cifX* page 26.

6.11 Device Names in SYCON.net

The following table contains the device names displayed for the single communication protocols in the configuration software SYCON.net.

The table shows the PC card cifX and which protocol can be used. Furthermore, the table shows, for which protocol which device must be selected from the device catalog to configure the PC card cifX with SYCON.net.

PC Cards cifX	Protocol	DTM Specific Group	Device Name in SYCON.net
CIFX 80-RE, CIFX 90-RE\F, CIFX 90-RE\F\M12, CIFX 90E-RE\F, CIFX 90E-RE\F\M12, CIFX 90E-RE\NHS\F, CIFX 90E-RE\NHS\F\M12, CIFX 90E-RE\ET\F, CIFX 90E-RE\ET\F\M12, CIFX 90E-RE\MR\F, CIFX 90E-RE\MR\F\M12, CIFX 90E-RE\MR\ET\F, CIFX 90E-RE\MR\ET\F\M12, CIFX 104C-RE, CIFX 104C-RE-R, CIFX 104C-RE\F, CIFX 104C-RE\F\M12, CIFX 104C-RE-R\F, CIFX 104C-RE-R\F\M12	CC-Link IE Field Basic Slave	Gateway/Stand-Alone Slave	CIFX RE/CCIBS
	EtherCAT Master	Master	CIFX RE/ECM
	EtherCAT Slave	Gateway/Stand-Alone Slave	CIFX RE/ECS
	EtherNet/IP Scanner (Master)	Master	CIFX RE/EIM
	EtherNet/IP Adapter (Slave)	Gateway/Stand-Alone Slave	CIFX RE/EIS
	Open Modbus/TCP	Gateway/Stand-Alone Slave	CIFX RE/OMB
	POWERLINK-Controlled-Node/Slave	Gateway/Stand-Alone Slave	CIFX RE/PLS
	PROFINET IO-Controller	Master	CIFX RE/PNM
	PROFINET IO-Device	Gateway/Stand-Alone Slave	CIFX RE/PNS
	Sercos Master	Master	CIFX RE/S3M
	Sercos Slave	Gateway/Stand-Alone Slave	CIFX RE/S3S
	VARAN Client (Slave)	Gateway/Stand-Alone Slave	CIFX RE/VRS
	CIFX 80-DP, CIFX 90-DP\F, CIFX 90E-DP\F, CIFX 90E-DP\NHS\F, CIFX 90E-DP\ET\F, CIFX 90E-DP\MR\F, CIFX 90E-DP\MR\ET\F, CIFX 90E-2DP\ET\F CIFX 90E-2DP\MR\ET\F CIFX 90E-2DP\CO\ET\F CIFX 90E-2DP\CO\MR\ET\F CIFX 90E-2DP\DN\ET\F CIFX 90E-2DP\DN\MR\ET\F CIFX 104C-DP, CIFX 104C-DP-R, CIFX 104C-DP\F, CIFX 104C-DP-R\F	PROFIBUS DP Master	Master
PROFIBUS DP Slave		Gateway/ Stand-Alone Slave	CIFX DP/DPS
PROFIBUS MPI Device		Gateway/ Stand-Alone Slave	CIFX DP/MPI
CIFX 80-CO, CIFX 90-CO\F, CIFX 90E-CO\F, CIFX 90E-CO\NHS\F, CIFX 90E-CO\ET\F, CIFX 90E-CO\MR\F, CIFX 90E-CO\MR\ET\F, CIFX 90E-2CO\ET\F CIFX 90E-2CO\MR\ET\F CIFX 90E-2DP\CO\ET\F CIFX 90E-2DP\CO\MR\ET\F CIFX 90E-2CO\DN\ET\F CIFX 90E-2CO\DN\MR\ET\F CIFX 104C-CO, CIFX 104C-CO-R, CIFX 104C-CO\F, CIFX 104C-CO-R\F	CANopen Master	Master	CIFX CO/COM
	CANopen Slave	Gateway/ Stand-Alone Slave	CIFX CO/COS
CIFX 80-DN, CIFX 90-DN\F, CIFX 90E-DN\F, CIFX 90E-DN\NHS\F, CIFX 90E-DN\ET\F,	DeviceNet Master	Master	CIFX DN/DNM
	DeviceNet Slave	Gateway/ Stand-Alone Slave	CIFX DN/DNS

PC Cards cifX	Protocol	DTM Specific Group	Device Name in SYCON.net
CIFS 90E-DN\MR\F, CIFS 90E-DN\MR\ET\F, CIFS 90E-2DN\ET\F CIFS 90E-2DN\MR\ET\F CIFS 90E-2DP\DN\ET\F CIFS 90E-2DP\DN\MR\ET\F CIFS 90E-2CO\DN\ET\F CIFS 90E-2CO\DN\MR\ET\F CIFS 104C-DN, CIFS 104C-DN-R, CIFS 104C-DN\F, CIFS 104C-DN-R\F			
CIFS 90-CC\F CIFS 90E-CC\NHS\F CIFS 90E-CC\ET\F CIFS 90E-CC\MR\ET\F CIFS 104C-CC\F	CC-Link Slave	Gateway/Stand-Alone Slave	CIFS CC/CCS

Table 37: Device Names in SYCON.net by Communication Protocol

6.12 Update for Firmware, Driver and Software



Note: As a pre-requirement for the software update the project files, the configuration files and firmware files are to be saved.

At existing hardware installation the firmware, the driver and the configuration software must be updated according to the versions given in section *Revision or version status of hardware and software* on page 28. The following graphic gives an overview:

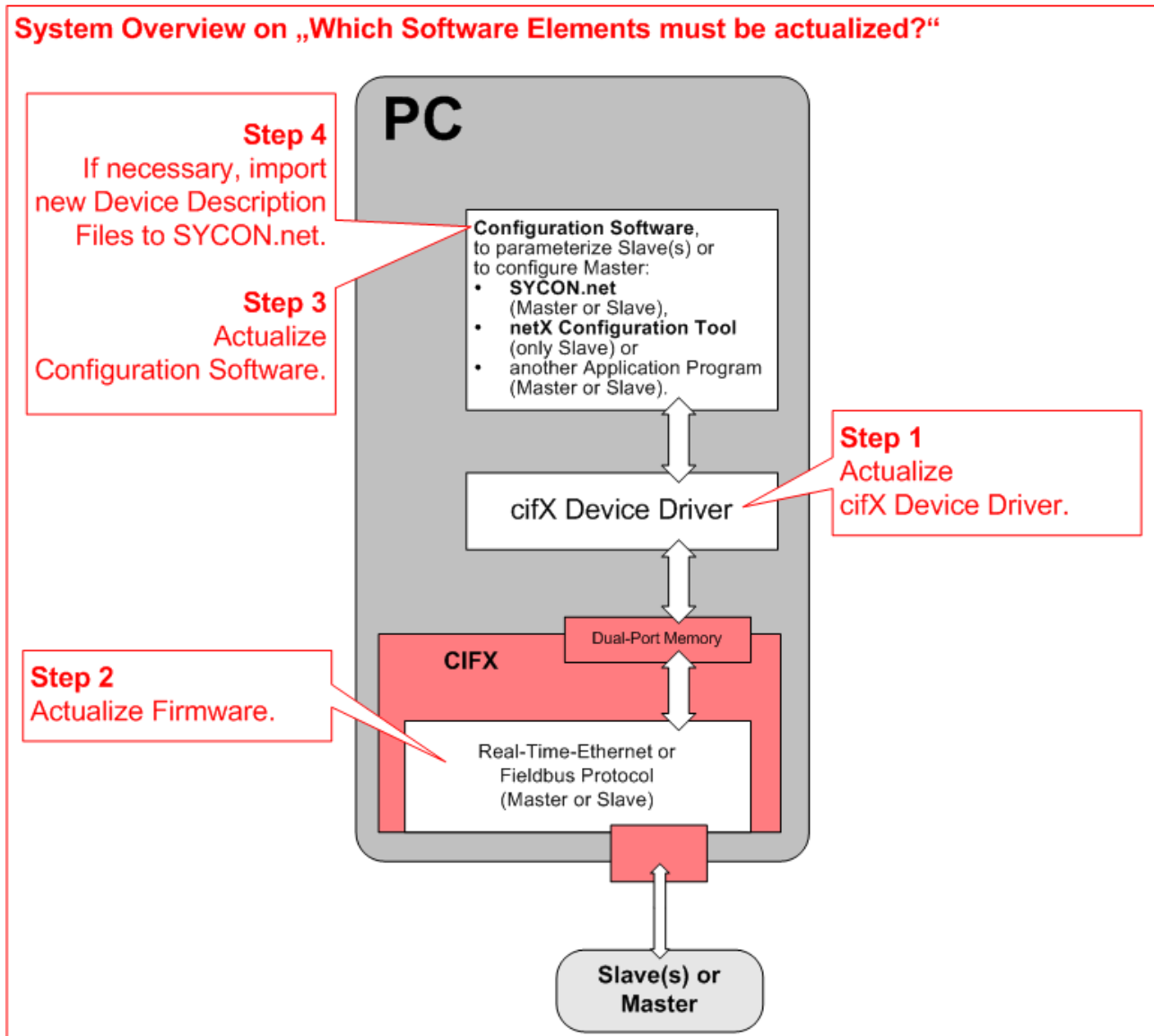

Figure 60: System Overview cifX to update Firmware, Driver and Software



Note the specific details for devices with **DMA Mode** in section *The Function „DMA Mode“* on page 24.

6.13 Instructions for Problem Solving

In case of any error, follow the instructions for problem solving given here:

General

- Check the PC card cifX operating requirements according to the requirements given in the section *Requirements for Operation of the PC Cards cifX* on page 70.

SYS and COM Status LEDs

Troubleshooting of the system is done by examining the LEDs behaviour. The PC cards cifX have depending by card type two or three bicolor status LEDs, which inform the user about the communication state of the device.

- The **SYS** LED shows the common system status of the device. It can be yellow or green ON or it can blink green/yellow.
- The **COM** LEDs display the status of the Real-Time Ethernet or fieldbus communication. Depending by protocol and state, the LEDs can be ON or flash cyclic or acyclic in green or red (or orange).

If the LED SYS lights statically green and the LED COM (or COM0) lights statically green (or possibly is "off"), the PC card cifX is in operational state, the Master is in data exchange with the connected Slaves and the communication is running without fault. The meaning of the LEDs is described in chapter *Diagnosis with LEDs* beginning from page 104.

LINK-LED (for PC cards cifX Real-Time Ethernet)

- Check using the LINK LED's status whether a connection to the Ethernet is established. Therefore use the description on the LINK LED in the chapter *Diagnosis with LEDs* beginning from page 104.

Cable

- Check that the pin assignment of the cable is correct. This means, the cable by which you connect the PC card cifX to the PC card Master or Slave.

Configuration

- Check the configuration in the Master device and the Slave device. The configuration has to match.

Diagnosis

Via **Online > Diagnosis** (for SYCON.net) or **netX Configuration Tool > Diagnostics** (for netX Configuration Tool) the diagnostic information of the device is shown. The shown diagnostic information depends on the used protocol.



Further information about the device diagnosis and its functions you find in the operating instruction manual of the corresponding Real-Time Ethernet or fieldbus system.

6.14 Note on Exchange Service (Replacement Case)

For the exchange service (replacement case) of a PC card cifX (Master and Slave) obey to the following note.



Important! For PC cards cifX in terms of a device exchange service (replacement case) you must manually download the same firmware and configuration into the replacement card cifX, as into the preceding cifX.

6.15 Uninstalling PC Cards cifX Compact PCI

1. Take safety precautions.

WARNING

Hazardous voltage!

Danger to life, risk of injury by electric shock

- Disconnect the power plug of the PC (or connection device).
- Make sure that the power supply is off at the PC (or connection device).

NOTICE

Electrostatic sensitive Devices

- To prevent damage to the PC and the PC card cifX, make sure, that the PC card cifX is grounded via the endplate and the PC and make sure, that you are discharged when you install/uninstall the PC card cifX.
2. Remove the connecting cable to the Master or Slave.
 - Remove the connecting cable between the PC card cifX and the PC card Master or Slave.
 3. Open cabinet.
 - Open the cabinet of the PC or of the connection device.
 4. Uninstall PC card cifX **Compact PCI**.
 - Unscrew the PC card cifX.
 - First press the grey button at the ejection lever.
 - Then press the ejection lever downwards.
 - Remove the PC card cifX from the Compact PCI slot.
 - Possibly reinsert a blank plate.

After this:

5. Close cabinet.
 - Close the cabinet of the PC or connection device.

6.16 Uninstalling PC Cards cifX Mini PCI, Mini PCI Express

1. Take safety precautions.

⚠ WARNING

Hazardous voltage!

Danger to life, risk of injury by electric shock

- Disconnect the power plug of the PC (or connection device).
- Make sure that the power supply is off at the PC (or connection device).

NOTICE

Electrostatic sensitive Devices

- To prevent damage to the PC and the PC card cifX, make sure, that the PC card cifX is grounded via the endplate and the PC and make sure, that you are discharged when you install/uninstall the PC card cifX.
2. Remove the connecting cable to the Master or Slave.
 - Remove the connecting cable between the PC card cifX to be replaced and the PC card Master or Slave.
 3. Open cabinet.
 - Open the cabinet of the PC or of the connection device.

Uninstall AIFX detached Network Interface

4. Uninstall the Ethernet (AIFX-RE or AIFX-RE\M12), PROFIBUS (AIFX-DP), CANopen (AIFX-CO), DeviceNet (AIFX-DN) or CC-Link (AIFX-CC) detached network interface:
 - Remove the AIFX-RE, AIFX-RE\M12, AIFX-DP, AIFX-CO, AIFX-DN or AIFX-CC detached network interface from the housing panel of the PC.
 - Disconnect the cable from the basic card of the PC card cifX Mini PCI or Mini PCI Express; cable connector Ethernet X4 or cable connector fieldbus X3.

Remove PC Card cifX

5. Remove the basic card of the PC card cifX **Mini PCI**:
 - To remove the PC card cifX from the mainboard, pull the clamps on the sides at the Mini PCI socket on the mainboard until the basic card flips up.
 - Remove the basic card from the Mini PCI socket.

Or:

6. Remove the basic card of the PC card cifX **Mini PCI Express**:

To remove the PC card cifX from the mainboard, proceed as follows, depending on the type of mounting (e.g. snap-in hooks, screws, clamps):

- *Snap-in hooks*

Example: Basic card CIFX 90E⁵, fastening with snap-in hooks

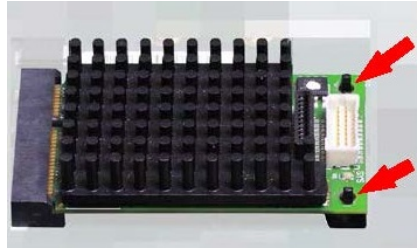

Figure 61: Guide basic card when snapping in

- Guide basic card when snapping in (see in figure), because of, the snap-in hooks could tilt.
- *Screws*
- Unscrew the basic card from the mainboard.
- *Clamps*
- Press down the the fastening clips until the card folds upwards.



Figure 62: Remove PC card cifX from Mini PCI system connector

- Remove the PC card cifX from the PCI Express Mini System Connector.

After this:

7. Close cabinet.
- Close the cabinet of the PC or connection device.

⁵ all variants: CIFX 90E, CIFX 90E\NHS, CIFX 90E\ET, CIFX 90E\MR, CIFX 90E\MR\ET

6.17 Uninstalling PC Cards cifX PCI-104

1. Take safety precautions.

⚠ WARNING

Hazardous voltage! Danger to life, risk of injury by electric shock

- Disconnect the power plug of the PC (or connection device).
- Make sure that the power supply is off at the PC (or connection device).

NOTICE

Electrostatic sensitive Devices

- To prevent damage to the PC and the PC card cifX, make sure, that the PC card cifX is grounded via the endplate and the PC and make sure, that you are discharged when you install/uninstall the PC card cifX.
2. Remove the connecting cable to the Master or Slave.
 - Remove the connecting cable between the PC card cifX to be replaced and the PC card Master or Slave.
 3. Open cabinet.
 - Open the cabinet of the PC or of the connection device.



Note: If a PC card CIFX 104C-XX\F or CIFX 104C-XX-R\F shall be uninstalled from a stack of PCI-104 modules:

- (a) Remove all PCI-104 modules above from the PC card cifX and the PC card cifX. For each PC card cifX first remove the AIFX detached network interfaces from the basic cards.
- (b) Reinstall the removed PCI-104 modules.

Uninstall detached Network Interface AIFX

Only for PC cards PCI-104 with AIFX detached Network Interface CIFX 104C-XX\F and CIFX 104C-XX-R\F:

4. Uninstall the AIFX detached network interface:
 - Remove the detached network interfaces Ethernet (AIFX-RE or AIFX-RE\M12), PROFIBUS (AIFX-DP), CANopen (AIFX-CO), DeviceNet (AIFX-DN), CC-Link (AIFX) and diagnostic (AIFX-DIAG) from the front plate of the PC cabinet.
 - Disconnect the cables from the PC card cifX PCI-104; cable connector Ethernet X4 (or X304) or cable connector fieldbus X4 (or X304) and cable connector DIAG X3 (or X303).

Remove PC Card cifX

5. Remove PC card cifX **PCI-104**.
 - Loosen the four fastening screws of the PC card cifX.
 - Remove the PC card cifX.

After this:

6. Close cabinet.
 - Close the cabinet of the PC or connection device.

6.18 Disposal and recycling of waste electronic equipment

Waste electronic equipment must be disposed of properly after the end of use.



Waste electronic equipment

This product must not be disposed of with household waste.

Dispose of this product in accordance with local regulations in your country.

When disposing of the product, observe the following:

- Observe national and local regulations for the disposal of waste electronic equipment and packaging.
- Delete personal data stored in the waste electronic device.
- Dispose of this product in an environmentally friendly manner at a local collection point for waste electronic equipment.
- Dispose of packaging in such a way that a high level of recycling is possible.

Alternatively, you can return our products to us for disposal. The prerequisite is that no additional foreign substances are contained. Before returning, please contact us via the Return Merchandise Authorization (RMA) form on www.hilscher.com.

In Europe, the directive 2012/19/EU waste electrical and electronic equipment applies. Different policies and laws may apply nationally.

7 Diagnosis with LEDs

The LEDs will be used to indicate status information of the PC card cifX. Each LED has a specific function during Run, configuration download and error indications. The descriptions hereafter show the reaction of each LED for the PC card cifX during these states.

7.1 Overview LEDs Real-Time Ethernet Systems



Note: The meaning of the communication status LEDs and of the Ethernet LEDs at the device is defined by the loaded firmware of the predocol.

LED Naming in the Device Drawing	EtherCAT Master	EtherCAT Slave	EtherNet/IP	Open-Modbus/TCP	POWERLINK	PROFINET IO	Sercos Master	Sercos Slave	VARAN	CC-Link IE Field Basic	
SYS (System Status) ● ● (yellow/green)	SYS	SYS	SYS	SYS	SYS	SYS	SYS	SYS	SYS	SYS	
COM 0 (Communication Status)	RUN ● (green)	RUN ● (green)	MS ● ● (red/green)	RUN ● (green)	BS ● (green)	SF ● (red)	STA ● (green)	S ● ● (red/green/orange)	RUN ● (green)	RUN ● (green)	
COM 1 (Communication Status)	ERR ● (red)	ERR ● (red)	NS ● ● (red/green)	ERR ● (red)	BE ● (red)	BF ● (red)	ERR ● (red)	-	ERR ● (red)	ERR ● (red)	
Ethernet Ch0	● (green)	LINK	L/A IN	LINK	LINK	L/A	LINK	L/A	L/A	LINK IN	L/A
	● (yellow)	ACT	-	ACT	ACT	-	RX/TX	-	-	ACT IN	-
Ethernet Ch1	● (green)	-	L/A OUT	LINK	LINK	L/A	LINK	L/A	L/A	LINK OUT	L/A
	● (yellow)	-	-	ACT	ACT	-	RX/TX	-	-	ACT OUT	-

Table 38: Overview LEDs Real-Time Ethernet Systems

LED	Name	Meaning
System Status	SYS	System Status
Kommunikationsstatus	COM	Communication Status
	RUN	Run
	ERR	Error
	STA	Status
	MS	Module Status
	NS	Network Status
	BS	Bus Status
	BE	Bus Error
	SF	System Failure
	BF	Bus Failure
	S	Status / Error
	Ethernet	LINK, L
ACT, A		Activity
L/A		Link/Activity
L/A IN		Link/Activity Input
L/A OUT		Link/Activity Output
LINK IN		Link Input
LINK OUT		Link Output
ACT IN		Activity Input
ACT OUT		Activity Output
RX/TX		Receive/Transmit

Table 39: LED Names

7.2 Overview LEDs Fieldbus Systems







LED	PROFIBUS DP (1 Duo LED)	PROFIBUS MPI (1 Duo LED)	CANopen (1 Duo LED)	DeviceNet (1 Duo LED)	CC-Link (Slave) (2 LEDs)
System Status  (gelb/green)	SYS	SYS	SYS	SYS	SYS
Communication Status	COM  (red/green)	COM  (green)	CAN  (red/green)	MNS  (red/green)	L RUN  (green) L ERR  (red)

Table 40: Overview LEDs by Fieldbus System for 1 Channel Devices











LED	PROFIBUS DP or PROFIBUS MPI (2 LEDs or 1 AIFX-DP/channel)	CANopen (2 LEDs or 1 AIFX-CO/channel)	DeviceNet (1 Duo LED/ channel)
System Status  (yellow/green)	SYS	SYS	SYS
Communication Status Channel X3 (SYCONnet: Ch0)	ERR0  (red) STA0  (green)	ERR0  (red) RUN0  (green)	MNS0  (red/green)
Channel X4 (SYCONnet: Ch1)	ERR1  (red) STA1  (green)	ERR  (red) RUN  (green)	MNS1  (red/green)

Table 41: Overview LEDs by Fieldbus System for 2 Channel Devices (only PC Cards cifX Mini PCI Express)

LED	Name	Meaning
System Status	SYS	System Status
Communication Status	COM	Communication Status
	RUN	Run
	ERR	Error
	STA	Status
	CAN	CANopen Status
	MNS	Module Network Status
	L RUN / L ERR	Status Run / Status Error

Table 42: LED Names

7.3 System LED

The System Status LED **SYS** can assume the states described below.





LED	Color	State	Meaning
SYS	Duo LED yellow/green		
	 (green)	On	Operating System running
	 (green/yellow)	Blinking, cyclic	Second stage bootloader is waiting for firmware.
	 (yellow)	On	Bootloader netX (= romloader) is waiting for second stage bootloader.
	 (off)	Off	Power supply for the device is missing or hardware defect.

Table 43: System Status LED States

7.4 Power On LED

The power On LED **PWR** can assume the states described below.



LED	Color	State	Meaning
PWR	LED green		
	 (green)	On	Power supply for the device on.
	 (off)	Off	Power supply for the device is missing.

Table 44: Power On LED States

7.5 CC-Link IE Field Basic Slave

For the CC-Link IE Field Basic Slave protocol, the communication LED **RUN/ERR** as well as the Ethernet LED **L/A** can assume the states described below.











LED	Color	State	Meaning
RUN/ERR (Run/Error) General name: COM	Duo LED red/green		
	 (green)	On	Station in operation and cyclic transmission in progress.
	 (green)	Blinking (2.5 Hz)	Station in operation and cyclic transmission stopped.
	 (green)	Flickering (10 Hz)	Station not configured.
	 (red)	On	Communication error.
	 (red)	Blinking	Cable disconnected or no communication with the Master.
	 (red)	Triple Flash	DPM watchdog has expired.
	 (off)	Off	Station is disconnected.
L/A Ch0 & Ch1	LED green		
	 (green)	On	Link: The station is linked to the Ethernet, but does not send/receive Ethernet frames.
	 (green)	Flickering (load dependent)	Activity: The station is linked to the Ethernet and sends/receives Ethernet frames.
	 (off)	Off	The station has no link to the Ethernet.
Ch0 & Ch1	LED yellow		
	 (off)	Off	This LED is not used.

Table 45: LED states for the CC-Link IE Field Basic Slave

LED State	Definition
Triple Flash	The indicator shows a sequence of three short flashes (each 200 ms), separated by a short off phase (200 ms). The sequence is finished by a long off phase (1,000 ms).
Blinking (2.5 Hz)	The indicator turns on and off with a frequency of 2.5 Hz: "on" for 200 ms, followed by "off" for 200 ms.
Flickering (10 Hz)	The indicator turns on and off with a frequency of 10 Hz: "on" for 50 ms, followed by "off" for 50 ms.
Flickering (load dependent)	The indicator turns on and off with a frequency of approximately 10 Hz to indicate high Ethernet activity: on for approximately 50 ms, followed by off for 50 ms. The indicator turns on and off in irregular intervals to indicate low Ethernet activity.

Table 46: LED state definitions for the CC-Link IE Field Basic Slave protocol

7.6 EtherCAT Master

For the EtherCAT Master protocol, the communication LEDs **RUN** and **ERR** as well as the Ethernet LEDs **LINK** and **ACT** can assume the states described below. This description is valid from stack version V4.0.



















LED	Color	State	Meaning
RUN General name: COM 0	Duo LED red/green		
	 (off)	Off	INIT: The device is in state INIT.
	 (green)	Blinking (2,5 Hz)	PRE-OPERATIONAL: The device is in PRE-OPERATIONAL state.
	 (green)	Flickering (10 Hz)	The device is not configured.
	 (green)	Single flash	SAFE-OPERATIONAL: The device is in SAFE-OPERATIONAL state.
	 (green)	On	OPERATIONAL: The device is in OPERATIONAL state.
ERR General name: COM 1	Duo-LED red/green		
	 (off)	Off	Master has no errors.
	 (red)	Single flash	Bus Sync error threshold
	 (red)	Double flash	Internal Stop of the bus cycle
	 (red)	Triple Flash	DPM watchdog has expired.
	 (red)	Quadruple Flash	No Master license present in the device.
	 (red)	Blinking (2,5 Hz)	Error in the configuration database.
	 (red)	Single Flickering	Channel Init was executed at the Master. Remarks: Transient error so can happen to be not visible at all.
	 (red)	Double Flickering	Slave is missing. Unconfigured Slave No matching mandatory slave list No bus connected
	 (red)	Flickering (10 Hz)	Boot-up was stopped due to an error.
LINK Ch0	LED green		
	 (green)	On	Link: The device is linked to the Ethernet, but does not send/receive Ethernet frames.
	 (green)	Flickering (load dependent)	Activity: The device is linked to the Ethernet and sends/receives Ethernet frames.
	 (off)	Off	The device has no link to the Ethernet.
ACT Ch0	LED yellow		
	 (off)	Off	This LED is not used.

Table 47: LED states for the EtherCAT Master protocol

LED State	Definition
Single flash	The indicator shows one short flash (200 ms) followed by a long “off” phase (1,000 ms).
Double flash	The indicator shows a sequence of two short flashes (each 200 ms), separated by a short off phase (200 ms). The sequence is finished by a long off phase (1,000 ms).
Triple Flash	The indicator shows a sequence of three short flashes (each 200 ms), separated by a short off phase (200 ms). The sequence is finished by a long off phase (1,000 ms).

LED State	Definition
Quadruple Flash	The indicator shows a sequence of four short flashes (each 200 ms), separated by a short off phase (200 ms). The sequence is finished by a long off phase (1,000 ms).
Blinking (2,5 Hz)	The indicator turns on and off with a frequency of 2,5 Hz: "on" for 200 ms, followed by "off" for 200 ms.
Single Flickering	The indicator is switched on and off once: 'on' for 50 ms, followed by 'off' for 500 ms.
Double Flickering	The indicator is switched on and off and on once: 'on' / 'off' / 'on' each for approximately 50 ms, followed by 'off' for 500 ms.
Flickering (10 Hz)	The indicator turns on and off with a frequency of 10 Hz: "on" for 50 ms, followed by "off" for 50 ms.
Flickering (load dependant)	The indicator turns on and off with a frequency of approximately 10 Hz to indicate high Ethernet activity: on for approximately 50 ms, followed by off for 50 ms. The indicator turns on and off in irregular intervals to indicate low Ethernet activity.

Table 48: LED state definitions for the EtherCAT Master protocol

7.7 EtherCAT Slave

For the EtherCAT Slave protocol, the communication LEDs **RUN** and **ERR** as well as the Ethernet-LED **L/A IN** or **L/A OUT** can assume the states described below. This description is valid from stack version V2.5 (V2).













LED	Color	State	Meaning
RUN General name: COM 0	Duo LED red/green		
	 (off)	Off	INIT: The device is in state INIT.
	 (green)	Blinking (2,5 Hz)	PRE-OPERATIONAL: The device is in PRE-OPERATIONAL state.
	 (green)	Single flash	SAFE-OPERATIONAL: The device is in SAFE-OPERATIONAL state.
	 (green)	On	OPERATIONAL: The device is in OPERATIONAL state.
ERR General name: COM 1	Duo-LED red/green		
	 (off)	Off	No error: The EtherCAT communication of the device is in working condition.
	 (red)	Blinking (2,5 Hz)	Invalid configuration: General Configuration Error Possible reason: State change commanded by master is impossible due to register or object settings.
	 (red)	Single Flash	Local error: Slave device application has changed the EtherCAT state autonomously. Possible reason 1: A host watchdog timeout has occurred. Possible reason 2: Synchronization Error, device enters Safe-Operational automatically.
	 (red)	Double Flash	Application watchdog timeout: An application watchdog timeout has occurred. Possible reason: Sync Manager Watchdog timeout.
L/A IN or L/A OUT	LED green		
	 (green)	On	Link: The device is linked to the Ethernet, but does not send/receive Ethernet frames.
	 (green)	Flickering (load dependant)	Activity: The device is linked to the Ethernet and sends/receives Ethernet frames.
	 (off)	Off	The device has no link to the Ethernet.
	LED yellow		
	 (off)	Off	This LED is not used.

















Table 49: LED states for the EtherCAT Slave protocol

LED State	Beschreibung
Blinking (2,5 Hz)	The indicator turns on and off with a frequency of 2,5 Hz: "on" for 200 ms, followed by "off" for 200 ms.
Single flash	The indicator shows one short flash (200 ms) followed by a long "off" phase (1,000 ms).
Double flash	The indicator shows a sequence of two short flashes (each 200 ms), separated by a short off phase (200 ms). The sequence is finished by a long off phase (1,000 ms).
Flickering (load dependant)	The indicator turns on and off with a frequency of approximately 10 Hz to indicate high Ethernet activity: on for approximately 50 ms, followed by off for 50 ms. The indicator turns on and off in irregular intervals to indicate low Ethernet activity.

Table 50: LED state definitions for the EtherCAT Slave protocol

7.8 EtherNet/IP Scanner (Master)

For the EtherNet/IP Scanner protocol, the communication LEDs **MS** and **NS** as well as the Ethernet LEDs **LINK** and **ACT** can assume the states described below. This description is valid from stack version V2.6.

LED	Color	State	Meaning
MS (Module status) General name: COM 0	Duo-LED red/green		
	 (green)	On	Device operational: The device is operating correctly.
	 (green)	Flashing (1 Hz)	Standby: The device has not been configured.
	  	Flashing (green/red/green)	Self-test: The device is performing its power-up testing. The module status indicator test sequence occurs before the network status indicator test sequence, according to the following sequence: <ul style="list-style-type: none"> • Network status LED off. • Module status LED turns green for approximately 250 ms, turns red for approximately 250 ms, and again turns green (and holds that state until the power-up test has completed). • Network status LED turns green for approximately 250 ms, turns red for approximately 250 ms, and then turns off (and holds that state until the power-up test has completed).
	 (red)	Blinking (1 Hz)	Major recoverable fault: The device has detected a major recoverable fault. E.g., an incorrect or inconsistent configuration can be considered a major recoverable fault.
	 (red)	On	Major unrecoverable fault: The device has detected a major unrecoverable fault.
	 (Off)	Off	No power: The device is powered off.
NS (Network-status) General name: COM 1	Duo-LED red/green		
	 (green)	On	Connected: An IP address is configured, at least one CIP connection (any transport class) is established, and an Exclusive Owner connection has not timed out.
	 (green)	Flashing (1 Hz)	No connections: An IP address is configured, but no CIP connections are established, and an Exclusive Owner connection has not timed out.
	  	Flashing (green/red/off)	Self-test: The device is performing its power-up testing. Refer to description for module status LED self-test.
	 (red)	Blinking (1 Hz)	Connection timeout: An IP address is configured, and an Exclusive Owner connection for which this device is the target has timed out. The network status indicator returns to steady green only when all timed out Exclusive Owner connections are reestablished.
	 (red)	On	Duplicate IP: The device has detected that its IP address is already in use.
	 (Off)	Off	Not powered, no IP address: The device does not have an IP address (or is powered off).





LED	Color	State	Meaning
LINK Ch0 & Ch1	LED green		
	 (green)	On	The device is linked to the Ethernet.
	 (Off)	Off	The device has no link to the Ethernet.
ACT Ch0 & Ch1	LED yellow		
	 (yellow)	Flickering (load de- pendant)	The device sends/receives Ethernet frames.
	 (Off)	Off	The device does not send/receive Ethernet frames.















Table 51: LED states for the EtherNet/IP Scanner protocol

LED state	Definition
Blinking (1 Hz)	The indicator turns on and off with a frequency of 1 Hz: “on” for 500 ms, followed by “off” for 500 ms.
Flickering (load dependant)	The indicator turns on and off with a frequency of approximately 10 Hz to indicate high Ethernet activity: on for approximately 50 ms, followed by off for 50 ms. The indicator turns on and off in irregular intervals to indicate low Ethernet activity.

Table 52: LED state definitions for the EtherNet/IP Scanner protocol

7.9 EtherNet/IP Adapter (Slave)

For the EtherNet/IP Adapter protocol, the communication LEDs **MS** and **NS** as well as the Ethernet LEDs **LINK** and **ACT** can assume the states described below. This description is valid from stack version V3.4 (V3).

LED	Color	State	Meaning
MS (Module status) General name: COM 0	Duo-LED red/green		
	 (green)	On	Device operational: The device is operating correctly.
	 (green)	Flashing (1 Hz)	Standby: The device has not been configured.
	 (green/red/green)	Flashing fast green/red/green	Self-test: The device performs a self-test after power-on. The following sequence is displayed during the self-test: <ul style="list-style-type: none"> • NS-LED off. • MS-LED turns green for approximately 250 ms, turns red for approximately 250 ms, and again turns green (and holds that state until the power-up test has completed). • NS-LED turns green for approximately 250 ms, turns red for approximately 250 ms, and then turns off (and holds that state until the power-up test has completed).
	 (red/green/off)	Flashing sequence red/green/off	Flashing sequence: The flashing sequence is used to visually identify the device. The scanner can start the flashing sequence in Identity object 1 of the device. The MS LED and NS LED perform the flashing sequence simultaneously.
	 (red)	Flashing (1 Hz)	Major recoverable fault: The device has detected a major recoverable fault. E.g., an incorrect or inconsistent configuration can be considered a major recoverable fault.
	 (red)	On	Major unrecoverable fault: The device has detected a major unrecoverable fault.
	 (off)	Off	No power: The device is powered off.
NS (Network-status) General name:: COM 1	Duo-LED red/green		
	 (green)	On	Connected: An IP address is configured, at least one CIP connection (any transport class) is established, and an Exclusive Owner connection has not timed out.
	 (green)	Flashing (1 Hz)	No connections: An IP address is configured, but no CIP connections are established, and an Exclusive Owner connection has not timed out.
	 (green/red/green)	Flashing fast green/red/green	Self-test: The device performs a self-test after power-on. Refer to the description of the MS LED in the self-test status.
	 (red/green/off)	Flashing sequence red/green/off	Flashing sequence: The flashing sequence is used to visually identify the device. The scanner can start the flashing sequence in Identity object 1 of the device. The MS LED and NS LED perform the flashing sequence simultaneously.
	 (red)	Flashing (1 Hz)	Connection timeout: An IP address is configured, and an Exclusive Owner connection for which this device is the target has timed out. The NS LED returns to steady green only when all timed out Exclusive Owner connections are reestablished.
	 (red)	On	Duplicate IP: The device has detected that its IP address is already in use.
	 (off)	Off	Not powered, no IP address: The device does not have an IP address (or is powered off).





LED	Color	State	Meaning
LINK Ch0 & Ch1	LED grün		
	 (green)	On	The device is linked to the Ethernet.
	 (off)	Off	The device has no link to the Ethernet.
ACT Ch0 & Ch1	LED gelb		
	 (yellow)	Flickering (load de-pendant)	The device sends/receives Ethernet frames.
	 (aus)	Off	The device does not send/receive Ethernet frames.

Table 53: LED states for the EtherNet/IP Adapter protocol

LED state	Definition
Flashing (1 Hz)	The LED turns on and off with a frequency of 1 Hz: "On" for 500 ms, followed by "Off" for 500 ms.
Flashing fast green/red/green	The MS LED or NS LED turns on green "On" for 250 ms, then red "On" for 250 ms, then green "On" (until the test is completed).
Flashing sequence red/green/off	The MS LED and NS LED each turn red "On" for 500 ms, then green "On" for 500 ms, then "Off" for 500 ms. This flashing sequence is repeated at least 6 times.
Flickering (load dependant)	The indicator turns on and off with a frequency of approximately 10 Hz to indicate high Ethernet activity: on for approximately 50 ms, followed by off for 50 ms. The indicator turns on and off in irregular intervals to indicate low Ethernet activity.

Table 54: LED state definitions for the EtherNet/IP Adapter protocol

7.10 Open Modbus/TCP

For the OpenModbusTCP protocol, the communication LEDs **RUN** and **ERR** as well as the Ethernet LEDs **LINK** and **ACT** can assume the states described below. This description is valid from stack version V2.5.











LED	Color	State	Meaning
RUN General name: COM 0	Duo-LED red/green		
	 (green)	On	Connected: OMB task has communication. At least one TCP connection is established.
	 (green)	Flashing (1 Hz)	Ready, not yet configured: OMB task is ready and not yet configured.
	 (green)	Flashing (5 Hz)	Waiting for Communication: OMB task is configured.
	 (off)	Off	Not Ready: OMB task is not ready.
ERR General name: COM 1	Duo-LED red/green		
	 (off)	Off	No communication error
	 (red)	Flashing (2 Hz, 25% on)	System error
	 (red)	On	Communication error active
LINK Ch0 & Ch1	LED green		
	 (green)	On	The device is linked to the Ethernet.
	 (off)	Off	The device has no link to the Ethernet.
ACT Ch0 & Ch1	LED yellow		
	 (yellow)	Flickering (load dependant)	The device sends/receives Ethernet frames.
	 (off)	Off	The device does not send/receive Ethernet frames.

Table 55: LED states for the OpenModbusTCP protocol

LED state	Definition
Flashing (1 Hz)	The indicator turns on and off with a frequency of 1 Hz: "on" for 500 ms, followed by "off" for 500 ms.
Flashing (2 Hz, 25% on)	The indicator turns on and off with a frequency of 2 Hz: "on" for 125 ms, followed by "off" for 375 ms.
Flashing (5 Hz)	The indicator turns on and off with a frequency of 5 Hz: "on" for 100 ms, followed by "off" for 100 ms.
Flickering (load dependant)	The indicator turns on and off with a frequency of approximately 10 Hz to indicate high Ethernet activity: on for approximately 50 ms, followed by off for 50 ms. The indicator turns on and off in irregular intervals to indicate low Ethernet activity.

Table 56: LED state definitions for the OpenModbusTCP protocol

7.11 POWERLINK Controlled Node/Slave

For the POWERLINK Controlled Node protocol, the communication LEDs **BS** (Bus Status) and **BE** (Bus Error) as well as the Ethernet LED **L/A** can assume the states described below. This description is valid from stack version V2.1 respectively from stack version V3.0.













LED	Color	State	Meaning
BS (Bus Status) General name: COM 0	Duo LED red/green		
	 (green)	On	Slave is in ' Operational ' state
	 (green)	Triple Flash	Slave is in ' ReadyToOperate ' state
	 (green)	Double flash	Slave is in ' Pre-Operational 2 ' state
	 (green)	Single flash	Slave is in ' Pre-Operational 1 ' state
	 (green)	Flickering (10 Hz)	Slave is in ' Basic Ethernet ' state
	 (green)	Blinking (2,5 Hz)	Slave is in ' Stopped ' state
	 (off)	Off	Slave initializing
BE (Bus Error) General name: COM 1	Duo LED red/green		
	 (off)	Off	Slave has no error
	 (red)	On	Slave has detected an error
L/A Ch0 & Ch1	LED green		
	 (green)	On	Link: The device is linked to the Ethernet, but does not send/receive Ethernet frames.
	 (green)	Flickering (load dependant)	Activity: The device is linked to the Ethernet and sends/receives Ethernet frames.
	 (off)	Off	The device has no link to the Ethernet.
Ch0 & Ch1	LED yellow		
	 (off)	Off	This LED is not used.

Table 57: LED states for the POWERLINK Controlled Node protocol

LED state	Definition
Triple Flash	The indicator shows a sequence of three short flashes (each 200 ms), separated by a short off phase (200 ms). The sequence is finished by a long off phase (1,000 ms).
Double flash	The indicator shows a sequence of two short flashes (each 200 ms), separated by a short off phase (200 ms). The sequence is finished by a long off phase (1,000 ms).
Single flash	The indicator shows one short flash (200 ms) followed by a long "off" phase (1,000 ms).
Flickering (10 Hz)	The indicator turns on and off with a frequency of 10 Hz: "on" for 50 ms, followed by off for 50 ms. The red LED and the green LED are switched on alternately.
Blinking (2,5 Hz)	The indicator turns on and off phase with a frequency of 2.5 Hz: on for 200 ms, followed by off for 200 ms. The red LED and the green LED are switched on alternately.
Flickering (load dependant)	The indicator turns on and off with a frequency of approximately 10 Hz to indicate high Ethernet activity: on for approximately 50 ms, followed by off for 50 ms. The indicator turns on and off in irregular intervals to indicate low Ethernet activity.

Table 58: LED state definitions for the POWERLINK Controlled Node protocol

7.12 PROFINET IO Controller

For the PROFINET IO Controller protocol, the system status LED **SYS**, the communication LEDs **SF** (system failure) and **BF** (bus failure), as well as the Ethernet LEDs **LINK** and **RX/TX** can assume the states described below. This description is valid from stack version V3.0.







SYS	SF	BF	Meaning
System Status yellow/green	System Failure COM 0 red/green	Bus Failure COM 1 red/green	LED name General LED name Colours of the Duo LEDs SYS, SF or BF
Firmware and Configuration			
● Off	● Off	● Off	Power supply for the device is missing or hardware defect.
● On, yellow	● Off	● Off	No second stage bootloader found in Flash memory.
 Flashing, green/yellow, cyclic	● Off	● Off	No firmware file found in Flash file system.
● On, green	● On, red	● Off	PROFINET IO Controller is not configured.
● On, green	● Off	● On, red	No Ethernet port has a link. E.g., no cable connected to any of the Ethernet ports.
● On, green	● Off	 Flashing, red, 2 Hz	PROFINET IO Controller is not online (Bus is switched to Off).
PROFINET communication			
● On, green	● Off or ● On, red	 Flashing, red, 1 Hz	Not all configured devices are in data exchange.
● On, green	● On, red	-	One IO Device connected to the PROFINET IO Controller reports a problem.
● On, green	● Off	● Off	All devices are in data exchange and no problem has been reported by any device.
PROFINET IO Controller operation			
● On, green	 Flashing, red, 1 Hz, 3 s	● Off	A PROFINET DCP Set Signal has been received.
● On, green	 Flashing, red, 2 Hz	 Flashing, red, 2 Hz	The PROFINET IO Controller has detected an address conflict. Another device in the network is using the same Name of Station or IP address as the PROFINET IO Controller. Or Watchdog error
● On, green	● On, red	● On, red	No valid Master license

Table 59: PROFINET IO Controller, SYS, COM0 and COM1 LEDs states





LED	Color	State	Meaning
LINK Ch0 & Ch1	LED green		
	 (green)	On	The device is linked to the Ethernet.
	 (off)	Off	The device has no link to the Ethernet.
RX/TX Ch0 & Ch1	LED yellow		
	 (gelb)	Flickering (load dependent)	The device sends/receives Ethernet frames.
	 (off)	Off	The device does not send/receive Ethernet frames.

Table 60: PROFINET IO Controller, Ethernet LEDs states

LED state	Definition
Flashing (1 Hz, 3 s)	The indicator turns on and off for 3 seconds with a frequency of 1 Hz: "on" for 500 ms, followed by "off" for 500 ms.
Flashing (1 Hz)	The indicator turns on and off with a frequency of 1 Hz: "on" for 500 ms, followed by "off" for 500 ms.
Flashing (2 Hz)	The indicator turns on and off with a frequency of 2 Hz: "on" for 250 ms, followed by "off" for 250 ms.
Flickering (load dependant)	The indicator turns on and off with a frequency of approximately 10 Hz to indicate high Ethernet activity: on for approximately 50 ms, followed by off for 50 ms. The indicator turns on and off in irregular intervals to indicate low Ethernet activity.

Table 61: PROFINET IO Controller, LEDs states definitions

7.13 PROFINET IO-Device

For the PROFINET IO-Device protocol, the communication LEDs **SF** (System Failure) and **BF** (Bus Failure) as well as the Ethernet LEDs **LINK** and **RX/TX** can assume the states described below. This description is valid from stack version V3.x (V3).











LED	Color	State	Meaning
SF (System Failure) General name: COM 0	Duo LED red/green		
	 (off)	Off	No error
	 (red)	Flashing (1 Hz, 3 s)	DCP signal service is initiated via the bus.
	 (red)	On	Watchdog timeout; channel, generic or extended diagnosis present; system error
BF (Bus Failure) General name: COM 1	Duo LED red/green		
	 (off)	Off	No error
	 (red)	Flashing (2 Hz)	No data exchange
	 (red)	On	No configuration; or low speed physical link; or no physical link
LINK Ch0 & Ch1	LED green		
	 (green)	On	The device is linked to the Ethernet.
	 (off)	Off	The device has no link to the Ethernet.
RX/TX Ch0 & Ch1	LED yellow		
	 (gelb)	Flickering (load dependant)	The device sends/receives Ethernet frames.
	 (off)	Off	The device does not send/receive Ethernet frames.

Table 62: LED states for the PROFINET IO-Device protocol

LED state	Definition
Flashing (1 Hz, 3 s)	The indicator turns on and off for 3 seconds with a frequency of 1 Hz: "on" for 500 ms, followed by "off" for 500 ms.
Flashing (2 Hz)	The indicator turns on and off with a frequency of 2 Hz: "on" for 250 ms, followed by "off" for 250 ms.
Flickering (load dependant)	The indicator turns on and off with a frequency of approximately 10 Hz to indicate high Ethernet activity: on for approximately 50 ms, followed by off for 50 ms. The indicator turns on and off in irregular intervals to indicate low Ethernet activity.

Table 63: LED state definitions for the PROFINET IO-Device protocol

7.14 Sercos Master

For the Sercos Master protocol, the communication LEDs **STA** and **ERR** as well as the Ethernet LED **L/A** can assume the states described below. This description is valid from stack version V2.1.





















LED	Color	State	Meaning
STA General name: COM 0	Duo LED red/green		
	 (green)	On	CP4: Communication phase 4
	 (green)	Triple Flash	CP3: Communication phase 3
	 (green)	Double flash	CP2: Communication phase 2
	 (green)	Single flash	CP1: Communication phase 1
	 (green)	Blinking (2,5 Hz)	CP0: Communication phase 0
	 (green)	Flickering (10 Hz)	Master is not configured and is in NRT. After a status change this isn't indicated again
 (off)	Off	NRT: Non Real-Time Mode	
ERR General name: COM 1	Duo LED red/green		
	 (red)	Single flash	Bus Sync error threshold
	 (red)	Double flash	Internal Stop of the bus cycle
	 (red)	Triple Flash	DPM watchdog has expired.
	 (red)	Quadruple Flash	No Master license present in the device.
	 (red)	Blinking (2,5 Hz)	Error in the configuration database.
	 (red)	Single Flickering	Channel Init was executed at the Master.
	 (red)	Double Flickering	Slave is missing.
	 (red)	Flickering (10 Hz)	Boot-up was stopped due to an error.
 (off)	Off	No error	
L/A Ch0 & Ch1	LED green		
	 (green)	On	Link: The device is linked to the Ethernet, but does not send/receive Ethernet frames.
	 (green)	Flickering (load dependant)	Activity: The device is linked to the Ethernet and sends/receives Ethernet frames.
 (off)	Off	The device has no link to the Ethernet.	
Ch0 & Ch1	LED yellow		
	 (off)	Off	This LED is not used.

Table 64: LED states for the Sercos Master protocol

LED state	Definition
Single flash	The indicator shows one short flash (200 ms) followed by a long "off" phase (1,000 ms).
Double flash	The indicator shows a sequence of two short flashes (each 200 ms), separated by a short off phase (200 ms). The sequence is finished by a long off phase (1,000 ms).
Triple Flash	The indicator shows a sequence of three short flashes (each 200 ms), separated by a short off phase (200 ms). The sequence is finished by a long off phase (1,000 ms).
Quadruple Flash	The indicator shows a sequence of four short flashes (each 200 ms), separated by a short off phase (200 ms). The sequence is finished by a long off phase (1,000 ms).
Blinking (2,5 Hz)	The indicator turns on and off with a frequency of 2,5 Hz: "on" for 200 ms, followed by "off" for 200 ms.
Single Flickering	The indicator is switched on and off once: 'on' for 50 ms, followed by 'off' for 500 ms.
Double Flickering	The indicator is switched on and off and on once: 'on' / 'off' / 'on' each for approximately 50 ms, followed by 'off' for 500 ms.
Flickering (10 Hz)	The indicator turns on and off with a frequency of 10 Hz: 'on' for 50 ms, followed by 'off' for 50 ms.
Flickering (load dependant)	The indicator turns on and off with a frequency of approximately 10 Hz to indicate high Ethernet activity: 'on' for approximately 50 ms, followed by 'off' for 50 ms. The indicator turns on and off in irregular intervals to indicate low Ethernet activity.

Table 65: LED state definitions for the Sercos Master protocol

7.15 Sercos Slave

For the Sercos Slave protocol, the communication LED **S** as well as the Ethernet LED **L/A** can assume the states described below. This description is valid from stack version V3.2.

















LED	Color	State	Meaning
S General name: COM 0	Duo LED red/green (orange = red/green simultaneously)		
	 (green)	On	CP4: Communication phase 4: Normal operation, no error
	 (green)	Blinking (2 Hz)	Loopback: The network state has changed from „fast-forward“ to „loopback“.
	 (green/orange)	Flashing (3 x green/3s)	CP3: Communication phase 3
		(2 x green/3s)	CP2: Communication phase 2
		(1 x green/3s)	CP1: Communication phase 1
	 (orange)	On	CP0: Communication phase 0
	 (orange/green)	Blinking (2 Hz)	HP0: Hot-plug mode
		(1 x orange/3s)	HP1: Hot-plug mode
		(2 x orange/3s)	HP2: Hot-plug mode
	 (orange)	Flashing (2 Hz)	Identification: Invoked by (C-DEV.Bit15 in the Device Control) Or SIP Identification Request
	 (green/red)	Flashing (2 Hz, min. 2s)	MST losses ≥ (S-0-1003/2): The communication warning (S-DEV.Bit 15) is present in the Device Status.
	 (red/orange)	Flashing (2 Hz)	Application error (C1D): See GDP & FSP Status codes class error.
 (red)	Flashing (2 Hz)	Watchdog error: Application is not running	
 (red)	On	Communication Error (C1D): Error detected according to Sercos third generation Class 1 Diagnosis, see SCP Status codes class error.	
 (off)	Off	NRT-Mode: (Non Real-Time Mode) No Sercos Communication	
General name: COM 1	Duo LED red/green		
	 (off)	Off	This LED is not used.
L/A Ch0 & Ch1	LED green		
	 (green)	On	Link: The device is linked to the Ethernet, but does not send/receive Ethernet frames.
	 (green)	Flickering (load dependant)	Activity: The device is linked to the Ethernet and sends/receives Ethernet frames.
	 (off)	Off	The device has no link to the Ethernet.
Ch0 & Ch1	LED yellow		
	 (off)	Off	This LED is not used.

Table 66: LED state definitions for the Sercos Slave protocol

LED state	Definition
Flashing (2 Hz)	The indicator turns on and off with a frequency of 2 Hz: <i>one color:</i> On for appr. 250 ms, followed by off for appr. 250 ms. <i>two colors:</i> First color for appr. 250 ms, followed by the second color for appr. 250 ms.
Flashing (1 x green/3s) (2 x green/3s) (3 x green/3s) (1 x orange/3s) (2 x orange/3s)	Flashing green for 250 ms, then orange on for 2 second and 750 ms. Flashing green / orange / green, each for 250 ms, then orange on for 2 seconds and 250 ms. Flashing green / orange / green / orange / green, each for 250 ms, then orange on for 1 second and 750 ms. Flashing orange for 250 ms, then green on for 2 second an 750 ms. Flashing orange / green / orange, each for 250 ms, then green on for 2 seconds and 250 ms.
Flickering (load dependant)	The indicator turns on and off with a frequency of approximately 10 Hz to indicate high Ethernet activity: "on" for approximately 50 ms, followed by "off" for 50 ms. The indicator turns on and off in irregular intervals to indicate low Ethernet activity.

Table 67: LED state definitions for the Sercos Slave protocol

7.16 VARAN Client (Slave)

For the VARAN Client protocol, the communication LEDs **RUN** and **ERR** as well as the Ethernet LEDs **LINK IN** and **LINK OUT** or **ACT IN** and **ACT OUT** can assume the states described below. This description is valid from stack version V1.0.











LED	Color	State	Meaning
RUN General name: COM 0	Duo-LED red/green		
	 (green)	On	Configured and communication is active.
	 (green)	Blinking (5 Hz)	Configured and communication is inactive.
	 (off)	Off	Not configured.
ERR General name: COM 1	Duo-LED red/green		
	 (off)	Off	Configured.
	 (red)	Blinking (5 Hz)	Not configured.
	 (red)	On	Communication error occurred.
LINK IN Ch0 & LINK OUT Ch1	LED green		
	 (green)	On	The device is linked to the Ethernet.
	 (off)	Off	The device has no link to the Ethernet.
ACT IN Ch0 & ACT OUT Ch1	LED yellow		
	 (yellow)	Flickering (load dependant)	The device sends/receives Ethernet frames.
	 (off)	Off	The device does not send/receive Ethernet frames.

Table 68: LED-Zustände für das VARAN-Client-Protokoll

LED state	Definition
Blinking (5 Hz)	The indicator turns on and off with a frequency of 5 Hz: "on" for 100 ms, followed by "off" for 100 ms.
Flickering (load dependant)	The indicator turns on and off with a frequency of approximately 10 Hz to indicate high Ethernet activity: on for approximately 50 ms, followed by off for 50 ms. The indicator turns on and off in irregular intervals to indicate low Ethernet activity.

Table 69: Definitionen der LED-Zustände für das VARAN-Client-Protokoll

7.17 PROFIBUS DP Master

7.17.1 1 Communication Status LED

For the PROFIBUS DP Master protocol, the communication status LED **COM** can assume the states described below. This description is valid from stack version V2.6.







LED	Color	State	Meaning
cifX with 1 Communication Status LED (current Hardware Revision)			
COM	Duo LED red/green		
	 (green)	On	Communication to all Slaves is established.
	 (green)	Flashing (5 Hz)	PROFIBUS is configured, but bus communication is not yet released from the application.
	 (green)	Flashing acyclic	No configuration or faulty configuration
	 (red)	Flashing (5 Hz)	Communication to at least one Slave is disconnected.
	 (red)	On	Communication to all Slaves is disconnected or another serious error has occurred. Redundant Mode: The active Master was not found.
 (off)	Off	Device is not switched on or network power is missing.	

Table 70: LED states for the PROFIBUS DP Master protocol – 1 Communication Status LED (current Hardware Revision)

LED State	Definition
Flashing (5 Hz)	The indicator turns on and off with a frequency of 5 Hz: "on" for 100 ms, followed by "off" for 100 ms.
Flashing acyclic	The indicator turns on and off in irregular intervals.

Table 71: LED state definitions for the PROFIBUS DP Master protocol

7.17.2 2 Communication Status LEDs

For the PROFIBUS DP Master protocol, the communication status LEDs **STA** and **ERR** can assume the states described below. This description is valid from stack version V2.6.







LED	Color	State	Meaning
cifX with 2 Communication Status LEDs (AIFX-DP is connected or for prior Hardware Revisions)			
STA	LED green		
	 (green)	On	Communication to all Slaves is established.
	 (green)	Flashing (5 Hz)	PROFIBUS is configured, but bus communication is not yet released from the application.
	 (green)	Flashing acyclic	No configuration or faulty configuration
	 (off)	Off	<i>The ERR LED is off:</i> Device is not switched on or network power is missing. <i>The ERR LED is flashing or "on":</i> Refer to description LED red.
ERR	LED red		
	 (red)	Flashing (5 Hz)	Communication to at least one Slave is disconnected.
	 (off)	On	Communication to all Slaves is disconnected or another serious error has occurred. Redundant Mode: The active Master was not found.
	 (off)	Off	No error: There is no error, respectively see description for STA LED.

Table 72: LED states for the PROFIBUS DP Master protocol – 2 Communication Status LEDs (AIFX-DP connected or prior Hardware Revision)

LED State	Definition
Flashing (5 Hz)	The LED turns on and off with a frequency of 5 Hz: "On" for 100 ms, followed by "Ooff" for 100 ms.
Flashing acyclic	TheLED turns on and off in irregular intervals.

Table 73: LED state definitions for the PROFIBUS DP Master protocol

7.18 PROFIBUS DP Slave

7.18.1 1 Communication Status LED

For the PROFIBUS DP Slave protocol, the communication status LED **COM** can assume the states described below. This description is valid from stack version V2.7.







LED	Color	State	Meaning
cifX with 1 Communication Status LED (current Hardware Revision)			
COM	Duo LED red/green		
	 (green)	On	RUN, cyclic communication
	 (green)	Flashing, cyclic (2 Hz)	Master is in CLEAR state.
	 (red)	Flashing, acyclic (1 Hz)	Device is not configured.
	 (red)	Flashing, cyclic (2 Hz)	STOP, no communication, connection error
	 (red)	On	Wrong configuration at PROFIBUS DP Slave.
 (off)	Off	Device is not switched on or power is missing. During firmware download process.	

Table 74: LED states for the PROFIBUS DP Slave protocol – 1 Communication Status LED (current Hardware Revision)

LED State	Definition
Flashing, acyclic (1 Hz)	The indicator turns on and off in irregular intervals, with a frequency of 1 Hz: “on” for 750 ms, followed by “off” for 250 ms.
Flashing, cyclic (2 Hz)	The indicator turns on and off with a frequency of 2 Hz: “on” for 250 ms, followed by “off” for 250 ms.

Table 75: LED state definitions for the PROFIBUS DP Slave protocol

7.18.2 2 Communication Status LEDs

For the PROFIBUS DP Slave protocol, the communication status LEDs **STA** and **ERR** can assume the states described below. This description is valid from stack version V2.7.







LED	Color	State	Meaning
cifX with 2 Communication Status LEDs (AIFX-DP is connected or for prior Hardware Revisions)			
STA	LED green		
	 (green)	On	RUN, cyclic communication
	 (green)	Flashing, cyclic (2 Hz)	Master is in CLEAR state.
	 (off)	Off	<i>LED red is off:</i> Device is not switched on or network power is missing. <i>LED red is flashing or on:</i> Refer to description LED red.
ERR	LED red		
	 (red)	Flashing, acyclic (1 Hz)	Device is not configured.
	 (red)	Flashing, cyclic (2 Hz)	STOP, no communication, connection error
	 (red)	On	Wrong configuration at PROFIBUS DP Slave.
	 (off)	Off	No error: There is no error, respectively see description for STA LED.

Table 76: LED states for the PROFIBUS DP Slave protocol – 2 Communication Status LEDs (AIFX-DP connected or prior Hardware Revision)

LED State	Definition
Flashing, acyclic (1 Hz)	The indicator turns on and off in irregular intervals, with a frequency of 1 Hz: “on” for 750 ms, followed by “off” for 250 ms.
Flashing, cyclic (2 Hz)	The indicator turns on and off with a frequency of 2 Hz: “on” for 250 ms, followed by “off” for 250 ms.

Table 77: LED state definitions for the PROFIBUS DP Slave protocol

7.19 PROFIBUS MPI Device

7.19.1 1 Communication Status LED

For the PROFIBUS MPI protocol, the communication status LED **COM** can assume the states described below. This description is valid from stack version V2.4.





LED	Color	State	Meaning
cifX with 1 Communication Status LED			
COM	Duo LED red/green		
	 (green)	On	Status: The device currently holds the PROFIBUS token and is able to transfer telegrams of data.
	 (green)	Blinking (5 Hz)	Status: The device is configured to be a part of the PROFIBUS ring, but it must share the PROFIBUS token with other PROFIBUS-Master devices present on the PROFIBUS ring.
	 (green)	Blinking (0.5 Hz)	Status: Automatic baudrate detection is running
	 (off)	Off	Status: The device has not been integrated into the PROFIBUS ring, i.e. it has not been configured correctly or has a wrong configuration or has not received the PROFIBUS token.

Table 78: LED states for the PROFIBUS MPI protocol – 1 Communication Status LED

LED State	Definition
Blinking (5 Hz)	The indicator turns on and off with a frequency of appr. 5 Hz: “on” for appr. 100 ms, followed by “off” for appr. 100 ms.
Blinking (0.5 Hz)	The indicator turns on and off with a frequency of appr. 0.5 Hz: “on” for appr. 1000 ms, followed by “off” for appr. 1000 ms.

Table 79: LED state definitions for the PROFIBUS MPI protocol

7.19.2 2 Communication Status LEDs

For the PROFIBUS MPI protocol, the communication status LEDs **STA** and **ERR** can assume the states described below. This description is valid from stack version V2.4.





LED	Color	State	Meaning
cifX with 2 Communication Status LEDs (AIFX-DP is connected)			
STA	LED green		
	 (green)	On	Status: The device currently holds the PROFIBUS token and is able to transfer telegrams of data.
	 (green)	Blinking (5 Hz)	Status: The device is configured to be a part of the PROFIBUS ring, but it must share the PROFIBUS token with other PROFIBUS-Master devices present on the PROFIBUS ring.
	 (green)	Blinking (0.5 Hz)	Status: Automatic baudrate detection is running
	 (off)	Off	Status: The device has not been integrated into the PROFIBUS ring, i.e. it has not been configured correctly or has a wrong configuration or has not received the PROFIBUS token.
ERR	LED red		
	 (off)	Off	This LED is not used.

Table 80: LED states for the PROFIBUS MPI protocol – 2 Communication Status LEDs (AIFX-DP connected)

LED State	Definition
Blinking (5 Hz)	The indicator turns on and off with a frequency of appr. 5 Hz: “on” for appr. 100 ms, followed by “off” for appr. 100 ms.
Blinking (0.5 Hz)	The indicator turns on and off with a frequency of appr. 0.5 Hz: “on” for appr. 1000 ms, followed by “off” for appr. 1000 ms.

Table 81: LED state definitions for the PROFIBUS MPI protocol

7.20 CANopen Master

7.20.1 1 Communication Status LED

For the CANopen Master protocol, the communication status LED **CAN** can assume the states described below. This description is valid from stack version V2.11.







LED	Color	State	Meaning
cifX with 1 Communication Status LED (current Hardware Revision)			
CAN	Duo-LED red/green		
	 (green)	On	OPERATIONAL: The device is in the OPERATIONAL state.
	 (green)	Blinking (2,5 Hz)	PREOPERATIONAL: The device is in the PREOPERATIONAL state.
	 (green)	Single flash	STOPPED: The device is in STOPPED state.
	 (red)	Single flash	Warning Limit reached: At least one of the error counters of the CAN controller has reached or exceeded the warning level (too many error frames).
	 (red)	Double flash	Error Control Event: A guard event (NMT Slave or NMT Master) or a heartbeat event (Heartbeat consumer) has occurred.
	 (red)	On	Bus Off: The CAN controller is in bus OFF state.
 (off)	Off	RESET: The device is executing a reset or the device has no configuration.	

Table 82: LED states for the CANopen Master protocol – 1 Communication Status LED (current Hardware Revision)

LED state	Definition
Blinking (2,5 Hz)	The indicator turns on and off with a frequency of 2,5 Hz: "on" for 200 ms, followed by "off" for 200 ms.
Single flash	The indicator shows one short flash (200 ms) followed by a long "off" phase (1,000 ms).
Double flash	The indicator shows a sequence of two short flashes (each 200 ms), separated by a short "off" phase (200 ms). The sequence is finished by a long "off" phase (1,000 ms).

Table 83: LED state definitions for the CANopen Master protocol

7.20.2 2 Communication Status LEDs

For the CANopen Master protocol, the communication status LEDs **RUN** and **ERR** can assume the states described below. This description is valid from stack version V2.11.









LED	Color	State	Meaning
cifX with 2 Communication Status LEDs (AIFX-CO is connected or for prior Hardware Revisions)			
RUN	LED green		
	 (green)	On	OPERATIONAL: The device is in the OPERATIONAL state.
	 (green)	Blinking (2,5 Hz)	PREOPERATIONAL: The device is in the PREOPERATIONAL state.
	 (green)	Single flash	STOPPED: The device is in STOPPED state.
	 (off)	Off	<i>LED red is off:</i> RESET: The device is executing a reset or the device has no configuration. <i>LED red is flashing or "on":</i> Refer to description LED red.
ERR	LED red		
	 (red)	Single flash	Warning Limit reached: At least one of the error counters of the CAN controller has reached or exceeded the warning level (too many error frames).
	 (red)	Double flash	Error Control Event: A guard event (NMT Slave or NMT Master) or a heartbeat event (Heartbeat consumer) has occurred.
	 (red)	On	Bus Off: The CAN controller is in bus OFF state.
	 (off)	Off	No error: There is no error, respectively see description for RUN LED.

Table 84: LED states for the CANopen Master protocol – 2 Communication Status LEDs (AIFX-CO connected or prior Hardware Revision)

LED state	Definition
Blinking (2,5 Hz)	The indicator turns on and off with a frequency of 2,5 Hz: "on" for 200 ms, followed by "off" for 200 ms.
Single flash	The indicator shows one short flash (200 ms) followed by a long "off" phase (1,000 ms).
Double flash	The indicator shows a sequence of two short flashes (each 200 ms), separated by a short "off" phase (200 ms). The sequence is finished by a long "off" phase (1,000 ms).

Table 85: LED state definitions for the CANopen Master protocol

7.21 CANopen Slave

7.21.1 1 Communication Status LED

For the CANopen Slave protocol, the communication status LED **CAN** can assume the states described below. This description is valid from stack version V3.4.









LED	Color	State	Meaning
cifX with 1 Communication Status LED (current Hardware Revision)			
CAN	Duo LED red/green		
	 (green)	On	OPERATIONAL: The device is in the OPERATIONAL state.
	 (green)	Blinking (2.5 Hz)	PREOPERATIONAL: The device is in the PREOPERATIONAL state.
	 (green)	Single flash	STOPPED: The device is in STOPPED state.
	 (red/green)	Flickering (10 Hz)	Auto Baud Rate Detection active: The Device is in the auto baud rate detection mode.
	 (red)	Single flash	Warning Limit reached: At least one of the error counters of the CAN controller has reached or exceeded the warning level (too many error frames).
	 (red)	Double flash	Error Control Event: A guard event (NMT Slave or NMT Master) or a heartbeat event (Heartbeat consumer) has occurred.
	 (red)	On	Bus Off: The CAN controller is in bus OFF state.
 (off)	Off	RESET: The device is executing a reset or the device has no configuration.	

Table 86: States of the CAN LED for the CANopen Slave protocol – 1 Communication Status LED (current Hardware Revision)

LED State	Definition
Flickering (10 Hz)	The indicator turns on and off with a frequency of 10 Hz: “on” for 50 ms, followed by “off” for 50 ms.
Blinking (2.5 Hz)	The indicator turns on and off with a frequency of 2,5 Hz: “on” for 200 ms, followed by “off” for 200 ms.
Single Flash	The indicator shows one short flash (200 ms) followed by a long “off” phase (1,000 ms).
Double Flash	The indicator shows a sequence of two short flashes (each 200 ms), separated by a short off phase (200 ms). The sequence is finished by a long “off” phase (1,000 ms).

Table 87: LED state definitions for the CANopen Slave protocol

7.21.2 2 Communication Status LEDs

For the CANopen Slave protocol, the communication status LEDs **RUN** and **ERR** can assume the states described below. This description is valid from stack version V3.4.











LED	Color	State	Meaning
cifX with 2 Communication Status LEDs (AIFX-CO is connected or for prior Hardware Revisions)			
RUN	LED green		
	 (green)	On	OPERATIONAL: The device is in the OPERATIONAL state.
	 (green)	Blinking (2.5 Hz)	PREOPERATIONAL: The device is in the PREOPERATIONAL state.
	 (green)	Single flash	STOPPED: The device is in STOPPED state.
	 (green)	Flickering (10 Hz, alternatively with ERR LED)	Auto Baud Rate Detection active: The Device is in the auto baud rate detection mode.
	 (off)	Off	<i>LED red is off:</i> RESET: The device is executing a reset or the device has no configuration. <i>LED red is flickering, flashes or "on":</i> Refer to description LED red.
ERR	LED red		
	 (red)	Flickering (10 Hz, alternatively with RUN LED)	Auto Baud Rate Detection active: The Device is in the auto baud rate detection mode.
	 (red)	Single flash	Warning Limit reached: At least one of the error counters of the CAN controller has reached or exceeded the warning level (too many error frames).
	 (red)	Double flash	Error Control Event: A guard event (NMT Slave or NMT Master) or a heartbeat event (Heartbeat consumer) has occurred.
	 (red)	On	Bus Off: The CAN controller is in bus OFF state.
	 (off)	Off	No error: There is no error, respectively see description for RUN LED.

Table 88: States of the CAN LED for the CANopen Slave protocol – 2 Communication Status LEDs (AIFX-CO connected or prior Hardware Revision)

LED State	Definition
Flickering (10 Hz)	The indicator turns on and off with a frequency of 10 Hz: "on" for 50 ms, followed by "off" for 50 ms.
Blinking (2.5 Hz)	The indicator turns on and off with a frequency of 2,5 Hz: "on" for 200 ms, followed by "off" for 200 ms.
Single Flash	The indicator shows one short flash (200 ms) followed by a long "off" phase (1,000 ms).
Double Flash	The indicator shows a sequence of two short flashes (each 200 ms), separated by a short off phase (200 ms). The sequence is finished by a long "off" phase (1,000 ms).

Table 89: LED state definitions for the CANopen Slave protocol

7.22 DeviceNet Master

For the DeviceNet Master protocol, the communication status LED **MNS** can assume the states described below. This description is valid from stack version V2.3.







LED	Color	State	Meaning
MNS	Duo LED red/green		
	 (green)	On	Device operational AND on-line, connected Device is online and has established all connections with all Slaves.
	 (green)	Flashing (1 Hz)	Device operational AND on-line Device is online and has established no connection in the established state. - Configuration missing, incomplete or incorrect.
	 (green/red/Off)	Flashing (2Hz) Green/Red/Off	Self test after power on
	 (red)	Flashing (1 Hz)	Minor fault and/or connection time-out Device is online and has established one or more connections in the established state. It has data exchange with at least one of the configured Slaves. Minor or recoverable fault: No data exchange with one of the configured Slaves. One or more Slaves are not connected. Connection timeout Minor or recoverable fault: No data exchange with one of the configured Slaves. One or more Slaves are not connected. Connection timeout. No network power present.
	 (red)	On	Critical fault or critical link failure Critical connection failure; device has detected a network error: duplicate MAC-ID or severe error in CAN network (CAN-bus off).
 (off)	Off	Device is not powered - The device may not be powered. Device is not on-line and/or no network power - The device has not yet completed the Dup_MAC_ID test. - The device is powered, but the network power is missing.	

Table 90: LED states for the DeviceNet Master protocol

LED state	Definition
Flashing (1 Hz)	The indicator turns on and off with a frequency of appr. 1 Hz: on for appr. 500 ms, followed by off for appr. 500 ms.
Flashing (2 Hz) green/red/off	The indicator turns on green on for 250 ms, then red on for 250 ms, then off.

Table 91: LED state definitions for the DeviceNet Master protocol

7.23 DeviceNet Slave

For the DeviceNet Slave protocol, the communication status LED **MNS** can assume the states described below. This description is valid from stack version V2.3.







LED	Color	State	Meaning
MNS	Duo LED red/green		
	 (green)	On	Device operational AND on-line, connected Device is online and has established all connections with all Slaves.
	 (green)	Flashing (1 Hz)	Device operational AND on-line Device is online and has established no connection in the established state. - Configuration missing, incomplete or incorrect.
	 (green/red/Off)	Flashing (2Hz) Green/Red/Off	Self test after power on
	 (red)	Flashing (1 Hz)	Minor fault and/or connection time-out Device has no connectin to the Master. Minor or recoverable fault: No data exchange with the Master. Connection timeout. No network power present.
	 (red)	On	Critical fault or critical link failure Critical connection failure; device has detected a network error: duplicate MAC-ID or severe error in CAN network (CAN-bus off).
 (off)	Off	Device is not powered - The device may not be powered. Device is not on-line and/or no network power - The device has not yet completed the Dup_MAC_ID test. - The device is powered, but the network power is missing.	

Table 92: LED states for the DeviceNet Slave protocol

LED state	Definition
Flashing (1 Hz)	The indicator turns on and off with a frequency of appr. 1 Hz: on for appr. 500 ms, followed by off for appr. 500 ms.
Flashing (2 Hz) green/red/off	The indicator turns on green on for 250 ms, then red on for 250 ms, then off.

Table 93: LED state definitions for the DeviceNet Slave protocol

7.24 CC-Link Slave

For the CC-Link Slave protocol, the communication status LEDs **L-RUN** and **L-ERR** can assume the states described below. This description is valid from stack version V2.9.





LED	Color	State	Meaning
L RUN	LED green		
	 (green)	On	After participating in the network, the device receives both refresh and polling signals or just the refresh signal normally.
	 (off)	Off	<ol style="list-style-type: none"> 1. Before participating in the network 2. Unable to detect carrier 3. Timeout 4. Resetting hardware
L ERR	LED red		
	 (red)	Blinking	The switch setting has been changed from the setting at the reset cancellation (blinks for 0.4 sec.).
	 (red)	On	<ol style="list-style-type: none"> 1. CRC error 2. Address parameter error (0,65 or greater is set including the number of occupied stations) 3. Baud rate switch setting error during cancellation of reset (5 or greater)
	 (off)	Off	<ol style="list-style-type: none"> 1. Normal communication 2. Resetting hardware

Table 94: LED states for the CC-Link Slave protocol

8 Device Connections and Switches

8.1 Ethernet Interface

RJ45 plugs or M12 plugs are used for the Ethernet interface.

- For RJ45 connector, use twisted pair cable of category 5 (CAT5) or higher, which consists of 4 wires twisted in pairs and has a maximum transmission rate of 100 MBit/s (CAT5).
- For M12 connector, use Category 5 (CAT5) or higher cable with a maximum transfer rate of 100 MBit/s (CAT5).

8.1.1 Ethernet Pin Assignment at the RJ45 Socket



Note: The device supports the **Auto Crossover** function. Due to this fact RX and TX can be switched. The following figure shows the RJ45 standard pin assignment.

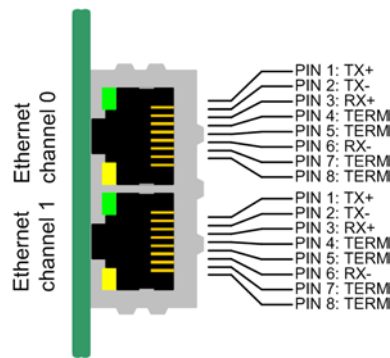

Figure 63: Ethernet Pin Assignment at the RJ45 Socket for cifX or AIFX

Pin	Signal	Meaning
1	TX+	Transmit Data +
2	TX-	Transmit Data -
3	RX+	Receive Data +
4	Term 1	Connected to each other and terminated to PE through RC circuit*
5	Term 1	
6	RX-	Receive Data -
7	Term 2	Connected to each other and terminated to PE through RC circuit*
8	Term 2	
		* Bob Smith Termination

Table 95: Ethernet Pin Assignment at the RJ45 Socket for cifX or AIFX



Note: The RJ45 socket is only for use in LAN, not for telecommunication circuits.

8.1.2 Ethernet Pin Assignment at the M12 Socket

Real-Time Ethernet 2 x M12 plug connections (to DIN EN 61076 2 101/ IEC 61076 2 101), D-coded socket.



Note: The device supports the **Auto Crossover** function. Due to this fact RX and TX can be switched. The following figure shows the M12 standard pin assignment.

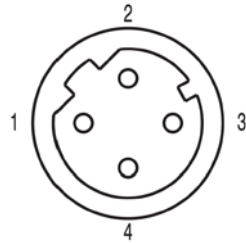

Figure 64: Ethernet Pin Assignment at M12 Socket for AIFX-REW12 (D coded)

Pin	Signal	Meaning
1	TX+	Transmit Data +
2	RX+	Receive Data +
3	TX-	Transmit Data -
4	RX-	Receive Data -
	PE	Metal screw connection

Table 96: Ethernet Pin Assignment M12 Socket for AIFX-REW12

8.1.3 Ethernet Connection Data

Medium	RJ45	2 x 2 Twisted-Pair copper cable, CAT5 (100 MBit/s)
	M12	2 x cable, CAT5 (100 MBit/s)
Length of cable	max. 100 m	
Transmission rate	10 MBit/s/100 MBit/s	

Table 97: Ethernet Connection Data

8.1.4 Use of Hubs and Switches

For the corresponding communication systems, the use of hubs and/or switches is either forbidden or allowed. The following table shows the acceptable use of hubs and switches by each communication system:

Communication System	Hub	Switch
CC-Link IE Field-Basic-Slave	forbidden	star topology, with Layer 2 switch (must support 100 MBit/s, 1 GBit/s support is optional)
EtherCAT	forbidden	only allowed between EtherCAT Master and first EtherCAT Slave (100 MBit/s, Full Duplex)
EtherNet/IP	allowed	allowed (10 MBit/s/100 MBit/s, Full or Half Duplex, Auto-Negotiation)
Open Modbus/TCP	allowed	allowed (10 MBit/s/100 MBit/s, Full or Half Duplex, Auto-Negotiation)
POWERLINK	allowed	forbidden
PROFINET IO	forbidden	Only allowed if the switch supports 'Priority Tagging' and LLDP (100 MBit/s, Full Duplex)
Sercos	forbidden	forbidden
VARAN*	forbidden	forbidden

Table 98: Use of Hubs and Switches

*Instead of hubs and switches VARAN uses splitter. [3]

8.2 PROFIBUS Interface

Isolated RS-485 interface:

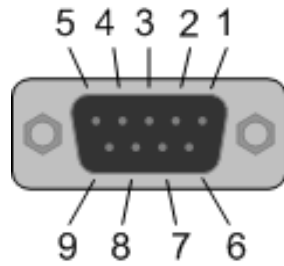

Figure 65: PROFIBUS Interface (DSub female connector, 9 pin), X400

Connection with DSub female connector	Signal	Meaning
3	RxD/TxD-P	Receive/Send Data-P respectively connection B plug
5	DGND	Reference potential
6	VP	Positive supply voltage
8	RxD/TxD-N	Receive/Send Data-N respectively connection A plug

Table 99: PROFIBUS Interface, X400

8.3 CANopen Interface

Isolated ISO 11898 interface:

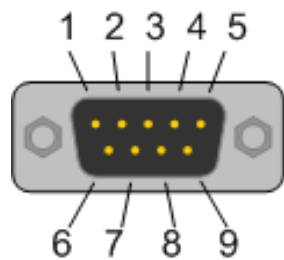

Figure 66: CANopen Interface (DSub male connector, 9 pin), X400

Connection with DSub male connector	Signal	Description
2	CAN_L	CAN_Low Bus Line
3	CAN_GND	CAN Ground
7	CAN_H	CAN High Bus Line
1, 4, 5, 6, 8, 9		Do not connect!

Table 100: CANopen Interface, X400

8.4 DeviceNet Interface

Isolated ISO 11898 interface:

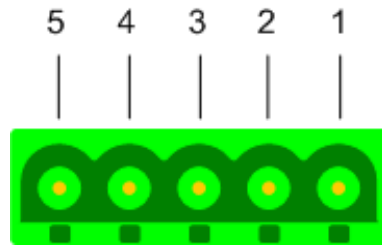

Figure 67: DeviceNet Interface (CombiCon male Connector, 5 pin), X360

Connection with CombiCon male connector	Signal	Color	Description
1	V-	Black	Reference potential DeviceNet supply voltage
2	CAN_L	Blue	CAN Low-Signal
3	Drain		Shield
4	CAN_H	White	CAN High-Signal
5	V+	Red	+24 V DeviceNet supply voltage

Table 101: DeviceNet Interface, X360

8.5 CC-Link Interface

Isolated RS-485 interface:

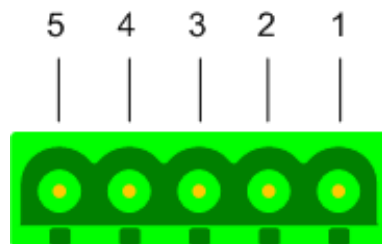

Figure 68: CC-Link Interface (CombiCon male Connector, 5 pin)

Connection with Screw terminal Connector	Signal	Meaning
1	DA	Data A
2	DB	Data B
3	DG	Data Ground
4	SLD	Shield
5	FG	Field Ground

Table 102: CC-Link Interface

8.6 Mini-B USB Connector (5 Pin)

The Mini-B USB connector is provided for the following PC cards cifX: CIFX 80-RE, CIFX 80-DP, CIFX 80-CO, CIFX 80-DN, CIFX 104C-RE, CIFX 104C-DP, CIFX 104C-CO, CIFX 104C-DN, CIFX 104C-RE-R, CIFX 104C-DP-R, CIFX 104C-CO-R, CIFX 104C-DN-R

In addition a Mini-B USB connector will be available for the following PC cards cifX if the AIFX-DIAG is connected to the PC card cifX: CIFX 104C-RE\F* (or CIFX 104C-RE\FM12), CIFX 104C-DP\F, CIFX 104C-CO\F, CIFX 104C-DN\F, CIFX 104C-CC\F, CIFX 104C-RE-R\F*(or CIFX 104C-RE-R\FM12), CIFX 104C-DP-R\F, CIFX 104C-CO-R\F, CIFX 104C-DN-R\F



Note! *From the hardware revision 5 of the PC cards CIFX 104C-RE\F (or CIFX 104C-RE\FM12) and CIFX 104C-RE-R\F (or CIFX 104C-RE-R\FM12),if the diagnostic **AIFX-DIAG** detached network interface is connected, the **Mini-B USB** connector on the AIFX-DIAG can be used.

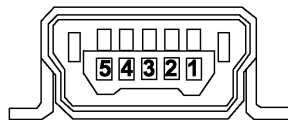

Figure 69: Mini-B USB Connector (5 Pin)

Pin	Name	Description
1	USB_EXT	USB Bus Power (+5 V dc, supplied externally)
2	D-	Data -
3	D+	Data +
4	ID	Not connected
5	GND	Ground

Table 103: Pin Assignment Mini-B USB Connector

8.7 Rotary Switch for PCI-104 Slot Number

Only for CIFX 104C cards.

The **Rotary Switch for PCI-104 Slot Number** is used for setting the physical PCI-104 Slot Number. At maximum four CIFX 104C cards can be plugged as modules one upon the other and each switch position must be used only once. The module plugged next to the host controller gets the CLK number 0, the following modules respectively get the next higher CLK number.

Switch Position	Module No. PCI-104 Slot	CLK No. (Clock)	ID-Select	INT
0, 4, 8	1	CLK 0	IDSEL 0	INTA
1, 5, 9	2	CLK 1	IDSEL 1	INTB
2, 6	3	CLK 2	IDSEL 2	INTC
3, 7	4	CLK 3	IDSEL 3	INTD

Table 104: Rotary Switch for PCI-104 Slot Number, S1

8.8 Rotary Switch Device Address

The **Rotary Switch Device Address** at the PC cards

CIFX 104C-RE, CIFX 104C-RE-R, CIFX 104C-RE\F, CIFX 104C-RE-R\F;

CIFX 104C-RE\F\M12, CIFX 104C-RE-R\F\M12;

CIFX 104C-DP, CIFX 104C-DP-R, CIFX 104C-DP\F, CIFX 104C-DP-R\F,

CIFX 104C-CO, CIFX 104C-CO-R, CIFX 104C-CO\F, CIFX 104C-CO-R\F,

CIFX 104C-DN, CIFX 104C-DN-R, CIFX 104C-DN\F, CIFX 104C-DN-R\F,

CIFX 104-CC/F

currently is unassigned. The Slave address setting is done via the configuration software.

8.9 Cable Connector

8.9.1 Pin Assignment Cable Connector Ethernet X4 or X304

Only for
CIFX 90-RE\F, CIFX 90-RE\F\M12: (X4)

CIFX 90E-RE\F, CIFX 90E-RE\F\M12, CIFX 90E-RE\NHS\F, CIFX 90E-RE\NHS\F\M12, CIFX 90E-RE\ET\F, CIFX 90E-RE\ET\F\M12, CIFX 90E-RE\MR\F, CIFX 90E-RE\MR\F\M12, CIFX 90E-RE\MR\ET\F, CIFX 90E-RE\MR\ET\F\M12: (X4)

CIFX 104C-RE\F, CIFX 104C-RE\F\M12: (X304),
CIFX 104C-RE-R\F, CIFX 104C-RE-R\F\M12: (X4)

Pin Assignment for Cable Connector Ethernet X4 or X304 - Cable 20 pin Ethernet and Status LEDs:

Pin	Signal	Pin	Signal
1	GND	11	CH0_TXP
2	+3V3 Analog	12	CH0_TXN
3	STA0_green (RE LED COM0)	13	CH0_RXP
4	STA0_red (RE LED COM0)	14	CH0_RXN
5	XM0_TX (for M12 variants not assigned)	15	CH1_TXP
6	STA1_green (RE LED COM1)	16	CH1_TXN
7	CH0_LINK (EN LED GRN0)	17	CH1_RXP
8	CH0_ACTIVITY (EN LED YEL0)	18	CH1_RXN
9	/RSTOUT	19	CH1_LINK (EN LED GRN1)
10	STA1_red (RE LED COM1)	20	CH1_ACTIVITY (EN LED YEL1)

Table 105: Pin Assignment for Cable Connector Ethernet X4 or X304

Cable Connector Ethernet X4 or X304:

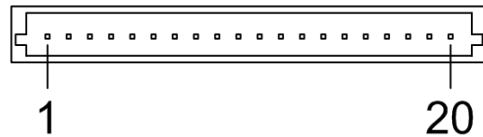

Figure 70: Cable Connector Ethernet X4 or X304; 1x20 Pins for CIFX 104C-RE\F, CIFX 104C-RE\F\M12, CIFX 104C-RE-R\F, CIFX 104C-RE-R\F\M12, CIFX 90-RE\F, CIFX 90-RE\F\M12

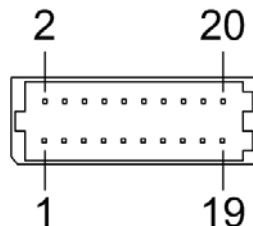

Figure 71: Cable Connector Ethernet X4; 2x10 Pins for CIFX 90E-RE\F, CIFX 90E-RE\F\M12, CIFX 90E-RE\NHS\F, CIFX 90E-RE\NHS\F\M12, CIFX 90E-RE\ET\F, CIFX 90E-RE\ET\F\M12, CIFX 90E-RE\MR\F, CIFX 90E-RE\MR\F\M12 bzw. CIFX 90E-RE\MR\ET\F, CIFX 90E-RE\MR\ET\F\M12

8.9.2 Pin Assignment Cable Connector Fieldbus X3, X304, X4

Only for

CIFX 90-DP\F, CIFX 90-CO\F, CIFX 90-DN\F, CIFX 90-CC\F: (X3) and

CIFX 90E-DP\F, CIFX 90E-CO\F, CIFX 90E-DN\F, ,
 CIFX 90E-DP\NHS\F, CIFX 90E-CO\NHS\F, CIFX 90E-DN\NHS\F, CIFX 90E-CC\NHS\F,
 CIFX 90E-DP\ET\F, CIFX 90E-CO\ET\F, CIFX 90E-DN\ET\F, CIFX 90E-CC\ET\F,
 CIFX 90E-DP\MR\F, CIFX 90E-CO\MR\F, CIFX 90E-DN\MR\F,
 CIFX 90E-DP\MR\ET\F, CIFX 90E-CO\MR\ET\F, CIFX 90E-DN\MR\ET\F
 CIFX 90E-CC\MR\ET\F: (X3)

CIFX 104C-DP\F, CIFX 104C-CO\F, CIFX 104C-DN\F,
 CIFX 104C-CC\F: (X304)

CIFX 104C-DP-R\F, CIFX 104C-CO-R\F, CIFX 104C-DN-R\F: (X4).

Pin Assignment for cable connector fieldbus X3, X304 or X4,
 Cable 10 pin Fieldbus:

Pin	Signal
1	GND
2	+3V3 Analog
3	I2C_CLK/PIO 4
4	I2C_DATA/ PIO 5
5	XMAC2_TX
6	XMAC2_RX
7	XMAC2_IO0
8	XMAC2_IO1
9	/RSTOUT
10	(not used)

Table 106: Pin Assignment for Cable Connector Fieldbus X3, X304 or X4

8.9.3 Pin Assignment Cable Connector Fieldbus X3 and X4 for 2 Channel Devices

Only for

CIFX 90E-2DP\ET\F, CIFX 90E-2DP\MR\ET\F
 CIFX 90E-2DP\CO\ET\F, CIFX 90E-2DP\CO\MR\ET\F
 CIFX 90E-2DP\DN\ET\F, CIFX 90E-2DP\DN\MR\ET\F
 CIFX 90E-2CO\ET\F, CIFX 90E-2CO\MR\ET\F
 CIFX 90E-2CO\DN\ET\F, CIFX 90E-2CO\DN\MR\ET\F
 CIFX 90E-2DN\ET\F, CIFX 90E-2DN\MR\ET\F (X3 and X4)

Pin Assignment for cable connector fieldbus X3 and X4 for 2 channel devices, cable 10 pin fieldbus:

Cable Connector Fieldbus X3		Cable Connector Fieldbus X4	
Pin	Signal	Pin	Signal
1	GND	1	GND
2	+3V3 Analog	2	+3V3 Analog
3	I2C_CLK/PIO 4	3	I2C_CLK/PIO 6
4	I2C_DATA/ PIO 5	4	I2C_DATA/ PIO 7
5	XMAC2_TX	5	XMAC3_TX
6	XMAC2_RX	6	XMAC3_RX
7	XMAC2_IO0	7	XMAC3_IO0
8	XMAC2_IO1	8	XMAC3_IO1
9	/RSTOUT	9	/RSTOUT
10	(not used)	10	(not used)

Table 107: Pin Assignment for Cable Connector Fieldbus X3 and X4 for 2 Channel Devices

8.9.4 Pin Assignment Cable Connector DIAG

Only for

CIFX 104C-RE\F, CIFX 104C-RE\F\M12: (X303),

CIFX 104C-RE-R\F, CIFX 104C-RE-R\F\M12: (X3),

CIFX 104C-DP\F, CIFX 104C-CO\F, CIFX 104C-DN\F,

CIFX 104C-CC\F: (X303)

Pin Assignment for Cable connector DIAG X3 or X303 -
Cable 12 pin USB + Status LEDs

Pin	Signal (Feldbus)	Signal (Ethernet)
1	GND	GND
2	+3V3	+3V3
3	STA2 (FB LED COM 0)	STA2 (not used)
4	STA3 (FB LED COM 1)	STA3 (not used)
5	USB_POS	USB_POS
6	USB_NEG	USB_NEG
7	RDYn	RDYn
8	RUNn	RUNn
9	STA0_green (not used)	STA0_green (RE LED COM 0)
10	STA0_red (not used)	STA0_red (RE LED COM 0)
11	STA1_green (not used)	STA1_green (RE LED COM 1)
12	STA1_red (not used)	STA1_red (RE LED COM 1)

Table 108: Pin Assignment for Cable connector DIAG X3 or X303

8.9.5 Pin Assignment Cable Connector Ethernet X1, AIFX-RE

Only for AIFX-RE; Pin Assignment for Cable Connector Ethernet X1 - Cable 20 pin Ethernet and Status LEDs

Pin	Name	Description	Type
1	GND	Ground	Power
2	3V3	3.3V Power	Power
3	LED COM0-GREEN	LED COM0 (green)	Input
4	LED COM0-RED	LED COM0 (red)	Input
5	-	(not used)	NC
6	LED COM1-GREEN	LED COM1 (green)	Input
7	LED LINK0	LED LINK0 (yellow)	Input
8	LED ACT0	LED ACT0 (green)	Input
9	RSTOUT#	Reset out	Input
10	LED COM1-RED	LED COM01 (red)	Input
11	CH0_TXP	Channel 0 TX+	Input
12	CH0_TXN	Channel 0 TX-	Input
13	CH0_RXP	Channel 0 RX+	Output
14	CH0_RXN	Channel 0 RX-	Output
15	CH1_TXP	Channel 1 TX+	Input
16	CH1_TXN	Channel 1 TX-	Input
17	CH1_RXP	Channel 1 RX+	Output
18	CH1_RXN	Channel 1 RX-	Output
19	LED LINK1	LED LINK1 (yellow)	Input
20	LED ACT1	LED ACT1 (green)	Input

Table 109: Pin Assignment for Cable Connector Ethernet X1, AIFX-RE (Hardware-Rev. 2)

Cable Connector Ethernet X1:

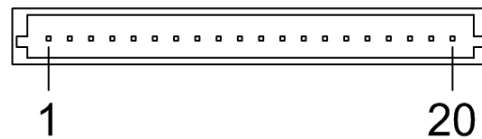

Figure 72: Cable Connector Ethernet X1; 1x20 Pins, AIFX-RE

8.9.6 Pin Assignment Cable Connector Ethernet X2, AIFX-REM12

Only for AIFX-REM12; Pin Assignment for Cable Connector Ethernet X2 - Cable 20 pin Ethernet and Status LEDs

Pin	Signal	Pin	Signal
1	CH1_ACTIVITY (EN LED YEL1)	11	STA1_red (RE LED COM1)
2	CH1_LINK (EN LED GRN1)	12	/RSTOUT
3	CH1_RXN	13	CH0_ACTIVITY (EN LED YEL0)
4	CH1_RXP	14	CH0_LINK (EN LED GRN0)
5	CH1_TXN	15	STA1_green (RE LED COM1)
6	CH1_TXP	16	(unbelegt)
7	CH0_RXN	17	STA0_red (RE LED COM0)
8	CH0_RXP	18	STA0_green (RE LED COM0)
9	CH0_TXN	19	+3V3 Analog
10	CH0_TXP	20	GND

Table 110: Pin Assignment for Cable Connector Ethernet X2, AIFX-REM12

Cable Connector Ethernet X2:

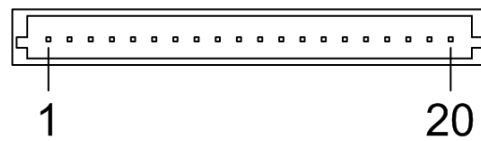

Figure 73: Cable Connector Ethernet X2; 1x20 Pins, AIFX-REM12

8.9.7 Pin Assignment Cable Connector LED Signals X3, AIFX-RE\12

Only for AIFX-RE\12; Pin Assignment for Cable Connector LED Signals X3 - Cable 10 pin Ethernet and Status LEDs

Pin	Signal
1	CH0_LINK_E (EN LED GRN0)
2	CH0_ACTIVITY_E (EN LED YEL0)
3	CH1_LINK_E (EN LED GRN1)
4	CH1_ACTIVITY_E (EN LED YEL1)
5	STA0_green (RE LED COM0)
6	STA0_red (RE LED COM0)
7	STA1_green (RE LED COM1)
8	STA1_red (RE LED COM1)
9	GND
10	

Table 111: Pin Assignment for Cable Connector LED Signals X3, AIFX-RE\12

Cable Connector LED Signals X3:

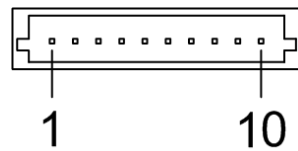

Figure 74: Cable Connector LED Signals X3; 1x10 Pins, AIFX-RE\12



Note: The outputs on the cable connector LED signals X3 can drive max. 5 mA. This means that the maximum permissible current per external LED is 5 mA. If this maximum current is not sufficient, an external driver is required previous to the LED.

8.9.8 Pin Assignment Cable Connector Fieldbus X1, AIFX-DP

Pin assignment for cable connector fieldbus X1, AIFX-DP, 10-pin cable

Pin	Name	Description	Type
1	GND	Ground	Power
2	3V3	3,3V Power	Power
3	I2C_SCL	I2C clock signal	Input
4	I2C_SDA	I2C data signal	Input / Output
5	TX	Fieldbus transmit	Input
6	RX	Fieldbus receive	Output
7	EN_PB	Enable PROFIBUS	Input / Output
8	-	(not used)	NC
9	RSTOUT#	Reset out	Input
10	-	(not used)	NC

Table 112: Pin Assignment for Cable Connector fieldbus X1, AIFX-DP (Hardware Rev. 2)

8.9.9 Pin Assignment Cable Connector Fieldbus X1, AIFX-CO

Pin assignment for cable connector fieldbus X1, AIFX-CO, 10-pin cable

Pin	Name	Description	Type
1	GND	Ground	Power
2	3V3	3,3V Power	Power
3	I2C_SCL	I2C clock signal	Input
4	I2C_SDA	I2C data signal	Input / Output
5	TX	Fieldbus transmit	Input
6	RX	Fieldbus receive	Output
7	-	(not used)	NC
8	-	(not used)	NC
9	RSTOUT#	Reset out	Input
10	-	(not used)	NC

Table 113: Pin Assignment for Cable Connector fieldbus X1, AIFX-CO (Hardware Rev. 2)

8.9.10 Pin Assignment Cable Connector Fieldbus X1, AIFX-DN

Pin assignment for cable connector fieldbus X1, AIFX-DN, 10-pin cable

Pin	Name	Description	Type
1	GND	Ground	Power
2	3V3	3,3V Power	Power
3	I2C_SCL	I2C clock signal	Input
4	I2C_SDA	I2C data signal	Input / Output
5	TX	Fieldbus transmit	Input
6	RX	Fieldbus receive	Output
7	PF_DN	Power fail DeviceNet	Input / Output
8	-	(not used)	NC
9	RSTOUT#	Reset out	Input
10	-	(not used)	NC

Table 114: Pin Assignment for Cable Connector fieldbus X1, AIFX-DN (Hardware Rev. 3)

8.9.11 Pin Assignment Cable Connector Fieldbus X1, AIFX-CC

Pin assignment for cable connector fieldbus X1, AIFX-CC, 10-pin cable

Pin	Name	Description	Type
1	GND	Ground	Power
2	3V3	3,3V Power	Power
3	I2C_SCL	I2C clock signal	Input
4	I2C_SDA	I2C data signal	Input / Output
5	TX	Fieldbus transmit	Input
6	RX	Fieldbus receive	Output
7	EN_CC	Enable CC-Link	Input / Output
8	-	(not used)	NC
9	RSTOUT#	Reset out	Input
10	-	(not used)	NC

Table 115: Pin Assignment for Cable Connector fieldbus X1, AIFX-CC (Hardware Rev. 2)

8.10 Cable for detached Network Interfaces AIFX

8.10.1 Cable for AIFX-RE or AIFX-RE\M12



Note: If the detached network interfaces Ethernet (AIFX-RE) or Ethernet M12 (AIFX-RE\M12) are ordered without a basic card, the connecting cable must be ordered separately.

Cable ⁶ for AIFX	Part No	Note
CAB-AIFX-RE	4.100.102	Connection to cable connector Ethernet with 1 x 20 pins, cable length = 15 cm
CAB-AIFX-RE-15-2	4.100.103	Connection to cable connector Ethernet with 2 x 10 pins, cable length = 15 cm (only for CIFX 90E variants)
CAB-AIFX-RE-20-2	4.100.105	Connection to cable connector Ethernet with 2 x 10 pins, cable length = 20 cm (only for CIFX 90E variants)

Table 116: Cable for connecting the detached Network Interfaces AIFX-RE or AIFX-RE\M12

8.10.2 Optional Cable Length 20 cm for CIFX 90E variants with AIFX-RE or AIFX-RE\M12

For the connection of the detached network interfaces Ethernet (AIFX-RE) or Ethernet M12 (AIFX-RE\M12) for the PC cards cifX with the label "F" in the device name, cables with a length of 15 cm are supplied as standard.

The PC cards CIFX 90E variants Real-Time Ethernet (with AIFX-RE or AIFX-RE\M12) can be ordered with an optional 20 cm cable to connect the detached network interfaces Ethernet (AIFX-RE) or Ethernet M12 (AIFX-RE\M12). See also **note** ⁸ in on page. In this case the part number is extended by "/20".⁷

8.10.3 Optional Cable Length 30 cm for PC-cards cifX with AIFX-DP, AIFX-CO or AIFX-DN

For the connection of the detached network interfaces fieldbus (AIFX-DP, AIFX-CO or AIFX-DN) for the PC cards cifX with the label "F" in the device name, cables with a length of 15 cm are supplied as standard.

The PC cards cifX fieldbus (with AIFX-DP, AIFX-CO or AIFX-DN) can be ordered with an optional 30 cm cable to connect the detached network interfaces fieldbus (AIFX-DP, AIFX-CO or AIFX-DN). See also **note** ⁹ in on *Table 16: Reference on Hardware PC Cards cifX* page 29 or *Table 17: Reference on Hardware: Basic Cards for PC Cards cifX, detached Network Interfaces AIFX* on page 30. In this case the part number is extended by "/30".

⁶ UL Certification: The cables CAB-AIFX-RE and CAB-AIFX-RE-15-2 are certified according to UL 508. UL-File-Nr. E221530

⁷ The cable CAB-AIFX-RE with 1 x20 pins for CIFX 90-RE\F and CIFX 104C-RE\F and their variants is currently only available as 15cm version.

8.11 SYNC Connector (Pin-Assignment, Hardware/Firmware)

8.11.1 Pin Assignment SYNC Connector, X51 (CIFX 80 90 104C)

Only for CIFX 80-RE, CIFX 90-RE\F, CIFX 90-RE\F\M12, CIFX 104C-RE, CIFX 104C-RE-R, CIFX 104C-RE\F, CIFX 104C-RE\F\M12, CIFX 104C-RE-R\F, CIFX 104C-RE-R\F\M12.

Pin	Signal
1	GND
2	IO_SYNC0
3	IO_SYNC1

Table 117: Pin Assignment for SYNC Connector, X51

CIFX 90E-RE\F, CIFX 90E-RE\F\M12, CIFX 90E-RE\NHS\F, CIFX 90E-RE\NHS\F\M12, CIFX 90E-RE\ET\F, CIFX 90E-RE\ET\F\M12, CIFX 90E-RE\MR\F, CIFX 90E-RE\MR\F\M12 und CIFX 90E-RE\MR\ET\F, CIFX 90E-RE\MR\ET\F\M12: The SYNC pins are on the Mini PCI Express bus (Pin 46, 44), refer to section *Pin Assignment for Mini PCI Express Bus / SYNC Connector (Bootstart), X1/X2*, on page 158.

8.11.2 Items on Hardware

Item	Explanation
SYNC Signal	3.3 V (LVTTTL), maximum load 6 mA
Connector	SYNC connector, X51 (for the PC cards cifX, as indicated under section <i>Pin Assignment SYNC Connector, X51</i> on page 154.) Female connector, 3 pin, pitch spacing 1.25 mm (for example, the type Molex series 51021) and female crimp contacts in design (e. g. type Molex series 50079/50058)
Max. Cable Length	Recommendation: Max. 50 mm Note: Take EMC into consideration for the cable laying

Table 118: SYNC Connector: SYNC Signal, Connector, Max. Cable Length

8.11.3 Items on Firmware

The loaded firmware determines if the signal is an input signal or output signal. The following table shows the meaning of the SYNC signals for the real-time Ethernet protocols currently offering SYNC signal support.

Protocol	Signal IO_SYNC0 Input/Output	Signal IO_SYNC1 Input/Output	From Firmware Version	Remarks
EtherCAT Slave	SYNC 0 Output	SYNC 1 Output	-	Configurable
PROFINET IO Device	Bus cycle start (PROFINET IRT) Output	-	3.4.x.x	-
sercos III Master	External trigger to start bus cycle Input Rising edge	-	2.0.8.0	-
sercos III Slave	CON_CLK Output	DIV_CLK Output	3.0.10.0	Configurable

Table 119: Meaning of the SYNC Signals for each Protocol

CIFX 104C-CO-R	2				
CIFX 104C-CO\F	2				
CIFX 104C-CO-R\F	2				
CIFX 104C-DN	2				
CIFX 104C-DN-R	2				
CIFX 104C-DN\F	2				
CIFX 104C-DN-R\F	2				
CIFX 104C-CC\F	2				

Table 120: Pin Assignment at the PCI Bus

8.12.2 Pin Assignment for Mini PCI Bus, X1

Only for: CIFX 90-RE\F, CIFX 90-RE\F\M12, CIFX 90-DP\F, CIFX 90-CO\F, CIFX 90-DN\F, CIFX 90-CC\F: (X1)

Pin (Top)	Signal	Pin (Bottom)	Signal
1	(not used)	2	(not used)
	Key		Key
3	(not used)	4	(not used)
5	(not used)	6	(not used)
7	(not used)	8	(not used)
9	(not used)	10	(not used)
11	(not used)	12	(not used)
13	(not used)	14	(not used)
15	(not used)	16	(not used)
17	(not used)	18	(not used)
19	3.3V	20	INTA#
21	(not used)	22	(not used)
23	GROUND	24	(not used)
25	CLK	26	RST#
27	GROUND	28	VIO: 3.3V or 5 V, depends on signal voltage
29	REQ#	30	GNT#
31	3.3V	32	GROUND
33	AD[31]	34	(not used)
35	AD[29]	36	(not used)
37	GROUND	38	AD[30]
39	AD[27]	40	3.3V
41	AD[25]	42	AD[28]
43	(not used)	44	AD[26]
45	C/BE[3]#	46	AD[24]
47	AD[23]	48	IDSEL
49	GROUND	50	GROUND
51	AD[21]	52	AD[22]
53	AD[19]	54	AD[20]
55	GROUND	56	PAR
57	AD[17]	58	AD[18]
59	C/BE[2]#	60	AD[16]
61	IRDY#	62	GROUND
63	3.3V	64	FRAME#
65	CLKRUN#	66	TRDY#
67	SERR#	68	STOP#

Pin (Top)	Signal	Pin (Bottom)	Signal
69	GROUND	70	3.3V
71	PERR#	72	DEVSEL#
73	C/BE[1]#	74	GROUND
75	AD[14]	76	AD[15]
77	GROUND	78	AD[13]
79	AD[12]	80	AD[11]
81	AD[10]	82	GROUND
83	GROUND	84	AD[09]
85	AD[08]	86	C/BE[0]#
87	AD[07]	88	(not used)
89	3.3V	90	AD[06]
91	AD[05]	92	AD[04]
93	(not used)	94	AD[02]
95	AD[03]	96	AD[00]
97	(not used)	98	(not used)
99	AD[01]	100	(not used)
101	GROUND	102	GROUND
103	(not used)	104	(not used)
105	(not used)	106	(not used)
107	(not used)	108	(not used)
109	(not used)	110	(not used)
111	(not used)	112	(not used)
113	(not used)	114	GROUND
115	(not used)	116	(not used)
117	(not used)	118	(not used)
119	(not used)	120	(not used)
121	(not used)	122	MPCIACT#, over 120 w to GROUND
123	(not used)	124	(not used)

Table 121: Pin Assignment for Mini PCI Bus, X1

The pin assignment described in *Table 121* originates from the standard pin assignment for Mini PCI Connector III [bus spec 4, page 14] (refer to section *References PCI Specifications* on page 264).

8.12.3 Pin Assignment for Mini PCI Express Bus / SYNC Connector (Bootstart), X1/X2

Only for Hardware Revision B: CIFX 90E-RE\F*, CIFX 90E-RE\F\M12*, CIFX 90E-DP\F, CIFX 90E-CO\F, CIFX 90E-DN\F, CIFX 90E-RE\MR\F*, CIFX 90E-RE\MR\F\M12*, CIFX 90E-DP\MR\F, CIFX 90E-CO\MR\F, CIFX 90E-DN\MR\F,

And for Hardware Revision 1: CIFX 90E-RE\NHS\F*, CIFX 90E-RE\NHS\F\M12*, CIFX 90E-DP\NHS\F, CIFX 90E-CO\NHS\F, CIFX 90E-DN\NHS\F, CIFX 90E-CC\NHS\F, CIFX 90E-RE\ET\F*, CIFX 90E-RE\ET\F\M12*, CIFX 90E-DP\ET\F, CIFX 90E-CO\ET\F, CIFX 90E-DN\ET\F, CIFX 90E-CC\ET\F, CIFX 90E-RE\MR\ET\F*, CIFX 90E-RE\MR\ET\F\M12*, CIFX 90E-DP\MR\ET\F, CIFX 90E-CO\MR\ET\F, CIFX 90E-DN\MR\ET\F, CIFX 90E-CC\MR\ET\F

*The SYNC connection is realized via the mini PCI Express bus.

Pin (X1)	Signal	Pin (X2)	Signal
51	(not used)	52	+3.3V
49	(not used)	50	GND
47	(not used)	48	(not used)
45	(not used)	46	IO_SYNC0 (not used with fieldbus protocols)
43	GND	44	IO_SYNC1 (not used with fieldbus protocols)
41	+3.3V	42	Bootstart
39	(not used)	40	GND
37	GND	38	USB_D+ (disabled – not used)
35	GND	36	USB_D- (disabled – not used)
33	PERp0 ⁸	34	GND
31	PERn0 ⁸	32	(not used)
29	GND	30	(not used)
27	GND	28	(not used)
25	PETp0 ⁸	26	GND
23	PETn0 ⁸	24	(not used)
21	GND	22	PERST#
19	(not used)	20	(not used)
17	(not used)	18	GND
15	GND	16	(not used)
13	REFCLK+	14	(not used)
11	REFCLK-	12	(not used)
9	GND	10	(not used)
7	CLKREQ#	8	(not used)
5	(not used)	6	(not used)
3	(not used)	4	GND
1	(not used)	2	3.3V

Table 122: Pin Assignment Mini PCI Express Bus / SYNC Connector, X1/X2

Unless otherwise noted, the pin assignment for Mini PCI Express bus, X1/X2 described in Table 122 corresponds to the bus specification for Mini PCI Express [bus spec 6, Rev. 1.2, Section 3.3].



Note! Note the following characteristics for the pin assignment of the Mini PCI Express Bus, X1/X2, described in Table 122:

- The Pins 6, 28, 48 and Pin 24 are ‘not used’.
- The Pins 36 and 38 are ‘not used’.
- The pin assignment of the Pins 42, 44, 46 deviates from the standard specification Mini PCI Express.

⁸ The names of the pins 33 and 31 with PER (,R' for ,Receive') and of the pins 25 and 23 with PET ('T' for ,Transmit') are defined in the view of the PC card cifX. The names in the bus specification are defined from the perspective of the host.



For the reference for [bus spec 6] for the bus specification for Mini PCI Express refer to section *References PCI Specifications* on page 264 of this manual.

About earlier Hardware Revisions refer to section *Notes on earlier Hardware Revisions* from page 273.

Pins 6, 28, 48

For the PC cards CIFX 90E-XX\F (all variants 'NHS', 'ET', 'MR' or with 'M12')⁹ the **Pins 6, 28, 48** are '**not used**', as listed in the *Table 122* on page 158.

Pin 24

For the PC cards CIFX 90E-XX\F (all variants 'NHS', 'ET', 'MR' or with 'M12') the **Pin 24** is '**not used**'.



Note: Due to how **pin 24** is used, the PC cards CIFX 90E-XX\F (all variants 'NHS', 'ET', 'MR' or with 'M12') can be used together with main boards according to any earlier revision (1.1 and 1.2) of the Mini PCI Express specification [bus spec 6], as well as to the latest revision (2.0).

Pins 36 and 38 (USB Connector)

The USB connector at the Mini PCI Express Bus of the PC cards CIFX 90E-XX\F (all variants 'NHS', 'ET', 'MR' or with 'M12') is directly connected to the CPU of the PC and is not used for external diagnosis.

- The **Pins 36 and 38** are disabled and are '**not used**'. When you start the PC, the operating system does not ask for an USB driver.

Pin 42 (Bootstart) and 44 , 46 (SYNC)

- **Pin 42 (Bootstart):** For all PC cards CIFX 90E-XX\F (all variants 'NHS', 'ET', 'MR' or with 'M12') **pin 42** is used for **Bootstart**.
- **Pins 44 , 46 (SYNC):** For the PC cards CIFX 90E-RE\F (all Real-Time Ethernet variants 'NHS', 'ET', 'MR' or with 'M12') depending by the protocol the **SYNC connection** is realized via the **pins 44 and 46** of the mini PCI Express bus. For further information to the SYNC pins (Pin 46, 44) refer to section *SYNC Connector (Pin-Assignment, Hardware/Firmware)* on page 154.

According to the bus specification for Mini PCI Express [bus spec 6] the pins are used to realize the LED status (Pin 42 „WWAN#“, Pin 44 „WLAN#“, Pin 46 „WPAN#“).

⁹ Variants of the PC card CIFX 90E-XX\F: CIFX 90E-XX\NHS\F, CIFX 90E-XX\ET\F, CIFX 90E-XX\MR\F or CIFX 90E-XX\MR\ET\F (XX = RE, DP, CO, DN or for the variants 'NHS', 'ET' and 'MR\ET' also = CC); as well as CIFX 90E-RE\F\M12, CIFX 90E-RE\NHS\F\M12, CIFX 90E-RE\ET\F\M12, CIFX 90E-RE\MR\F\M12, CIFX 90E-RE\MR\ET\F\M12

8.12.4 Pin Assignment for Mini PCI Express Bus, X1/X2 for 2 Channel Devices

Only for

CIFX 90E-2DP\ET\F, CIFX 90E-2DP\MR\ET\F
 CIFX 90E-2DP\CO\ET\F, CIFX 90E-2DP\CO\MR\ET\F
 CIFX 90E-2DP\DN\ET\F, CIFX 90E-2DP\DN\MR\ET\F
 CIFX 90E-2CO\ET\F, CIFX 90E-2CO\MR\ET\F
 CIFX 90E-2CO\DN\ET\F, CIFX 90E-2CO\DN\MR\ET\F
 CIFX 90E-2DN\ET\F, CIFX 90E-2DN\MR\ET\F (X3 and X4)

Pin Assignment Mini PCI Express Bus, X1/X2 for 2 Channel Devices

Pin (X1)	Signal	Pin (X2)	Signal
51	(not used)	52	+3.3V
49	(not used)	50	GND
47	(not used)	48	(not used)
45	(not used)	46	(not used)
43	GND	44	(not used)
41	+3.3V	42	Bootstart
39	(not used)	40	GND
37	GND	38	USB_D+ (<i>disabled – not used</i>)
35	GND	36	USB_D- (<i>disabled – not used</i>)
33	PERp0 ⁸	34	GND
31	PERn0 ⁸	32	(not used)
29	GND	30	(not used)
27	GND	28	(not used)
25	PETp0 ⁸	26	GND
23	PETn0 ⁸	24	(not used)
21	GND	22	PERST#
19	(not used)	20	(not used)
17	(not used)	18	GND
15	GND	16	(not used)
13	REFCLK+	14	(not used)
11	REFCLK-	12	(not used)
9	GND	10	(not used)
7	CLKREQ#	8	(not used)
5	(not used)	6	(not used)
3	(not used)	4	GND
1	(not used)	2	3.3V

Table 123: Pin Assignment Mini PCI Express Bus, X1/X2 for 2 Channel Devices

Unless otherwise noted, the pin assignment for Mini PCI Express bus, X1/X2 described in *Table 123* corresponds to the bus specification for Mini PCI Express [bus spec 6, Rev. 1.2, Section 3.3].



Note! Note the following characteristics for the pin assignment of the Mini PCI Express Bus, X1/X2, described in *Table 123*:

- The **Pins 6, 28, 48** and **Pin 24** are ‘**not used**’.
- The **Pins 36** and **38** are ‘**not used**’.
- The pin assignment of the **Pin 42** deviates from the standard specification Mini PCI Express. The **Pins 44** and **46** are ‘**not used**’.



For the reference for [bus spec 6] for the bus specification for Mini PCI Express refer to section *References PCI Specifications* on page 264 of this manual.

Pins 6, 28, 48

For the PC cards CIFX 90E-2FB\ET\F or CIFX 90E-2FB\MR\ET\F the **Pins 6, 28, 48** are '**not used**', as listed in the *Table 123* on page 160.

Pin 24

For the PC cards CIFX 90E-2FB\ET\F or CIFX 90E-2FB\MR\ET\F the **Pin 24** is '**not used**'.



Note: Due to how **pin 24** is used, the PC cards CIFX 90E-2FB\ET\F or CIFX 90E-2FB\MR\ET\F can be used together with main boards according to any earlier revision (1.1 and 1.2) of the Mini PCI Express specification [bus spec 6], as well as to the latest revision (2.0).

Pins 36 and 38 (USB Connector)

The USB connector at the Mini PCI Express Bus of the PC cards CIFX 90E-2FB\ET\F or CIFX 90E-2FB\MR\ET\F is directly connected to the CPU of the PC and is not used for external diagnosis.

- The **Pins 36 and 38** are disabled and are '**not used**'. When you start the PC, the operating system does not ask for an USB driver.

Pin 42 (Bootstart) and 44 , 46

- **Pin 42 (Bootstart):** For all PC cards CIFX 90E-2FB\ET\F or CIFX 90E-2FB\MR\ET\F **pin 42** is used for **Bootstart**.

For the PC cards CIFX 90E-2FB\ET\F or CIFX 90E-2FB\MR\ET\F the **Pins 44 and 48** are '**not used**', as listed in the *Table 123* on page 160.

According to the bus specification for Mini PCI Express [bus spec 6] the pins are used to realize the LED status (Pin 42 „WWAN#“, Pin 44 „WLAN#“, Pin 46 „WPAN#“).

9 Technical Data

9.1 Technical Data PC Cards cifX



Note: All technical data are temporarily and can be altered without notice.

9.1.1 CIFX 80-RE

CIFX 80-RE	Parameter	Value	
Part	Name, Part No.	CIFX 80-RE	1280.100
	Description	PC Card cifX Compact PCI for Real-Time Ethernet Master or Slave	
	Function	Communication interface with Compact PCI and Ethernet interface	
Communication Controller	Type	netX 100 processor	
Integrated Memory	RAM	8 MB SDRAM	
	FLASH	4 MB serial Flash EPROM	
	Size of the Dual-Port Memory	64 KByte	
System Interface	Bus Type	Compact PCI, according to [bus spec 4], refer to section <i>Overview</i> , page 155.	
	Transmission Rate	33 MHz	
	Data Access	DPM or DMA (Direct Memory Access)	
	Width for the data access to the Dual-Port Memory (DPM)	32-Bit	
Ethernet Communication	Supported Real-Time Ethernet communication systems (determined by the loaded firmware)	CC-Link IE Field Basic Slave	
		EtherCAT Master, EtherCAT Slave	
		EtherNet/IP Scanner (Master), EtherNet/IP Adapter (Slave),	
		Open Modbus/TCP	
		POWERLINK Controlled Node/Slave	
		PROFINET IO-Controller (Master), PROFINET IO-Device (Slave)	
		Sercos Master, Sercos Slave	
	VARAN Client (Slave)		
Ethernet Frame Types	Ethernet II		
Ethernet Interface	Transmission rate	100 MBit/s, 10 MBit/s (depending on loaded firmware)	
	Interface Type	100 BASE-TX, 10 BASE-T (depending on loaded firmware), refer to section <i>Ethernet Interface</i> , page 138.	
	Galvanic Isolation	isolated	
	Isolation Voltage	1000 VDC (tested for 1 minute)	
	Half duplex/Full duplex	depending on loaded firmware, supported (at 100 MBit/s)	
	Auto-Negotiation	depending on loaded firmware	
	Auto-Crossover	depending on loaded firmware	
	Connector	2* RJ45 Socket	
Diagnostic Interface	USB Interface	Mini B USB Plug (5 pin), refer to section <i>Mini-B USB Connector (5 Pin)</i> , page 143.	
Display	LED Display	SYS	System Status LED

CIFX 80-RE	Parameter	Value
		<p>The meaning of the following LEDs depends on the loaded firmware:</p> <p>COM 0 LED Communication Status 0 (duo LED)</p> <p>COM 1 LED Communication Status 1 (duo LED)</p> <p>LED yellow at RJ45Ch0 and RJ45Ch1,</p> <p>LED green for Ethernet Link status, Ethernet Activity status and additional status</p> <p>Refer to chapter <i>Diagnosis with LEDs</i>, page 104.</p>
Power supply	Supply Voltage	+3.3 V dc $\pm 5\%$, refer to section <i>Power Supply and Host Interface</i> on page 67.
	Current consumption at 3.3 V	650 mA (maximum)
	Connector	Via Compact PCI Bus
Environmental Conditions	Operating temperature range*	0 °C ... +70 °C
	*Air flow during measurement	0,5 m/s
	Storage temperature range	-40 °C ... +85 °C
	Humidity	10 ... 95% relative humidity, no condensation permitted
	Environment	For UL compliant usage: The device must be used in a pollution degree 2 environment.
Device	Dimensions (L x W x H)	162,5 x 100 x 20 mm
	Mounting/Installation	Compact PCI slot (3.3 V), refer to section <i>Slot for the PC Cards cifX Compact PCI, Mini PCI, Mini PCIe, PCI-104</i> , page 63.
	RoHS	Yes
Compliance with EMC	CE Sign	Yes
	UKCA Sign	Yes
	Emission	EN 55011+ A1, CISPR 11, Class A / BS EN 55011+ A1, CISPR 11, Class A (Radio disturbance characteristics - Limits and methods of measurement)
	Immunity	EN 61000-4-2 / BS EN 61000-4-2 (Electrostatic discharge test) EN 61000-4-3 + A1 + A2 / BS EN 61000-4-3 + A1 + A2 (Radiated, radio-frequency, electromagnetic field test) EN 61000-4-4 + A1 / BS EN 61000-4-4 + A1 (Burst Electrical fast transients/burst test) EN 61000-4-5 / BS EN 61000-4-5 (Surge test) EN 61000-4-6 / BS EN 61000-4-6 (to conducted disturbances, induced by radio- frequency fields) EN 61000-4-8 / BS EN 61000-4-8 (power frequency magnetic field test) EN 61000-6-2 + B1 / BS EN 61000-6-2 + B1 (for industrial environments)
UL Certification	The device CIFX 80-RE is certified according to UL 508	UL-File-Nr. E221530
Configuration	Configuration Software Master and Slave	SYCON.net
	Configuration Software Slave	netX Configuration Tool

Table 124: Technical Data CIFX 80-RE

9.1.2 CIFX 80-DP

CIFX 80-DP	Parameter	Value
Part	Name, Part No.	CIFX 80-DP 1280.410

CIFX 80-DP	Parameter	Value
	Description	PC Card cifX Compact PCI PROFIBUS DP Master or Slave and PROFIBUS MPI Device
	Function	Communication interface with Compact PCI and PROFIBUS interface
Communication Controller	Type	netX 100 processor
Integrated Memory	RAM	8 MB SDRAM
	FLASH	4 MB serial Flash EPROM
	Size of the Dual-Port Memory	64 KByte
System Interface	Bus Type	Compact PCI, according to [bus spec 4], refer to section <i>Overview</i> , page 155.
	Transmission Rate	33 MHz
	Data Access	DPM or DMA (Direct Memory Access)
	Width for the data access to the Dual-Port Memory (DPM)	32-Bit
PROFIBUS Communication	Supported communication standard/ protocol (determined by the loaded firmware)	PROFIBUS DP Master, PROFIBUS DP Slave, PROFIBUS MPI Device
PROFIBUS Interface	Transmission rate	9,6 kBit/s, 19,2 kBit/s, 31,25 kBit/s, 45,45 kBit/s, 93,75 kBit/s, 187,5 kBit/s, 500 kBit/s, 1,5 MBit/s, 3 MBit/s, 6 MBit/s, 12 MBit/s
	Interface Type	RS 485, refer to section <i>PROFIBUS Interface</i> page 141.
	Galvanic Isolation	isolated
	Isolation Voltage	1000 VDC (tested for 1 minute)
	Connector	DSub female Connector, 9 pin
Diagnostic Interface	USB Interface	Mini B USB Plug (5 pin), refer to section <i>Mini-B USB Connector (5 Pin)</i> , page 143.
Display	LED Display	SYS System Status LED COM LED Communication Status (duo LED) The meaning of the LED COM depends on the loaded firmware. Refer to chapter <i>Diagnosis with LEDs</i> , page 104.
Power supply	Supply Voltage	+3.3 V dc $\pm 5\%$, refer to section <i>Power Supply and Host Interface</i> on page 67.
	Current consumption at 3.3 V	650 mA (maximum)
	Connector	Via Compact PCI Bus
Environmental Conditions	Operating temperature range*	-20 °C ... +70 °C (acc. to UL: 0 °C ... +70 °C)
	*Air flow during measurement	0,5 m/s
	Storage temperature range	-40 °C ... +85 °C
	Humidity	10 ... 95% relative humidity, no condensation permitted
	Environment	For UL compliant usage: The device must be used in a pollution degree 2 environment.
Device	Dimensions (L x W x H)	162,5 x 100 x 20 mm
	Mounting/Installation	Compact PCI slot (3.3 V), refer to section <i>Slot for the PC Cards cifX Compact PCI, Mini PCI, Mini PCIe, PCI-104</i> , page 63.
	RoHS	Yes
Compliance with EMC	CE Sign	Yes
	UKCA Sign	Yes
	Emission	EN 55011+ A1, CISPR 11, Class A / BS EN 55011+ A1, CISPR 11, Class A (Radio disturbance characteristics - Limits and methods of measurement)

CIFX 80-DP	Parameter	Value
	Immunity	EN 61000-4-2 / BS EN 61000-4-2 (Electrostatic discharge test) EN 61000-4-3 + A1 + A2 / BS EN 61000-4-3 + A1 + A2 (Radiated, radio-frequency, electromagnetic field test) EN 61000-4-4 + A1 / BS EN 61000-4-4 + A1 (Burst Electrical fast transients/burst test) EN 61000-4-5 / BS EN 61000-4-5 (Surge test) EN 61000-4-6 / BS EN 61000-4-6 (to conducted disturbances, induced by radio- frequency fields) EN 61000-4-8 / BS EN 61000-4-8 (power frequency magnetic field test) EN 61000-6-2 + B1 / BS EN 61000-6-2 + B1 (for industrial environments)
UL Certification	The device CIFX 80-DP is certified according to UL 508	UL-File-Nr. E221530
Configuration	Configuration Software Master and Slave	SYCON.net
	Configuration Software Slave	netX Configuration Tool

Table 125: Technical Data CIFX 80-DP

9.1.3 CIFX 80-CO

CIFX 80-CO	Parameter	Value
Part	Name, Part No.	CIFX 80-CO 1280.500
	Description	PC Card cifX Compact PCI CANopen Master or Slave
	Function	Communication interface with Compact PCI and CANopen interface
Communication Controller	Type	netX 100 processor
Integrated Memory	RAM	8 MB SDRAM
	FLASH	4 MB serial Flash EPROM
	Size of the Dual-Port Memory	64 KByte
System Interface	Bus Type	Compact PCI, according to [bus spec 4], refer to section <i>Overview</i> , page 155.
	Transmission Rate	33 MHz
	Data Access	DPM or DMA (Direct Memory Access)
	Width for the data access to the Dual-Port Memory (DPM)	32-Bit
CANopen Communication	Supported communication standard/ protocol (determined by the loaded firmware)	CANopen Master, CANopen Slave
CANopen Interface	Transmission rate	10 kBit/s, 20 kBit/s, 50 kBit/s, 100 kBit/s, 125 kBit/s, 250 kBit/s, 500 kBit/s, 800 kBit/s, 1 MBit/s
	Interface Type	ISO-11898, refer to section <i>CANopen Interface</i> , page 141.
	Galvanic Isolation	optically isolated
	Isolation Voltage	1000 VDC (tested for 1 minute)
	Connector	DSub male Connector, 9 pin
Diagnostic Interface	USB Interface	Mini B USB Plug (5 pin), refer to section <i>Mini-B USB Connector (5 Pin)</i> , page 143.
Display	LED Display	SYS System Status LED
		CAN CANopen Status (duo LED)
		The meaning of the LED CAN depends on the loaded

CIFX 80-CO	Parameter	Value
		firmware. Refer to chapter <i>Diagnosis with LEDs</i> , page 104.
Power supply	Supply Voltage	+3.3 V dc $\pm 5\%$, refer to section <i>Power Supply and Host Interface</i> on page 67.
	Current consumption at 3.3 V	650 mA (maximum)
	Connector	Via Compact PCI Bus
Environmental Conditions	Operating temperature range*	-20 °C ... +70 °C (acc. to UL: 0 °C ... +70 °C)
	*Air flow during measurement	0,5 m/s
	Storage temperature range	-40 °C ... +85 °C
	Humidity	10 ... 95% relative humidity, no condensation permitted
	Environment	For UL compliant usage: The device must be used in a pollution degree 2 environment.
Device	Dimensions (L x W x H)	162,5 x 100 x 20 mm
	Mounting/Installation	Compact PCI slot (3.3 V), refer to section <i>Slot for the PC Cards cifX Compact PCI, Mini PCI, Mini PCIe, PCI-104</i> , page 63.
	RoHS	Yes
Compliance with EMC	CE Sign	Yes
	UKCA Sign	Yes
	Emission	EN 55011+ A1, CISPR 11, Class A / BS EN 55011+ A1, CISPR 11, Class A (Radio disturbance characteristics - Limits and methods of measurement)
	Immunity	EN 61000-4-2 / BS EN 61000-4-2 (Electrostatic discharge test) EN 61000-4-3 + A1 + A2 / BS EN 61000-4-3 + A1 + A2 (Radiated, radio-frequency, electromagnetic field test) EN 61000-4-4 + A1 / BS EN 61000-4-4 + A1 (Burst Electrical fast transients/burst test) EN 61000-4-5 / BS EN 61000-4-5 (Surge test) EN 61000-4-6 / BS EN 61000-4-6 (to conducted disturbances, induced by radio- frequency fields) EN 61000-4-8 / BS EN 61000-4-8 (power frequency magnetic field test) EN 61000-6-2 + B1 / BS EN 61000-6-2 + B1 (for industrial environments)
UL Certification	The device CIFX 80-CO is certified according to UL 508	UL-File-Nr. E221530
Configuration	Configuration Software Master and Slave	SYCON.net
	Configuration Software Slave	netX Configuration Tool

Table 126: Technical Data CIFX 80-CO

9.1.4 CIFX 80-DN

CIFX 80-DN	Parameter	Value
Part	Name, Part No.	CIFX 80-DN 1280.510
	Description	PC Card cifX Compact PCI DeviceNet Master or Slave
	Function	Communication interface with Compact PCI and DeviceNet interface
Communication Controller	Type	netX 100 processor
Integrated Memory	RAM	8 MB SDRAM

CIFX 80-DN	Parameter	Value
	FLASH	4 MB serial Flash EPROM
	Size of the Dual-Port Memory	64 KByte
System Interface	Bus Type	Compact PCI, according to [bus spec 4], refer to section <i>Overview</i> , page 155.
	Transmission Rate	33 MHz
	Data Access	DPM or DMA (Direct Memory Access)
	Width for the data access to the Dual-Port Memory (DPM)	32-Bit
DeviceNet Communication	Supported communication standard/ protocol (determined by the loaded firmware)	DeviceNet Master, DeviceNet Slave
DeviceNet Interface	Transmission rate	125 kBit/s, 250 kBit/s, 500 kBit/s
	Interface Type	ISO-11898 according to DeviceNet specification, refer to section <i>DeviceNet Interface</i> , page 142.
	Galvanic Isolation	optically isolated
	Isolation Voltage	1000 VDC (tested for 1 minute)
	Connector	CombiCon male Connector, 5 pin
Diagnostic Interface	USB Interface	Mini B USB Plug (5 pin), refer to section <i>Mini-B USB Connector (5 Pin)</i> , page 143.
Display	LED Display	<p>SYS System Status LED</p> <p>MNS Module Network Status (duo LED)</p> <p>The meaning of the LED MNS depends on the loaded firmware. Refer to chapter <i>Diagnosis with LEDs</i>, page 104.</p>
Power supply	Supply Voltage	+3.3 V dc $\pm 5\%$, refer to section <i>Power Supply and Host Interface</i> on page 67.
	Current consumption at 3.3 V	650 mA (maximum)
	Connector	Via Compact PCI Bus
Environmental Conditions	Operating temperature range*	-20 °C ... +70 °C (acc. to UL: 0 °C ... +70 °C)
	*Air flow during measurment	0,5 m/s
	Storage temperature range	-40 °C ... +85 °C
	Humidity	10 ... 95% relative humidity, no condensation permitted
	Environment	For UL compliant usage: The device must be used in a pollution degree 2 environment.
Device	Dimensions (L x W x H)	162,5 x 100 x 20 mm
	Mounting/Installation	Compact PCI slot (3.3 V), refer to section <i>Slot for the PC Cards cifX Compact PCI, Mini PCI, Mini PCIe, PCI-104</i> , page 63.
	RoHS	Yes
Compliance with EMC	CE Sign	Yes
	UKCA Sign	Yes
	Emission	EN 55011+ A1, CISPR 11, Class A / BS EN 55011+ A1, CISPR 11, Class A (Radio disturbance characteristics - Limits and methods of measurement)
	Immunity	EN 61000-4-2 / BS EN 61000-4-2 (Electrostatic discharge test) EN 61000-4-3 + A1 + A2 / BS EN 61000-4-3 + A1 + A2 (Radiated, radio-frequency, electromagnetic field test) EN 61000-4-4 + A1 / BS EN 61000-4-4 + A1 (Burst Electrical fast transients/burst test) EN 61000-4-5 / BS EN 61000-4-5 (Surge test) EN 61000-4-6 / BS EN 61000-4-6 (to conducted

CIFX 80-DN	Parameter	Value
		disturbances, induced by radio- frequency fields) EN 61000-4-8 / BS EN 61000-4-8 (power frequency magnetic field test) EN 61000-6-2 + B1 / BS EN 61000-6-2 + B1 (for industrial environments)
UL Certification	The device CIFX 80-DN is certified according to UL 508	UL-File-Nr. E221530
Configuration	Configuration Software Master and Slave	SYCON.net
	Configuration Software Slave	netX Configuration Tool

Table 127: Technical Data CIFX 80-DN

9.1.5 CIFX 90-RE\F, CIFX 90-RE\FM12

CIFX 90-RE\F, CIFX 90-RE\FM12	Parameter	Value	
Part	Name, Part No.	CIFX 90-RE\F	1290.100
		CIFX 90-RE\FM12	1290.120
	Description	PC Card cifX Mini PCI for Real-Time Ethernet Master or Slave composed of: - Basic card CIFX 90 with cable connector Ethernet X4 and - Ethernet detached network interface (AIFX-RE) or - Ethernet M12 detached network interface (AIFX-RE\M12) Note: The device height and the power input of the PC Card cifX Mini PCI CIFX 90-RE\F or CIFX 90-RE\FM12 do not comply with the standard specifications.	
	Function	Communication interface with Mini PCI and Ethernet interface	
Communication Controller	Type	netX 100 processor	
Integrated Memory	RAM	8 MB SDRAM	
	FLASH	4 MB serial Flash EPROM	
	Size of the Dual-Port Memory	64 KByte	
System Interface	Bus Type	Mini PCI, according to [bus spec 5], refer to section <i>Overview</i> , page 155 and <i>Pin Assignment for Mini PCI Bus, X1</i> , page 156.	
	Transmission Rate	33 MHz	
	Data Access	DPM or DMA (Direct Memory Access)	
	Width for the data access to the Dual-Port Memory (DPM)	32-Bit	
Ethernet Communication	Supported Real-Time Ethernet communication systems (determined by the loaded firmware)	CC-Link IE Field-Basic-Slave	
		EtherCAT Master, EtherCAT Slave	
		EtherNet/IP Scanner (Master), EtherNet/IP Adapter (Slave),	
		Open Modbus/TCP	
		POWERLINK Controlled Node/Slave	
		PROFINET IO-Controller (Master), PROFINET IO-Device (Slave)	
		Sercos Master, Sercos Slave	
	VARAN Client (Slave)		
Ethernet Frame Types	Ethernet II		
Ethernet Interface	Transmission rate	100 MBit/s, 10 MBit/s (depending on loaded firmware)	
	Interface Type	100 BASE-TX,	

CIFX 90-RE\F, CIFX 90-RE\F\M12	Parameter	Value
		10 BASE-T (depending on loaded firmware), refer to section <i>Ethernet Interface</i> , page 138.
	Half duplex/Full duplex	depending on loaded firmware, supported (at 100 MBit/s)
	Auto-Negotiation	depending on loaded firmware
	Auto-Crossover	depending on loaded firmware
	Detached network interface Ethernet, detached network interface Ethernet M12	AIFX-RE, refer to section <i>AIFX-RE</i> , page 218 or AIFX-RE\M12, refer to section <i>AIFX-RE\M12</i> , page 219. Important! Operating the PC card CIFX 90-RE\F or CIFX 90-RE\F\M12 requires proper connection of the Ethernet detached network interface (AIFX-RE) or the Ethernet M12 detached network interface (AIFX-RE\M12) to the basic card!
	Connector AIFX-RE or AIFX-RE\M12	Cable Connector Ethernet X4 (JST SM20B-SRSS-TB(LF)(SN), Pitch 1.0 mm)
Display	LED Display	SYS System Status LED
		For LEDs at AIFX-RE, refer to section <i>AIFX-RE</i> , page 218 or at AIFX-RE\M12, to section <i>AIFX-RE\M12</i> , page 219.
Power supply	Supply Voltage	+3.3 V dc $\pm 5\%$, refer to section <i>Power Supply and Host Interface</i> on page 67.
	Current consumption at 3.3 V	650 mA (maximum)
	Connector	Via Mini PCI PCI Bus
Environmental Conditions	Operating temperature range*	0 °C ... +70 °C
	*Air flow during measurement	0,5 m/s
	Storage temperature range	-40 °C ... +85 °C
	Humidity	10 ... 95% relative humidity, no condensation permitted
	Environment	For UL compliant usage: The device must be used in a pollution degree 2 environment.
Device	Dimensions (L x W x H)	60 x 45 x 11 mm
	Mounting/Installation	Mini PCI Socket (3.3 V), Type III System Connector, refer to section <i>Slot for the PC Cards cifX Compact PCI, Mini PCI, Mini PCIe, PCI-104</i> , page 63.
	RoHS	Yes
Compliance with EMC	CE Sign	Yes
	UKCA Sign	Yes
	Emission	EN 55011+ A1, CISPR 11, Class A / BS EN 55011+ A1, CISPR 11, Class A (Radio disturbance characteristics - Limits and methods of measurement)
	Immunity	EN 61000-4-2 / BS EN 61000-4-2 (Electrostatic discharge test) EN 61000-4-3 + A1 + A2 / BS EN 61000-4-3 + A1 + A2 (Radiated, radio-frequency, electromagnetic field test) EN 61000-4-4 + A1 / BS EN 61000-4-4 + A1 (Burst Electrical fast transients/burst test) EN 61000-4-5 / BS EN 61000-4-5 (Surge test) EN 61000-4-6 / BS EN 61000-4-6 (to conducted disturbances, induced by radio- frequency fields) EN 61000-4-8 / BS EN 61000-4-8 (power frequency magnetic field test) EN 61000-6-2 + B1 / BS EN 61000-6-2 + B1 (for industrial environments)
UL Certification	The device CIFX 90-RE\F is certified according to UL 508	UL-File-Nr. E221530
Configuration	Configuration Software	SYCON.net

CIFX 90-RE\F, CIFX 90-RE\FM12	Parameter	Value
	Master and Slave	
	Configuration Software Slave	netX Configuration Tool

Table 128: Technical Data CIFX 90-RE\F, CIFX 90-RE\FM12

9.1.6 CIFX 90-DP\F

CIFX 90E-DP\F	Parameter	Value
Part	Name, Part No.	CIFX 90-DP\F 1290.410
	Description	PC Card cifX Mini PCI PROFIBUS DP Master or Slave and PROFIBUS MPI Device composed of: - Basic card CIFX 90 with cable connector Fieldbus X3 and - PROFIBUS detached network interface (AIFX-DP). Note: The device height and the power input of the PC Card cifX Mini PCI CIFX 90-DP\F do not comply with the standard specifications.
	Function	Communication interface with Mini PCI-Socket and PROFIBUS interface
Communication Controller	Type	netX 100 processor
Integrated Memory	RAM	8 MB SDRAM
	FLASH	4 MB serial Flash EPROM
	Size of the Dual-Port Memory	64 KByte
System Interface	Bus Type	Mini PCI, according to [bus spec 5], refer to section <i>Overview</i> , page 155 and <i>Pin Assignment for Mini PCI Bus, X1</i> , page 156.
	Transmission Rate	33 MHz
	Data Access	DPM or DMA (Direct Memory Access)
	Width for the data access to the Dual-Port Memory (DPM)	32-Bit
PROFIBUS Communication	Supported communication standard/ protocol (determined by the loaded firmware)	PROFIBUS DP Master, PROFIBUS DP Slave, PROFIBUS MPI Device
PROFIBUS Interface	Transmission rate	9,6 kBit/s, 19,2 kBit/s, 31,25 kBit/s, 45,45 kBit/s, 93,75 kBit/s, 187,5 kBit/s, 500 kBit/s, 1,5 MBit/s, 3 MBit/s, 6 MBit/s, 12 MBit/s
	Interface Type	RS 485, refer to section <i>PROFIBUS Interface</i> page 141.
	PROFIBUS detached Network Interface	AIFX-DP, refer to section <i>AIFX-DP</i> page 220. Important! Operating the PC card CIFX 90-DP\F requires proper connection of the PROFIBUS detached network interface (AIFX-DP) to the basic card!
	Connector AIFX-DP	Connector Fieldbus X3 (JST 10FMN-SMT-A-TF(LF)(SN), Pitch 1,0 mm)
Display	LED Display	SYS System Status LED
		For LEDs at AIFX-DP, refer to section <i>AIFX-DP</i> page 220.
Power supply	Supply Voltage	+3.3 V dc $\pm 5\%$, refer to section <i>Power Supply and Host Interface</i> on page 67.
	Current consumption at 3.3 V	650 mA (maximum)
	Connector	Via Mini PCI Bus
Environmental Conditions	Operating temperature range*	-20 °C ... +70 °C (acc. to UL: 0 °C ... +70 °C)
	*Air flow during measurment	0,5 m/s
	Storage temperature range	-40 °C ... +85 °C
	Humidity	10 ... 95% relative humidity, no condensation permitted

CIFX 90E-DPVF	Parameter	Value
	Environment	For UL compliant usage: The device must be used in a pollution degree 2 environment.
Device	Dimensions (L x W x H)	60 x 45 x 11 mm
	Mounting/Installation	Mini PCI Socket (3.3 V), Type III System Connector, refer to section <i>Slot for the PC Cards cifX Compact PCI, Mini PCI, Mini PCIe, PCI-104</i> , page 63.
	RoHS	Yes
Compliance with EMC	CE Sign	Yes
	UKCA Sign	Yes
	Emission	EN 55011+ A1, CISPR 11, Class A / BS EN 55011+ A1, CISPR 11, Class A (Radio disturbance characteristics - Limits and methods of measurement)
	Immunity	EN 61000-4-2 / BS EN 61000-4-2 (Electrostatic discharge test) EN 61000-4-3 + A1 + A2 / BS EN 61000-4-3 + A1 + A2 (Radiated, radio-frequency, electromagnetic field test) EN 61000-4-4 + A1 / BS EN 61000-4-4 + A1 (Burst Electrical fast transients/burst test) EN 61000-4-5 / BS EN 61000-4-5 (Surge test) EN 61000-4-6 / BS EN 61000-4-6 (to conducted disturbances, induced by radio- frequency fields) EN 61000-4-8 / BS EN 61000-4-8 (power frequency magnetic field test) EN 61000-6-2 + B1 / BS EN 61000-6-2 + B1 (for industrial environments)
UL Certification	The device CIFX 90-DPVF is certified according to UL 508	UL-File-Nr. E221530
Configuration	Configuration Software Master and Slave	SYCON.net
	Configuration Software Slave	netX Configuration Tool

Table 129: Technical Data CIFX 90-DPVF

9.1.7 CIFX 90-CO\F

CIFX 90-CO\F	Parameter	Value
Part	Name, Part No.	CIFX 90-CO\F 1290.500
	Description	PC Card cifX Mini PCI CANopen Master or Slave composed of: - Basic card CIFX 90 with cable connector Fieldbus X3 and - CANopen detached network interface (AIFX-CO). Note: The device height and the power input of the PC Card cifX Mini PCI CIFX 90-CO\F do not comply with the standard specifications.
	Function	Communication interface with Mini PCI-Socket and CANopen interface
Communication Controller	Type	netX 100 processor
Integrated Memory	RAM	8 MB SDRAM
	FLASH	4 MB serial Flash EPROM
	Size of the Dual-Port Memory	64 KByte
System Interface	Bus Type	Mini PCI, according to [bus spec 5], refer to section <i>Overview</i> , page 155 and <i>Pin Assignment for Mini PCI Bus, X1</i> , page 156.
	Transmission Rate	33 MHz

CIFX 90-COVF	Parameter	Value
	Data Access	DPM or DMA (Direct Memory Access)
	Width for the data access to the Dual-Port Memory (DPM)	32-Bit
CANopen Communication	Supported communication standard/ protocol (determined by the loaded firmware)	CANopen Master, CANopen Slave
CANopen Interface	Transmission rate	10 kBit/s, 20 kBit/s, 50 kBit/s, 100 kBit/s, 125 kBit/s, 250 kBit/s, 500 kBit/s, 800 kBit/s, 1 MBit/s
	Interface Type	ISO-11898, refer to section <i>CANopen Interface</i> , page 141.
	CANopen detached Network Interface	AIFX-CO, refer to section <i>AIFX-CO</i> , page 221. Important! Operating the PC card CIFX 90-COVF requires proper connection of the CANopen detached network interface (AIFX-CO) to the basic card!
	Connector AIFX-CO	Connector Fieldbus X3 (JST 10FMN-SMT-A-TF(LF)(SN), Pitch 1,0 mm)
Display	LED Display	SYS System Status LED
		For LEDs at AIFX-CO, refer to section <i>AIFX-CO</i> , p. 221.
Power supply	Supply Voltage	+3.3 V dc $\pm 5\%$, refer to section <i>Power Supply and Host Interface</i> on page 67.
	Current consumption at 3.3 V	650 mA (maximum)
	Connector	Via Mini PCI Bus
Environmental Conditions	Operating temperature range*	-20 °C ... +70 °C (acc. to UL: 0 °C ... +70 °C)
	*Air flow during measurement	0,5 m/s
	Storage temperature range	-40 °C ... +85 °C
	Humidity	10 ... 95% relative humidity, no condensation permitted
	Environment	For UL compliant usage: The device must be used in a pollution degree 2 environment.
Device	Dimensions (L x W x H)	60 x 45 x 11 mm
	Mounting/Installation	Mini PCI Socket (3.3 V), Type III System Connector, refer to section <i>Slot for the PC Cards cifX Compact PCI, Mini PCI, Mini PCIe, PCI-104</i> , page 63.
	RoHS	Yes
Compliance with EMC	CE Sign	Yes
	UKCA Sign	Yes
	Emission	EN 55011+ A1, CISPR 11, Class A / BS EN 55011+ A1, CISPR 11, Class A (Radio disturbance characteristics - Limits and methods of measurement)
	Immunity	EN 61000-4-2 / BS EN 61000-4-2 (Electrostatic discharge test) EN 61000-4-3 + A1 + A2 / BS EN 61000-4-3 + A1 + A2 (Radiated, radio-frequency, electromagnetic field test) EN 61000-4-4 + A1 / BS EN 61000-4-4 + A1 (Burst Electrical fast transients/burst test) EN 61000-4-5 / BS EN 61000-4-5 (Surge test) EN 61000-4-6 / BS EN 61000-4-6 (to conducted disturbances, induced by radio- frequency fields) EN 61000-4-8 / BS EN 61000-4-8 (power frequency magnetic field test) EN 61000-6-2 + B1 / BS EN 61000-6-2 + B1 (for industrial environments)
UL Certification	The device CIFX 90-COVF is certified according to UL 508	UL-File-Nr. E221530

CIFX 90-COIF	Parameter	Value
Configuration	Configuration Software Master and Slave	SYCON.net
	Configuration Software Slave	netX Configuration Tool

Table 130: Technical Data CIFX 90-COIF

9.1.8 CIFX 90-DNF

CIFX 90-DNF	Parameter	Value
Part	Name, Part No.	CIFX 90-DNF 1290.510
	Description	PC Card cifX Mini PCI DeviceNet Master or Slave composed of: - Basic card CIFX 90 with cable connector Fieldbus X3 and - DeviceNet detached network interface (AIFX-DN). Note: The device height and the power input of the PC Card cifX Mini PCI CIFX 90-DNF do not comply with the standard specifications.
	Function	Communication interface with Mini PCI-Socket and DeviceNet interface
Communication Controller	Type	netX 100 processor
Integrated Memory	RAM	8 MB SDRAM
	FLASH	4 MB serial Flash EPROM
	Size of the Dual-Port Memory	64 KByte
System Interface	Bus Type	Mini PCI, according to [bus spec 5], refer to section <i>Overview</i> , page 155 and <i>Pin Assignment for Mini PCI Bus, X1</i> , page 156.
	Transmission Rate	33 MHz
	Data Access	DPM or DMA (Direct Memory Access)
	Width for the data access to the Dual-Port Memory (DPM)	32-Bit
DeviceNet Communication	Supported communication standard/ protocol (determined by the loaded firmware)	DeviceNet Master, DeviceNet Slave
DeviceNet Interface	Transmission rate	125 kBit/s, 250 kBit/s, 500 kBit/s
	Interface Type	ISO-11898 according to DeviceNet specification, refer to section <i>DeviceNet Interface</i> , page 142
	DeviceNet detached Network Interface	AIFX-DN, refer to section <i>AIFX-DN</i> , page 222. Important! Operating the PC card CIFX 90-DNF requires proper connection of the DeviceNet detached network interface (AIFX-DN) to the basic card!
	Connector AIFX-DN	Connector Fieldbus X3 (JST 10FMN-SMT-A-TF(LF)(SN), Pitch 1,0 mm)
Display	LED Display	SYS System Status LED For LED at AIFX-DN, refer to section <i>AIFX-DN</i> , p. 222.
Power supply	Supply Voltage	+3.3 V dc ±5 %, refer to section <i>Power Supply and Host Interface</i> on page 67.
	Current consumption at 3.3 V	650 mA (maximum)
	Connector	Via Mini PCI Bus
Environmental Conditions	Operating temperature range*	-20 °C ... +70 °C (acc. to UL: 0 °C ... +70 °C)
	*Air flow during measurement	0,5 m/s
	Storage temperature range	-40 °C ... +85 °C
	Humidity	10 ... 95% relative humidity, no condensation permitted

CIFX 90-DNF	Parameter	Value
	Environment	For UL compliant usage: The device must be used in a pollution degree 2 environment.
Device	Dimensions (L x W x H)	60 x 45 x 11 mm
	Mounting/Installation	Mini PCI Socket (3.3 V), Type III System Connector, refer to section <i>Slot for the PC Cards cifX Compact PCI, Mini PCI, Mini PCIe, PCI-104</i> , page 63.
	RoHS	Yes
Compliance with EMC	CE Sign	Yes
	UKCA Sign	Yes
	Emission	EN 55011+ A1, CISPR 11, Class A / BS EN 55011+ A1, CISPR 11, Class A (Radio disturbance characteristics - Limits and methods of measurement)
	Immunity	EN 61000-4-2 / BS EN 61000-4-2 (Electrostatic discharge test) EN 61000-4-3 + A1 + A2 / BS EN 61000-4-3 + A1 + A2 (Radiated, radio-frequency, electromagnetic field test) EN 61000-4-4 + A1 / BS EN 61000-4-4 + A1 (Burst Electrical fast transients/burst test) EN 61000-4-5 / BS EN 61000-4-5 (Surge test) EN 61000-4-6 / BS EN 61000-4-6 (to conducted disturbances, induced by radio- frequency fields) EN 61000-4-8 / BS EN 61000-4-8 (power frequency magnetic field test) EN 61000-6-2 + B1 / BS EN 61000-6-2 + B1 (for industrial environments)
UL Certification	The device CIFX 90-DNF is certified according to UL 508	UL-File-Nr. E221530
Configuration	Configuration Software Master and Slave	SYCON.net
	Configuration Software Slave	netX Configuration Tool

Table 131: Technical Data CIFX 90-DNF

9.1.9 CIFX 90-CC\F

CIFX 90-CC\F	Parameter	Value
Part	Name, Part No.	CIFX 90-CC\F 1290.740
	Description	PC Card cifX Mini PCI CC-Link Slave composed of: - Basic card CIFX 90 with cable connector Fieldbus X3 and - CC-Link detached network interface (AIFX-CC). Note: The device height and the power input of the PC Card cifX Mini PCI CIFX 90-CC\F do not comply with the standard specifications.
	Function	Communication interface with Mini PCI-Socket and CC-Link interface
Communication Controller	Type	netX 100 processor
Integrated Memory	RAM	8 MB SDRAM
	FLASH	4 MB serial Flash EPROM
	Size of the Dual-Port Memory	64 KByte
System Interface	Bus Type	Mini PCI, according to [bus spec 5], refer to section <i>Overview</i> , page 155 and <i>Pin Assignment for Mini PCI Bus, X1</i> , page 156.
	Transmission Rate	33 MHz

CIFX 90-CC\F	Parameter	Value
	Data Access	DPM or DMA (Direct Memory Access)
	Width for the data access to the Dual-Port Memory (DPM)	32-Bit
CC-Link Communication	Supported communication standard/ protocol (determined by the loaded firmware)	CC-Link Slave
CC-Link Interface	Transmission rate	156 kBit/s, 625 kBit/s, 2500 kBit/s, 5 MBit/s, 10 MBit/s
	Interface Type	RS-485, refer to section <i>CC-Link Interface</i> , page 142.
	CC-Link detached Network Interface	AIFX-CC, refer to section <i>AIFX-CC</i> , page 223. Important! Operating the PC card CIFX 90-CC\F requires proper connection of the CC-Link detached network interface (AIFX-CC) to the basic card!
	Connector AIFX-CC	Connector Fieldbus X3 (JST 10FMN-SMT-A-TF(LF)(SN), Pitch 1,0 mm)
Display	LED Display	SYS System Status LED
		For LEDs at AIFX-CC, refer to section <i>AIFX-CC</i> , p. 223.
Power supply	Supply Voltage	+3.3 V dc $\pm 5\%$, refer to section <i>Power Supply and Host Interface</i> on page 67.
	Current consumption at 3.3 V	650 mA (maximum)
	Connector	Via Mini PCI Bus
Environmental Conditions	Operating temperature range*	0 °C ... +60 °C
	*Air flow during measurment	0,5 m/s
	Storage temperature range	-40 °C ... +85 °C
	Humidity	10 ... 95% relative humidity, no condensation permitted
Device	Dimensions (L x W x H)	60 x 45 x 11 mm
	Mounting/Installation	Mini PCI Socket (3.3 V), Type III System Connector, refer to section <i>Slot for the PC Cards cifX Compact PCI, Mini PCI, Mini PCIe, PCI-104</i> , page 63.
	RoHS	Yes
Compliance with EMC	CE Sign	Yes
	UKCA Sign	Yes
	Emission	EN 55011+ A1, CISPR 11, Class A / BS EN 55011+ A1, CISPR 11, Class A (Radio disturbance characteristics - Limits and methods of measurement)
	Immunity	EN 61000-4-2 / BS EN 61000-4-2 (Electrostatic discharge test) EN 61000-4-3 + A1 + A2 / BS EN 61000-4-3 + A1 + A2 (Radiated, radio-frequency, electromagnetic field test) EN 61000-4-4 + A1 / BS EN 61000-4-4 + A1 (Burst Electrical fast transients/burst test) EN 61000-4-5 / BS EN 61000-4-5 (Surge test) EN 61000-4-6 / BS EN 61000-4-6 (to conducted disturbances, induced by radio- frequency fields) EN 61000-4-8 / BS EN 61000-4-8 (power frequency magnetic field test) EN 61000-6-2 + B1 / BS EN 61000-6-2 + B1 (for industrial environments)
Configuration	Configuration Software	SYCON.net or netX Configuration Tool

Table 132: Technical Data CIFX 90-CC\F

9.1.10 CIFX 90E-RE\F and Variants

CIFX 90E-RE\F and Variants	Parameter	Value	
Part	Name, Part No.	CIFX 90E-RE\F	1291.100
		CIFX 90E-RE\NHS\F	1291.108
		CIFX 90E-RE\ET\F	1291.104
		CIFX 90E-RE\MR\F	1291.102
		CIFX 90E-RE\MR\ET\F	1291.106
		CIFX 90E-RE\F\M12	1291.120
		CIFX 90E-RE\NHS\F\M12	1291.128
		CIFX 90E-RE\ET\F\M12	1291.124
		CIFX 90E-RE\MR\F\M12	1291.122
		CIFX 90E-RE\MR\ET\F\M12	1291.126
Part	Description	PC Card cifX Mini PCI Express for Real-Time Ethernet Master or Slave (and variants ‚NHS‘ =no heat sink, with enlarged temperature range ‚ET‘ and/or additional MRAM ‚MR‘) composed of: - Basic card CIFX 90E, CIFX 90E\NHS, CIFX 90E\ET, CIFX 90E\MR or CIFX 90E\MR\ET with cable connector Ethernet X4 and - Ethernet detached network interface (AIFX-RE) - Ethernet M12 detached network interface (AIFX-RE\M12) Note: The device height and the power input of the PC Card cifX Mini PCI Express CIFX 90E-RE\F, CIFX 90E-RE\NHS\F, CIFX 90E-RE\ET\F, CIFX 90E-RE\MR\F and CIFX 90E-RE\MR\ET\F, CIFX 90E-RE\F\M12, CIFX 90E-RE\NHS\F\M12, CIFX 90E-RE\ET\F\M12, CIFX 90E-RE\MR\F\M12 and CIFX 90E-RE\MR\ET\F\M12 do not comply with the standard specifications.	
	Function	Communication Interface with Mini PCI Express and Ethernet interface	
Communication Controller	Type	netX 100 processor	
Integrated Memory	RAM	8 MB SDRAM	
	FLASH	4 MB serial Flash EPROM	
	Size of the Dual-Port Memory	64 KByte	
	MRAM (only CIFX 90E-RE\MR\F, CIFX 90E-RE\MR\ET\F, CIFX 90E-RE\MR\F\M12 or CIFX 90E-RE\MR\ET\F\M12)	128Kbyte (= 64K Words); Note: Using the cifX Device Driver (from Version 1.1.1.0) access to this memory is possible and it can be used as a remanent memory.	
System Interface	Bus Type	Mini PCI Express, One Lane Port, according to [bus spec 2], refer to section <i>Overview</i> , page 155 and <i>Pin Assignment for Mini PCI Express Bus / SYNC Connector (Bootstart)</i> , X1/X2, page 158.	
	Transmission Rate	33 MHz	
	Data Access	DPM or DMA* (Direct Memory Access); *CIFX 90E-RE\F from Hardware Revision A, CIFX 90E-RE\MR\F from Hardware Revision B, CIFX 90E-RE\NHS\F, CIFX 90E-RE\ET\F and CIFX 90E-RE\MR\ET\F from Hardware Revision 1 These specifications also apply to the variants with the Ethernet M12 detached network interface AIFX-RE/M12.	
	Width for the data access to the Dual-Port Memory (DPM)	32-Bit	
Ethernet Communication	Supported Real-Time Ethernet communication systems (determined by the loaded firmware)	CC-Link IE Field Basic Slave	
		EtherCAT Master, EtherCAT Slave	
		EtherNet/IP Scanner (Master), EtherNet/IP Adapter (Slave),	

CIFX 90E-RE\F and Variants	Parameter	Value		
		Open Modbus/TCP		
		POWERLINK Controlled Node/Slave		
		PROFINET IO-Controller (Master), PROFINET IO-Device (Slave)		
		Sercos Master, Sercos Slave		
		VARAN Client (Slave)		
	Ethernet Frame Types	Ethernet II		
Ethernet Interface	Transmission Rate	100 MBit/s, 10 MBit/s (depending on loaded firmware)		
	Interface Type	100 BASE-TX, 10 BASE-T (depending on loaded firmware), refer to section <i>Ethernet Interface</i> , page 138.		
	Half duplex/Full duplex	depending on loaded firmware, supported (at 100 MBit/s)		
	Auto-Negotiation	depending on loaded firmware		
	Auto-Crossover	depending on loaded firmware		
	Detached network interface Ethernet, detached network interface Ethernet M12	AIFX-RE, refer to section <i>AIFX-RE</i> , page 218 or at AIFX-RE\M12, to section <i>AIFX-RE\M12</i> , page 219. Important! Operating the PC card CIFX 90E-RE\F (all variants 'NHS', 'ET', 'MR' or with 'M12') requires proper connection of the Ethernet detached network interface (AIFX-RE) or the Ethernet M12 detached network interface (AIFX-RE\M12) to the basic card!		
	Connector AIFX-RE or AIFX-RE\M12	Cable Connector Ethernet X4 (JST BM20B-SRDS-A-G-TF, Pitch 1,0 mm)		
Display	LED Display	SYS System Status LED		
		For LEDs at AIFX-RE, refer to section <i>AIFX-RE</i> , page 218 or at AIFX-RE\M12, to section <i>AIFX-RE\M12</i> , page 219.		
Power supply	Supply Voltage	+3.3 V dc $\pm 5\%$, refer to section <i>Power Supply and Host Interface</i> on page 67. <i>Important!</i> For all PC cards cifX Mini PCI Express, the increase of the supply voltage from 0V to 3.3V must last longer than 180 μ s.		
	Current consumption at 3.3 V	800 mA (maximum)		
	Connector	Via Mini PCI Express Bus		
Environmental Conditions	Operating temperature range* (valid for AIFX-RE hardware rev. 3)	CIFX 90E-RE\ET\F	CIFX 90E-RE\F	CIFX 90E-RE\NHS\F
		-	CIFX 90E-RE\MR\F	-
		-	CIFX 90E-RE\F\M12	CIFX 90E-RE\NHS\F\M12
		CIFX 90E-RE\MR\ET\F\M12	CIFX 90E-RE\MR\F\M12	-
		-20 °C ... +70 °C	-20 °C ... +55 °C	-20 °C ... +45 °C
	*Air flow during measurement	0,5 m/s	0,5 m/s	0,0m/s
	Storage temperature range	-40 °C ... +85 °C		
	Humidity	10 ... 95% relative humidity, no condensation permitted		
Environment	For UL compliant usage: The device must be used in a pollution degree 2 environment.			
Device	Dimensions (L x W x H)	CIFX 90E-RE\F ^{1,2} , CIFX 90E-RE\MR\F ² , CIFX 90E-RE\F\M12 ^{1,2} , CIFX 90E-RE\MR\F\M12 ²	51 x 30,2 +/- 0,1 x 11 mm	
		CIFX 90E-RE\NHS\F, CIFX 90E-RE\NHS\F\M12	51 x 30,2 +/- 0,1 x 10,8 mm	
		CIFX 90E-RE\ET\F, CIFX 90E-RE\MR\ET\F, CIFX 90E-RE\ET\F\M12, CIFX 90E-RE\MR\ET\F\M12	51 x 30,2 +/- 0,1 x 12,5 mm	

CIFX 90E-REVF and Variants	Parameter	Value
		<p>²Beginning with hardware revision A: 51 x 30,2 mm + 0,1 / - 0,1 mm x 11 mm; [W = 30,1mm ... 30,3 mm: The printed circuit board (PCB) has become wider on the right side by 0.1 mm ... 0.3 mm, thus deviating from the norm].</p> <p>¹For hardware revision 9: 51 x 30,2 x 11 mm; [W = 30,2 mm: The printed circuit board (PCB) has become wider on the right side by 0.2 mm, thus deviating from the norm].</p> <p>For further details on the element heights refer to section <i>Notes on the Card Height - PC Card cifX Mini PCI and Mini PCIe</i> on page 64.</p>
	Mounting/Installation	PCI Express Mini System Connector (3.3 V), X1/X2 ¹⁰ = One Lane, refer to section <i>Slot for the PC Cards cifX Compact PCI, Mini PCI, Mini PCIe, PCI-104</i> , page 63.
	RoHS	Yes
Compliance with EMC	CE Sign	Yes
	UKCA Sign	Yes
	Emission	EN 55011+ A1, CISPR 11, Class A / BS EN 55011+ A1, CISPR 11, Class A (Radio disturbance characteristics - Limits and methods of measurement)
	Immunity	EN 61000-4-2 / BS EN 61000-4-2 (Electrostatic discharge test) EN 61000-4-3 + A1 + A2 / BS EN 61000-4-3 + A1 + A2 (Radiated, radio-frequency, electromagnetic field test) EN 61000-4-4 + A1 / BS EN 61000-4-4 + A1 (Burst Electrical fast transients/burst test) EN 61000-4-5 / BS EN 61000-4-5 (Surge test) EN 61000-4-6 / BS EN 61000-4-6 (to conducted disturbances, induced by radio- frequency fields) EN 61000-4-8 / BS EN 61000-4-8 (power frequency magnetic field test) EN 61000-6-2 + B1 / BS EN 61000-6-2 + B1 (for industrial environments)
UL Certification	The device CIFX 90E-REVF is certified according to UL 508	UL-File-Nr. E221530
Configuration	Configuration Software Master and Slave	SYCON.net
	Configuration Software Slave	netX Configuration Tool

Table 133: Technical Data CIFX 90E-REVF, CIFX 90E-REWNHS\F, CIFX 90E-REVET\F, CIFX 90E-REWMR\F, CIFX 90E-REWMR\ET\F and Variants with AIFX-REWM12

9.1.11 CIFX 90E-DP\F and Variants

CIFX 90E-DP\F and Variants	Parameter	Value	
Part	Name, Part No.	CIFX 90E-DP\F	1291.410
		CIFX 90E-DP\NHS\F	1291.418
		CIFX 90E-DP\ET\F	1291.414
		CIFX 90E-DP\MR\F	1291.412
		CIFX 90E-DP\MR\ET\F	1291.416

¹⁰ X1, X2 corresponds to the Hilscher convention for „interface“ on the top or the bottom side of the PC Card cifX.

CIFX 90E-DP\F and Variants	Parameter	Value
	Description	<p>PC Card cifX Mini PCI Express PROFIBUS DP Master or Slave and PROFIBUS MPI Device (and variants ‚NHS‘ =no heat sink, with enlarged temperature range ‚ET‘ and/or additional MRAM ‚MR‘) composed of:</p> <ul style="list-style-type: none"> - Basic card CIFX 90E, CIFX 90E\NHS, CIFX 90E\ET, CIFX 90E\MR or CIFX 90E\MR\ET with cable connector Fieldbus X3 and - PROFIBUS detached network interface (AIFX-DP). <p>Note: The device height and the power input of the PC Card cifX Mini PCI Express CIFX 90E-DP\F, CIFX 90E-DP\NHS\F, CIFX 90E-DP\ET\F, CIFX 90E-DP\MR\F and CIFX 90E-DP\MR\ET\F do not comply with the standard specifications.</p>
	Function	Communication Interface with Mini PCI Express and PROFIBUS interface
Communication Controller	Type	netX 100 processor
Integrated Memory	RAM	8 MB SDRAM
	FLASH	4 MB serial Flash EPROM
	Size of the Dual-Port Memory	64 KByte
	MRAM (only CIFX 90E-DP\MR\F and CIFX 90E-DP\MR\ET\F)	128Kbyte (= 64K Words); Note: Using the cifX Device Driver (from Version 1.1.1.0) access to this memory is possible and it can be used as a remanent memory.
System Interface	Bus Type	Mini PCI Express One Lane Port, according to [bus spec 2] and [bus spec 6], refer to section <i>Overview</i> , page 155 and <i>Pin Assignment for Mini PCI Express Bus / SYNC Connector (Bootstart), X1/X2</i> , page 158.
	Transmission Rate	33 MHz
	Data Access	DPM or DMA* (Direct Memory Access); *CIFX 90E-DP\F from Hardware Revision A, CIFX 90E-DP\MR\F from Hardware Revision B, CIFX 90E-DP\NHS\F, CIFX 90E-DP\ET\F and CIFX 90E-DP\MR\ET\F from Hardware Revision 1
	Width for the data access to the Dual-Port Memory (DPM)	32-Bit
PROFIBUS Communication	Supported communication standard/ protocol (determined by the loaded firmware)	PROFIBUS DP Master, PROFIBUS DP Slave, PROFIBUS MPI Device
PROFIBUS interface	Transmission Rate	9,6 kBit/s, 19,2 kBit/s, 31,25 kBit/s, 45,45 kBit/s, 93,75 kBit/s, 187,5 kBit/s, 500 kBit/s, 1,5 MBit/s, 3 MBit/s, 6 MBit/s, 12 MBit/s
	Interface Type	RS 485, refer to section <i>PROFIBUS Interface</i> page 141.
	PROFIBUS detached Network Interface	AIFX-DP, refer to section <i>AIFX-DP</i> page 220. Important! Operating the PC card CIFX 90E-DP\F (all variants ‚NHS‘, ‚ET‘ or ‚MR‘) requires proper connection of the PROFIBUS detached network interface (AIFX-DP) to the basic card!
	Connector AIFX-DP	Cable Connector Fieldbus X3 (JST 10FMN-BMT-A-TF(LF)(SN), Pitch 1,0 mm)
Display	LED Display	SYS System Status LED
		For LEDs at AIFX-DP, refer to section <i>AIFX-DP</i> page 220.
Power supply	Supply Voltage	+3.3 V dc $\pm 5\%$, refer to section <i>Power Supply and Host Interface</i> on page 67. <i>Important!</i> For all PC cards cifX Mini PCI Express, the increase of the supply voltage from 0V to 3.3V must last longer than 180 μ s.
	Current consumption at 3.3 V	600 mA (maximum)

CIFX 90E-DP\F and Variants	Parameter	Value		
	Connector	Via Mini PCI Express Bus		
Environmental Conditions	Operating temperature range*	CIFX 90E-DP\ET\F, CIFX 90E-DP\MR\ET\F	CIFX 90E-DP\F, CIFX 90E-DP\NHS\F, CIFX 90E-DP\MR\F	CIFX 90E-DP\NHS\F
		-20 °C ... +70 °C	0 °C ... +55 °C	0 °C ... +45 °C
	*Air flow during measurement	0,5 m/s	0,5 m/s	0,0m/s
	Storage temperature range	-40 °C ... +85 °C		
	Humidity	10 ... 95% relative humidity, no condensation permitted		
	Environment	For UL compliant usage: The device must be used in a pollution degree 2 environment.		
Device	Dimensions (L x W x H)	CIFX 90E-DP\F ^{1,2} , CIFX 90E-DP\MR\F ²	51 x 30,2 +/- 0,1 x 11 mm	
		CIFX 90E-DP\NHS\F	51 x 30,2 +/- 0,1 x 10,8 mm	
		CIFX 90E-DP\ET\F, CIFX 90E-DP\MR\ET\F	51 x 30,2 +/- 0,1 x 12,5 mm	
		² Beginning with hardware revision A: 51 x 30,2 mm + 0,1 / - 0,1 mm x 11 mm; [W = 30,1mm ... 30,3 mm: The printed circuit board (PCB) has become wider on the right side by 0.1 mm ... 0.3 mm, thus deviating from the norm]. ¹ For hardware revision 9: 51 x 30,2 x 11 mm; [W = 30,2 mm: The printed circuit board (PCB) has become wider on the right side by 0.2 mm, thus deviating from the norm]. For further details on the element heights refer to section <i>Notes on the Card Height - PC Card cifX Mini PCI and Mini PCIe</i> on page 64.		
	Mounting/Installation	PCI Express Mini System Connector (3.3 V), X1/X2 ¹¹ = One Lane, refer to section <i>Slot for the PC Cards cifX Compact PCI, Mini PCI, Mini PCIe, PCI-104</i> , page 63.		
RoHS	Yes			
Compliance with EMC	CE Sign	Yes		
	UKCA Sign	Yes		
	Emission	EN 55011+ A1, CISPR 11, Class A / BS EN 55011+ A1, CISPR 11, Class A (Radio disturbance characteristics - Limits and methods of measurement)		
	Immunity	EN 61000-4-2 / BS EN 61000-4-2 (Electrostatic discharge test) EN 61000-4-3 + A1 + A2 / BS EN 61000-4-3 + A1 + A2 (Radiated, radio-frequency, electromagnetic field test) EN 61000-4-4 + A1 / BS EN 61000-4-4 + A1 (Burst Electrical fast transients/burst test) EN 61000-4-5 / BS EN 61000-4-5 (Surge test) EN 61000-4-6 / BS EN 61000-4-6 (to conducted disturbances, induced by radio- frequency fields) EN 61000-4-8 / BS EN 61000-4-8 (power frequency magnetic field test) EN 61000-6-2 + B1 / BS EN 61000-6-2 + B1 (for industrial environments)		
UL Certification	The device CIFX 90E-DP\F is	UL-File-Nr. E221530		

¹¹ X1, X2 corresponds to the Hilscher convention for „interface“ on the top or the bottom side of the PC Card cifX.

CIFX 90E-DP\F and Variants	Parameter	Value
	certified according to UL 508	
Configuration	Configuration Software Master and Slave	SYCON.net
	Configuration Software Slave	netX Configuration Tool

Table 134: Technical Data CIFX 90E-DP\F, CIFX 90E-DP\NHS\F, CIFX 90E-DP\ET\F, CIFX 90E-DP\MR\F, CIFX 90E-DP\MR\ET\F

9.1.12 CIFX 90E-CO\F and Variants

CIFX 90E-CO\F and Variants	Parameter	Value	
Part	Name, Part No.	CIFX 90E-CO\F	1291.500
		CIFX 90E-CO\NHS\F	1291.508
		CIFX 90E-CO\ET\F	1291.504
		CIFX 90E-CO\MR\F	1291.502
		CIFX 90E-CO\MR\ET\F	1291.506
	Description	PC Card cifX Mini PCI Express CANopen Master or Slave (and variants ,NHS' =no heat sink, with enlarged temperature range ,ET' and/or additional MRAM ,MR') composed of: - Basic card CIFX 90E, CIFX 90E\NHS, CIFX 90E\ET, CIFX 90E\MR or CIFX 90E\MR\ET with cable connector Fieldbus X3 and - CANopen detached network interface (AIFX-CO). Note: The device height and the power input of the PC Card cifX Mini PCI Express CIFX 90E-CO\F, CIFX 90E-CO\NHS\F, CIFX 90E-CO\ET\F, CIFX 90E-CO\MR\F and CIFX 90E-CO\MR\ET\F do not comply with the standard specifications.	
Function	Communication Interface with Mini PCI Express and CANopen interface		
Communication Controller	Type	netX 100 processor	
Integrated Memory	RAM	8 MB SDRAM	
	FLASH	4 MB serial Flash EPROM	
	Size of the Dual-Port Memory	64 KByte	
	MRAM (only CIFX 90E-CO\MR\F and CIFX 90E-CO\MR\ET\F)	128Kbyte (= 64K Words); Note: Using the cifX Device Driver (from Version 1.1.1.0) access to this memory is possible and it can be used as a remanent memory.	
System Interface	Bus Type	Mini PCI Express One Lane Port, according to [bus spec 2] and [bus spec 6], refer to section <i>Overview</i> , page 155 and <i>Pin Assignment for Mini PCI Express Bus / SYNC Connector (Bootstart)</i> , X1/X2, page 158.	
	Transmission Rate	33 MHz	
	Data Access	DPM or DMA* (Direct Memory Access); *CIFX 90E-CO\F from Hardware Revision A, CIFX 90E-CO\MR\F from Hardware Revision B, CIFX 90E-CO\NHS\F, CIFX 90E-CO\ET\F and CIFX 90E-CO\MR\ET\F from Hardware Revision 1	
	Width for the data access to the Dual-Port Memory (DPM)	32-Bit	
CANopen Communication	Supported communication standard/ protocol (determined by the loaded firmware)	CANopen Master, CANopen Slave	
CANopen interface	Transmission Rate	10 kBit/s, 20 kBit/s, 50 kBit/s, 100 kBit/s, 125 kBit/s, 250 kBit/s, 500 kBit/s, 800 kBit/s, 1 MBit/s	
	Interface Type	ISO-11898, refer to section <i>CANopen Interface</i> , page 141.	

CIFX 90E-COF and Variants	Parameter	Value		
	CANopen detached Network Interface	AIFX-CO, refer to section <i>AIFX-CO</i> , page 221. Important! Operating the PC card CIFX 90E-COF (all variants 'NHS', 'ET' or 'MR') requires proper connection of the CANopen detached network interface (AIFX-CO) to the basic card!		
	Connector AIFX-CO	Cable Connector Fieldbus X3 (JST 10FMN-BMT-A-TF(LF)(SN), Pitch 1,0 mm)		
Display	LED Display	SYS System Status LED		
		For LEDs at AIFX-CO, refer to section <i>AIFX-CO</i> , p. 221.		
Power supply	Supply Voltage	+3.3 V dc ±5 %, refer to section <i>Power Supply and Host Interface</i> on page 67. <i>Important!</i> For all PC cards cifX Mini PCI Express, the increase of the supply voltage from 0V to 3.3V must last longer than 180 µs.		
	Current consumption at 3.3 V	600 mA (maximum)		
	Connector	Via Mini PCI Express Bus		
Environmental Conditions	Operating temperature range*	CIFX 90E-CO\ET\F, CIFX 90E-CO\MR\ET\F	CIFX 90E-CO\F, CIFX 90E-CO\MR\F, CIFX 90E-CO\NHS\F	CIFX 90E-CO\NHS\F
		-20 °C ... +70 °C	0 °C ... +55 °C	0 °C ... +45 °C
	*Air flow during measurement	0,5 m/s	0,5 m/s	0,0m/s
	Storage temperature range	-40 °C ... +85 °C		
	Humidity	10 ... 95% relative humidity, no condensation permitted		
	Environment	For UL compliant usage: The device must be used in a pollution degree 2 environment.		
Device	Dimensions (L x W x H)	CIFX 90E-CO\F ^{1,2} , CIFX 90E-CO\MR\F ²	51 x 30,2 +/- 0,1 x 11 mm	
		CIFX 90E-CO\NHS\F	51 x 30,2 +/- 0,1 x 10,8 mm	
		CIFX 90E-CO\ET\F, CIFX 90E-CO\MR\ET\F	51 x 30,2 +/- 0,1 x 12,5 mm	
	² Beginning with hardware revision A: 51 x 30,2 mm + 0,1 / - 0,1 mm x 11 mm; [W = 30,1mm ... 30,3 mm: The printed circuit board (PCB) has become wider on the right side by 0.1 mm ... 0.3 mm, thus deviating from the norm]. ¹ For hardware revision 9: 51 x 30,2 x 11 mm; [W = 30,2 mm: The printed circuit board (PCB) has become wider on the right side by 0.2 mm, thus deviating from the norm]. For further details on the element heights refer to section <i>Notes on the Card Height - PC Card cifX Mini PCI and Mini PCIe</i> on page 64.			
	Mounting/Installation	PCI Express Mini System Connector (3.3 V), X1/X2 ¹² = One Lane, refer to section <i>Slot for the PC Cards cifX Compact PCI, Mini PCI, Mini PCIe, PCI-104</i> , page 63.		
RoHS	Yes			
Compliance with EMC	CE Sign	Yes		
	UKCA Sign	Yes		
	Emission	EN 55011+ A1, CISPR 11, Class A / BS EN 55011+ A1, CISPR 11, Class A (Radio disturbance characteristics - Limits and methods of measurement)		
	Immunity	EN 61000-4-2 / BS EN 61000-4-2		

¹² X1, X2 corresponds to the Hilscher convention for „interface“ on the top or the bottom side of the PC Card cifX.

CIFX 90E-COF and Variants	Parameter	Value
		(Electrostatic discharge test) EN 61000-4-3 + A1 + A2 / BS EN 61000-4-3 + A1 + A2 (Radiated, radio-frequency, electromagnetic field test) EN 61000-4-4 + A1 / BS EN 61000-4-4 + A1 (Burst Electrical fast transients/burst test) EN 61000-4-5 / BS EN 61000-4-5 (Surge test) EN 61000-4-6 / BS EN 61000-4-6 (to conducted disturbances, induced by radio- frequency fields) EN 61000-4-8 / BS EN 61000-4-8 (power frequency magnetic field test) EN 61000-6-2 + B1 / BS EN 61000-6-2 + B1 (for industrial environments)
UL Certification	The device CIFX 90E-COF is certified according to UL 508	UL-File-Nr. E221530
Configuration	Configuration Software Master and Slave	SYCON.net
	Configuration Software Slave	netX Configuration Tool

Table 135: Technical Data CIFX 90E-COF, CIFX 90E-COWHS\F, CIFX 90E-CO\ET\F, CIFX 90E-COMR\F, CIFX 90E-COMR\ET\F

9.1.13 CIFX 90E-DN\F and Variants

CIFX 90E-DN\F and Variants	Parameter	Value	
Part	Name, Part No.	CIFX 90E-DN\F	1291.510
		CIFX 90E-DN\NHS\F	1291.518
		CIFX 90E-DN\ET\F	1291.514
		CIFX 90E-DN\MR\F	1291.512
		CIFX 90E-DN\MR\ET\F	1291.516
		PC Card cifX Mini PCI Express DeviceNet Master or Slave (and variants ,NHS' =no heat sink, with enlarged temperature range ,ET' and/or additional MRAM ,MR') composed of: - Basic card CIFX 90E, CIFX 90E\NHS, CIFX 90E\ET, CIFX 90E\MR or CIFX 90E\MR\ET with cable connector Fieldbus X3 and - DeviceNet detached network interface (AIFX-DN). Note: The device height and the power input of the PC Card cifX Mini PCI Express CIFX 90E-DN\F, CIFX 90E-DN\NHS\F, CIFX 90E-DN\ET\F, CIFX 90E-DN\MR\F and CIFX 90E-DN\MR\ET\F do not comply with the standard specifications.	
Function	Communication Interface with Mini PCI Express and DeviceNet interface		
Communication Controller	Type	netX 100 processor	
Integrated Memory	RAM	8 MB SDRAM	
	FLASH	4 MB serial Flash EPROM	
	Size of the Dual-Port Memory	64 KByte	
	MRAM (only CIFX 90E-DN\MR\F and CIFX 90E-DN\MR\ET\F)	128Kbyte (= 64K Words); Note: Using the cifX Device Driver (from Version 1.1.1.0) access to this memory is possible and it can be used as a remanent memory.	
System Interface	Bus Type	Mini PCI Express One Lane Port, according to [bus spec 2] and [bus spec 6], refer to section <i>Overview</i> , page 155 and <i>Pin Assignment for Mini PCI Express Bus / SYNC Connector (Bootstart)</i> , X1/X2, page 158.	

CIFX 90E-DNF and Variants	Parameter	Value		
	Transmission Rate	33 MHz		
	Data Access	DPM or DMA* (Direct Memory Access); *CIFX 90E-DNF from Hardware Revision A, CIFX 90E-DN\MR\F from Hardware Revision B, CIFX 90E-DN\NHS\F, CIFX 90E-DN\ET\F and CIFX 90E-DN\MR\ET\F from Hardware Revision 1		
	Width for the data access to the Dual-Port Memory (DPM)	32-Bit		
DeviceNet Communication	Supported communication standard/ protocol (determined by the loaded firmware)	DeviceNet Master, DeviceNet Slave		
DeviceNet interface	Transmission Rate	125 kBit/s, 250 kBit/s, 500 kBit/s		
	Interface Type	ISO-11898 according to DeviceNet specification, refer to section <i>DeviceNet Interface</i> , page 142.		
	DeviceNet detached Network Interface	AIFX-DN, refer to section <i>AIFX-DN</i> , page 222. Important! Operating the PC card CIFX 90E-DNF (all variants 'NHS', 'ET' or 'MR') requires proper connection of the DeviceNet detached network interface (AIFX-DN) to the basic card!		
	Connector AIFX-DN	Cable Connector Fieldbus X3 (JST 10FMN-BMT-A-TF(LF)(SN), Pitch 1,0 mm)		
Display	LED Display	SYS System Status LED		
		For LED at AIFX-DN, refer to section <i>AIFX-DN</i> , p. 222.		
Power supply	Supply Voltage	+3.3 V dc ±5 %, refer to section <i>Power Supply and Host Interface</i> on page 67. <i>Important!</i> For all PC cards cifX Mini PCI Express, the increase of the supply voltage from 0V to 3.3V must last longer than 180 µs.		
	Current consumption at 3.3 V	600 mA (maximum)		
	Connector	Via Mini PCI Express Bus		
Environmental Conditions	Operating temperature range*	CIFX 90E-DN\ET\F, CIFX 90E-DN\MR\ET\F	CIFX 90E-DNF, CIFX 90E-DN\NHS\F, CIFX 90E-DN\MR\F	CIFX 90E-DN\NHS\F
		-20 °C ... +70 °C	0 °C ... +55 °C	0 °C ... +45 °C
	*Air flow during measurement	0,5 m/s	0,5 m/s	0,0m/s
	Storage temperature range	-40 °C ... +85 °C		
	Humidity	10 ... 95% relative humidity, no condensation permitted		
	Environment	For UL compliant usage: The device must be used in a pollution degree 2 environment.		
Device	Dimensions (L x W x H)	CIFX 90E-DNF ^{1,2} , CIFX 90E-DN\MR\F ²	51 x 30,2 +/- 0,1 x 11 mm	
		CIFX 90E-DN\NHS\F	51 x 30,2 +/- 0,1 x 10,8 mm	
		CIFX 90E-DN\ET\F, CIFX 90E-DN\MR\ET\F	51 x 30,2 +/- 0,1 x 12,5 mm	
	² Beginning with hardware revision A: 51 x 30,2 mm + 0,1 / - 0,1 mm x 11 mm; [W = 30,1mm ... 30,3 mm: The printed circuit board (PCB) has become wider on the right side by 0.1 mm ... 0.3 mm, thus deviating from the norm]. ¹ For hardware revision 9: 51 x 30,2 x 11 mm; [W = 30,2 mm: The printed circuit board (PCB) has become wider on the right side by 0.2 mm, thus deviating from the norm]. For further details on the element heights refer to section <i>Notes on the Card Height - PC Card cifX Mini PCI and Mini PCIe</i> on page 64.			

CIFX 90E-DNF and Variants	Parameter	Value
	Mounting/Installation	PCI Express Mini System Connector (3.3 V), X1/X2 ¹³ = One Lane, refer to section <i>Slot for the PC Cards cifX Compact PCI, Mini PCI, Mini PCIe, PCI-104</i> , page 63.
	RoHS	Yes
Compliance with EMC	CE Sign	Yes
	UKCA Sign	Yes
	Emission	EN 55011+ A1, CISPR 11, Class A / BS EN 55011+ A1, CISPR 11, Class A (Radio disturbance characteristics - Limits and methods of measurement)
	Immunity	EN 61000-4-2 / BS EN 61000-4-2 (Electrostatic discharge test) EN 61000-4-3 + A1 + A2 / BS EN 61000-4-3 + A1 + A2 (Radiated, radio-frequency, electromagnetic field test) EN 61000-4-4 + A1 / BS EN 61000-4-4 + A1 (Burst Electrical fast transients/burst test) EN 61000-4-5 / BS EN 61000-4-5 (Surge test) EN 61000-4-6 / BS EN 61000-4-6 (to conducted disturbances, induced by radio- frequency fields) EN 61000-4-8 / BS EN 61000-4-8 (power frequency magnetic field test) EN 61000-6-2 + B1 / BS EN 61000-6-2 + B1 (for industrial environments)
UL Certification	The device CIFX 90E-DNF is certified according to UL 508	UL-File-Nr. E221530
Configuration	Configuration Software Master and Slave	SYCON.net
	Configuration Software Slave	netX Configuration Tool

Table 136: Technical Data CIFX 90E-DNF, CIFX 90E-DNHS\F, CIFX 90E-DNET\F, CIFX 90E-DNMR\F, CIFX 90E-DNMR\ET\F

9.1.14 CIFX 90E-CC\NHS\F, CIFX 90E-CC\ET\F, CIFX 90E-CC\MR\ET\F

CIFX 90E-CC\NHS\F, CIFX 90E-CC\ET\F, CIFX 90E-CC\MR\ET\F	Parameter	Value
Part	Name, Part No.	CIFX 90E-CC\NHS\F 1291.748
		CIFX 90E-CC\ET\F 1291.744
		CIFX 90E-CC\MR\ET\F 1291.746
	Description	PC Card cifX Mini PCI Express CC-Link Slave (as variants ‚NHS‘ =no heat sink, with enlarged temperature range ‚ET‘ and/or additional MRAM ‚MR‘) composed of: - Basic card CIFX 90E\NHS, CIFX 90E\ET or CIFX 90E\MR\ET with cable connector Fieldbus X3 and - CC-Link detached network interface (AIFX-CC). Note: The device height and the power input of the PC Card cifX Mini PCI Express CIFX 90E-CC\NHS\F, CIFX 90E-CC\ET\F and CIFX 90E-CC\MR\ET\F do not comply with the standard specifications.
Function	Communication Interface with Mini PCI Express and CC-Link interface	
Communication Controller	Type	netX 100 processor

¹³ X1, X2 corresponds to the Hilscher convention for „interface“ on the top or the bottom side of the PC Card cifX.

CIFX 90E-CC\NHS\F, CIFX 90E-CC\ETF, CIFX 90E-CC\MR\ETF	Parameter	Value		
Integrated Memory	RAM	8 MB SDRAM		
	FLASH	4 MB serial Flash EPROM		
	Size of the Dual-Port Memory	64 KByte		
	MRAM (only CIFX 90E-DN\MR\F and CIFX 90E-DN\MR\ETF)	128Kbyte (= 64K Words); Note: Using the cifX Device Driver (from Version 1.1.1.0) access to this memory is possible and it can be used as a remanent memory.		
System Interface	Bus Type	Mini PCI Express One Lane Port, according to [bus spec 2] and [bus spec 6], refer to section <i>Overview</i> , page 155 and <i>Pin Assignment for Mini PCI Express Bus / SYNC Connector (Bootstart), X1/X2</i> , page 158.		
	Transmission Rate	33 MHz		
	Data Access	DPM or DMA* (Direct Memory Access); *CIFX 90E-CC\NHS\F, CIFX 90E-CC\ETF and CIFX 90E-CC\MR\ETF from Hardware Revision 1		
	Width for the data access to the Dual-Port Memory (DPM)	32-Bit		
CC-Link Communication	Supported communication standard/ protocol (determined by the loaded firmware)	CC-Link Slave		
CC-Link interface	Transmission Rate	156 kBit/s, 625 kBit/s, 2500 kBit/s, 5 MBit/s, 10 MBit/s		
	Interface Type	RS-485, refer to section <i>CC-Link Interface</i> , page 142.		
	CC-Link detached Network Interface	AIFX-CC, refer to section <i>AIFX-CC</i> , page 223. Important! Operating the PC card CIFX 90E-CC\ETF and. CIFX 90E-CC\MR\ETF requires proper connection of the CC-Link detached network interface (AIFX-CC) to the basic card!		
	Connector AIFX-CC	Cable Connector Fieldbus X3 (JST 10FMN-BMT-A-TF(LF)(SN), Pitch 1,0 mm)		
Display	LED Display	SYS System Status LED		
		For LEDs at AIFX-CC, refer to section <i>AIFX-CC</i> , p. 223.		
Power supply	Supply Voltage	+3.3 V dc $\pm 5\%$, refer to section <i>Power Supply and Host Interface</i> on page 67. <i>Important!</i> For all PC cards cifX Mini PCI Express, the increase of the supply voltage from 0V to 3.3V must last longer than 180 μ s.		
	Current consumption at 3.3 V	600 mA (maximum)		
	Connector	Via Mini PCI Express Bus		
Environmental Conditions	Operating temperature range*	CIFX 90E-CC\ETF, CIFX 90E-CC\MR\ETF	CIFX 90E-CC\NHS\F	CIFX 90E-CC\NHS\F
		0 °C ... +60 °C	0 °C ... +55 °C	0 °C ... +45 °C
	*Air flow during measurment	0,5 m/s	0,5 m/s	0,0 m/s
	Storage temperature range	-40 °C ... +85 °C		
	Humidity	10 ... 95% relative humidity, no condensation permitted		
Device	Dimensions (L x W x H)	CIFX 90E-CC\NHS\F	51 x 30,2 +/- 0,1 x 10,8 mm	
		CIFX 90E-CC\ETF, CIFX 90E-CC\MR\ETF	51 x 30,2 +/- 0,1 x 12,5 mm	
	For details on the element hights refer to section <i>Notes on the Card Height - PC Card cifX Mini PCI and Mini PCIe</i> on page 64.			

CIFX 90E-CC\NHS\F, CIFX 90E-CC\ET\F, CIFX 90E-CC\MR\ET\F	Parameter	Value
	Mounting/Installation	PCI Express Mini System Connector (3.3 V), X1/X2 ¹⁴ = One Lane, refer to section <i>Slot for the PC Cards cifX Compact PCI, Mini PCI, Mini PCIe, PCI-104</i> , page 63.
	RoHS	Yes
Compliance with EMC	CE Sign	Yes
	UKCA Sign	Yes
	Emission	EN 55011+ A1, CISPR 11, Class A / BS EN 55011+ A1, CISPR 11, Class A (Radio disturbance characteristics - Limits and methods of measurement)
	Immunity	EN 61000-4-2 / BS EN 61000-4-2 (Electrostatic discharge test) EN 61000-4-3 + A1 + A2 / BS EN 61000-4-3 + A1 + A2 (Radiated, radio-frequency, electromagnetic field test) EN 61000-4-4 + A1 / BS EN 61000-4-4 + A1 (Burst Electrical fast transients/burst test) EN 61000-4-5 / BS EN 61000-4-5 (Surge test) EN 61000-4-6 / BS EN 61000-4-6 (to conducted disturbances, induced by radio- frequency fields) EN 61000-4-8 / BS EN 61000-4-8 (power frequency magnetic field test) EN 61000-6-2 + B1 / BS EN 61000-6-2 + B1 (for industrial environments)
Configuration	Configuration Software	SYCON.net or netX Configuration Tool

Table 137: Technical Data CIFX 90E-CC\NHS\F, CIFX 90E-CC\ET\F, CIFX 90E-CC\MR\ET\F

¹⁴ X1, X2 corresponds to the Hilscher convention for „interface“ on the top or the bottom side of the PC Card cifX.

9.1.15 CIFX 90E-2DP\ET\F, CIFX 90E-2DP\MR\ET\F

CIFX 90E-2DP\ET\F, CIFX 90E-2DP\MR\ET\F	Parameter	Value	
Part	Name, Part No.	CIFX 90E-2DP\ET\F	1293.414
		CIFX 90E-2DP\MR\ET\F	1293.416
	Description	PC Card cifX Minfsddi PCI Express with 2 channels PROFIBUS DP Master or Slave (as variants with additional MRAM ,MR' and enlarged temperature range ,ET') composed of:sdf - Basic card CIFX 9sfd0E-2FB\ET or CIFX 90E-2FB\MR\ET with cable condsnector Fieldbus X3 and X4, - PROFIBUS detached network interface (AIFX-DP). Note: The device height and the power input of the PC Card Mini PCI Express CIFX 90E-2DP\ET\F and CIFX 90E-2DP\MR\ET\F do not comply with the standard specifications.	
Function	Communication Interface with Mini PCI Express and 2 x PROFIBUS interface		
Communication Controller	Type	netX 100 processor	
Integrated Memory	RAM	8 MB SDRAM	
	FLASH	4 MB serial Flash EPROM	
	Size of the Dual-Port Memory	64 KByte	
	MRAM (only CIFX 90E-2DP\MR\ET\F F)	128Kbyte (= 64K Words); Note: Using the cifX Device Driver (from Version 1.1.1.0) access to this memory is possible and it can be used as a remanent memory.	
System Interface	Bus Type	Mini PCI Express One Lane Port, according to [bus spec 2] and [bus spec 6], refer to section <i>Overview</i> , page 155 and <i>Pin Assignment for Mini PCI Express Bus / SYNC Connector (Bootstart)</i> , X1/X2, page 158.	
	Transmission Rate	33 MHz	
	Data Access	DPM or DMA (Direct Memory Access)	
	Width for the data access to the Dual-Port Memory (DPM)	32-Bit	
PROFIBUS Communication	Supported communication standard/ protocol (determined by the loaded firmware)	PROFIBUS DP Master, PROFIBUS DP Slave	
PROFIBUS interface	Transmission Rate	9,6 kBit/s, 19,2 kBit/s, 31,25 kBit/s, 45,45 kBit/s, 93,75 kBit/s, 187,5 kBit/s, 500 kBit/s, 1,5 MBit/s, 3 MBit/s, 6 MBit/s, 12 MBit/s	
	Interface Type	RS 485, refer to section <i>PROFIBUS Interface</i> page 141.	
	PROFIBUS detached Network Interface	AIFX-DP, refer to section <i>AIFX-DP</i> page 220. Important! Operating the PC card CIFX 90E-2DP\ET\F or CIFX 90E-2DP\MR\ET\F requires proper connection of both PROFIBUS detached network interfaces (AIFX-DP) to the basic card!	
	Connector AIFX-DP	Cable Connector Fieldbus X3 and X4 (JST 10FMN-BMT-A-TF(LF)(SN), Pitch 1,0 mm)	
Display	LED Display	SYS System Status LED	
		For LEDs at AIFX-DP, refer to section <i>AIFX-DP</i> page 220.	
Power supply	Supply Voltage	+3.3 V dc $\pm 5\%$, refer to section <i>Power Supply and Host Interface</i> on page 67. <i>Important!</i> For all PC cards cifX Mini PCI Express, the increase of the supply voltage from 0V to 3.3V must last longer than 180 μ s.	
	Current consumption at 3.3 V	800 mA (maximum)	
	Connector	Via Mini PCI Express Bus	
Environmental		CIFX 90E-2DP\ET\F, CIFX 90E-2DP\MR\ET\F	

CIFX 90E-2DP\ET\F, CIFX 90E-2DP\MR\ET\F	Parameter	Value
Conditions	Operating temperature range*	-20 °C ... +70 °C
	Storage temperature range	-40 °C ... +85 °C
	*Air flow during measurement	0,5m/s
	Humidity	10 ... 95% relative humidity, no condensation permitted
Device	Dimensions (L x W x H)	CIFX 90E-2DP\ET\F, CIFX 90E-2DP\MR\ET\F
		51 x 30,2 +/- 0,1 x 12,5 mm
		For details on the element heights refer to section <i>Notes on the Card Height - PC Card cifX Mini PCI and Mini PCIe</i> on page 64.
	Mounting/Installation	PCI Express Mini System Connector (3.3 V), X1/X2 ¹⁵ = One Lane, refer to section <i>Slot for the PC Cards cifX Compact PCI, Mini PCI, Mini PCIe, PCI-104</i> , page 63.
	RoHS	Yes
Compliance with EMC	CE Sign	Yes
	UKCA Sign	Yes
	Emission	EN 55011+ A1, CISPR 11, Class A / BS EN 55011+ A1, CISPR 11, Class A (Radio disturbance characteristics - Limits and methods of measurement)
	Immunity	EN 61000-4-2 / BS EN 61000-4-2 (Electrostatic discharge test) EN 61000-4-3 + A1 + A2 / BS EN 61000-4-3 + A1 + A2 (Radiated, radio-frequency, electromagnetic field test) EN 61000-4-4 + A1 / BS EN 61000-4-4 + A1 (Burst Electrical fast transients/burst test) EN 61000-4-5 / BS EN 61000-4-5 (Surge test) EN 61000-4-6 / BS EN 61000-4-6 (to conducted disturbances, induced by radio- frequency fields) EN 61000-4-8 / BS EN 61000-4-8 (power frequency magnetic field test) EN 61000-6-2 + B1 / BS EN 61000-6-2 + B1 (for industrial environments)
Configuration	Configuration Software Master and Slave	SYCON.net
	Configuration Software Slave	netX Configuration Tool

Table 138: Technical Data CIFX 90E-2DP\ET\F, CIFX 90E-2DP\MR\ET\F

9.1.16 CIFX 90E-2DP\CO\ET\F, CIFX 90E-2DP\COMR\ET\F

CIFX 90E-2DP\CO\ET\F, CIFX 90E-2DP\COMR\ET\F	Parameter	Value
Part	Name, Part No.	CIFX 90E-2DP\CO\ET\F 1293.474
		CIFX 90E-2DP\COMR\ET\F 1293.476
	Description	PC Card cifX Mini PCI Express with 2 channels - Channel X1: PROFIBUS DP Master or Slave, Channel X2: CANopen Master or Slave (as variants with additional MRAM ,MR' and enlarged temperature range ,ET') composed of: - Basic card CIFX 90E-2FB\ET or CIFX 90E-2FB\MR\ET with cable connector Fieldbus X3 and X4, - PROFIBUS assembly interface (AIFX-DP) and

¹⁵ X1, X2 corresponds to the Hilscher convention for „interface“ on the top or the bottom side of the PC Card cifX.

CIFX 90E-2DP\CO\ET\F, CIFX 90E-2DP\CO\MR\ET\F	Parameter	Value
		- CANopen assembly interface (AIFX-CO). Note: The device height and the power input of the PC Card Mini PCI Express CIFX 90E-2DP\CO\ET\F and CIFX 90E-2DP\CO\MR\ET\F do not comply with the standard specifications.
	Function	Communication Interface with Mini PCI Express, 1 x PROFIBUS interface and 1x CANopen interface
Communication Controller	Type	netX 100 processor
Integrated Memory	RAM	8 MB SDRAM
	FLASH	4 MB serial Flash EPROM
	Size of the Dual-Port Memory	64 KByte
	MRAM (only CIFX 90E-2DP\CO\MR\ET\F)	128Kbyte (= 64K Words); Note: Using the cifX Device Driver (from Version 1.1.1.0) access to this memory is possible and it can be used as a remanent memory.
System Interface	Bus Type	Mini PCI Express One Lane Port, according to [bus spec 2] and [bus spec 6], refer to section <i>Overview</i> , page 155 and <i>Pin Assignment for Mini PCI Express Bus / SYNC Connector (Bootstart), X1/X2</i> , page 158.
	Transmission Rate	33 MHz
	Data Access	DPM or DMA (Direct Memory Access)
	Width for the data access to the Dual-Port Memory (DPM)	32-Bit
PROFIBUS Communication	Supported communication standard/ protocol (determined by the loaded firmware)	PROFIBUS DP Master, PROFIBUS DP Slave
PROFIBUS interface	Transmission Rate	9,6 kBit/s, 19,2 kBit/s, 31,25 kBit/s, 45,45 kBit/s, 93,75 kBit/s, 187,5 kBit/s, 500 kBit/s, 1,5 MBit/s, 3 MBit/s, 6 MBit/s, 12 MBit/s
	Interface Type	RS 485, refer to section <i>PROFIBUS Interface</i> page 141.
	PROFIBUS Assembly Interface	AIFX-DP, refer to section <i>AIFX-DP</i> page 220. Important! Operating the PC card CIFX 90E-2DP\CO\ET\F or CIFX 90E-2DP\CO\MR\ET\F requires proper connection of the PROFIBUS assembly interface (AIFX-DP) and of the CANopen assembly interface (AIFX-CO) to the basic card!
	Connector AIFX-DP	Cable Connector Fieldbus X3 (JST 10FMN-BMT-A-TF(LF)(SN), Pitch 1,0 mm)
CANopen Communication	Supported communication standard/ protocol (determined by the loaded firmware)	CANopen Master, CANopen Slave
CANopen Interface	Transmission rate	10 kBit/s, 20 kBit/s, 50 kBit/s, 100 kBit/s, 125 kBit/s, 250 kBit/s, 500 kBit/s, 800 kBit/s, 1 MBit/s
	Interface Type	ISO-11898, refer to section <i>CANopen Interface</i> , page 141.
	CANopen Assembly Interface	AIFX-CO, refer to section <i>AIFX-CO</i> , page 221. Important! Operating the PC card CIFX 90E-2DP\CO\ET\F or CIFX 90E-2DP\CO\MR\ET\F requires proper connection of the PROFIBUS assembly interface (AIFX-DP) and of the CANopen assembly interface (AIFX-CO) to the basic card!
	Connector AIFX-CO	Connector Fieldbus X4 (JST 10FMN-SMT-A-TF(LF)(SN), Pitch 1,0 mm)
Display	LED Display	SYS System Status LED
		For the LEDs at AIFX-DP at channel X1, refer to section <i>AIFX-DP</i> page 220. For the LEDs at AIFX-CO at channel X2, refer to section <i>AIFX-CO</i> , page 221.

CIFX 90E-2DP\CO\ET\F, CIFX 90E-2DP\COMR\ET\F	Parameter	Value
Power supply	Supply Voltage	+3.3 V dc $\pm 5\%$, refer to section <i>Power Supply and Host Interface</i> on page 67. <i>Important!</i> For all PC cards cifX Mini PCI Express, the increase of the supply voltage from 0V to 3.3V must last longer than 180 μ s.
	Current consumption at 3.3 V	800 mA (maximum)
	Connector	Via Mini PCI Express Bus
Environmental Conditions	Operating temperature range*	CIFX 90E-2DP\CO\ET\F, CIFX 90E-2DP\COMR\ET\F -20 °C ... +70 °C
	Storage temperature range	-40 °C ... +85 °C
	*Air flow during measurement	0,5m/s
	Humidity	10 ... 95% relative humidity, no condensation permitted
	Dimensions (L x W x H)	CIFX 90E-2DP\CO\ET\F, CIFX 90E-2DP\COMR\ET\F 51 x 30,2 +/- 0,1 x 12,5 mm For details on the element heights refer to section <i>Notes on the Card Height - PC Card cifX Mini PCI and Mini PCIe</i> on page 64.
Device	Mounting/Installation	PCI Express Mini System Connector (3.3 V), X1/X2 ¹⁶ = One Lane, refer to section <i>Slot for the PC Cards cifX Compact PCI, Mini PCI, Mini PCIe, PCI-104</i> , page 63.
	RoHS	Yes
Compliance with EMC	CE Sign	Yes
	UKCA Sign	Yes
	Emission	EN 55011+ A1, CISPR 11, Class A / BS EN 55011+ A1, CISPR 11, Class A (Radio disturbance characteristics - Limits and methods of measurement)
	Immunity	EN 61000-4-2 / BS EN 61000-4-2 (Electrostatic discharge test) EN 61000-4-3 + A1 + A2 / BS EN 61000-4-3 + A1 + A2 (Radiated, radio-frequency, electromagnetic field test) EN 61000-4-4 + A1 / BS EN 61000-4-4 + A1 (Burst Electrical fast transients/burst test) EN 61000-4-5 / BS EN 61000-4-5 (Surge test) EN 61000-4-6 / BS EN 61000-4-6 (to conducted disturbances, induced by radio- frequency fields) EN 61000-4-8 / BS EN 61000-4-8 (power frequency magnetic field test) EN 61000-6-2 + B1 / BS EN 61000-6-2 + B1 (for industrial environments)
Configuration	Configuration Software Master and Slave	SYCON.net
	Configuration Software Slave	netX Configuration Tool

Table 139: Technical Data CIFX 90E-2DP\CO\ET\F, CIFX 90E-2DP\COMR\ET\F

9.1.17 CIFX 90E-2DP\DN\ET\F, CIFX 90E-2DP\DN\MR\ET\F

CIFX 90E-2DP\DN\ET\F, CIFX 90E-2DP\DN\MR\ET\F	Parameter	Value
Part	Name, Part No.	CIFX 90E-2DP\DN\ET\F 1293.484

¹⁶ X1, X2 corresponds to the Hilscher convention for „interface“ on the top or the bottom side of the PC Card cifX.

CIFX 90E-2DP\DN\NET\F, CIFX 90E-2DP\DN\MR\ET\F	Parameter	Value
		CIFX 90E-2DP\DN\MR\ET\F 1293.486
	Description	PC Card cifX Mini PCI Express with 2 channels - Channel X1: PROFIBUS DP Master or Slave, Channel X2: DeviceNet Master or Slave (as variants with additional MRAM ,MR' and enlarged temperature range ,ET') composed of: - Basic card CIFX 90E-2FB\ET or CIFX 90E-2FB\MR\ET with cable connector Fieldbus X3 and X4, - PROFIBUS detached network interface (AIFX-DP) and - DeviceNet detached network interface (AIFX-DN). Note: The device height and the power input of the PC Card Mini PCI Express CIFX 90E-2DP\DN\ET\F and CIFX 90E-2DP\DN\MR\ET\F do not comply with the standard specifications.
	Function	Communication Interface with Mini PCI Express, 1 x PROFIBUS interface and 1x DeviceNet interface
Communication Controller	Type	netX 100 processor
Integrated Memory	RAM	8 MB SDRAM
	FLASH	4 MB serial Flash EPROM
	Size of the Dual-Port Memory	64 KByte
	MRAM (only CIFX 90E-2DP\DN\MR\ET\F)	128Kbyte (= 64K Words); Note: Using the cifX Device Driver (from Version 1.1.1.0) access to this memory is possible and it can be used as a remanent memory.
System Interface	Bus Type	Mini PCI Express One Lane Port, according to [bus spec 2] and [bus spec 6], refer to section <i>Overview</i> , page 155 and <i>Pin Assignment for Mini PCI Express Bus / SYNC Connector (Bootstart), X1/X2</i> , page 158.
	Transmission Rate	33 MHz
	Data Access	DPM or DMA (Direct Memory Access)
	Width for the data access to the Dual-Port Memory (DPM)	32-Bit
PROFIBUS Communication	Supported communication standard/ protocol (determined by the loaded firmware)	PROFIBUS DP Master, PROFIBUS DP Slave
PROFIBUS interface	Transmission Rate	9,6 kBit/s, 19,2 kBit/s, 31,25 kBit/s, 45,45 kBit/s, 93,75 kBit/s, 187,5 kBit/s, 500 kBit/s, 1,5 MBit/s, 3 MBit/s, 6 MBit/s, 12 MBit/s
	Interface Type	RS 485, refer to section <i>PROFIBUS Interface</i> page 141.
	PROFIBUS detached Network Interface	AIFX-DP, refer to section <i>AIFX-DP</i> page 220. Important! Operating the PC card CIFX 90E-2DP\DN\ET\F or CIFX 90E-2DP\DN\MR\ET\F requires proper connection of the PROFIBUS detached network interface (AIFX-DP) and of the DeviceNet detached network interface (AIFX-DN) to the basic card!
	Connector AIFX-DP	Cable Connector Fieldbus X3 (JST 10FMN-BMT-A-TF(LF)(SN), Pitch 1,0 mm)
DeviceNet Communication	Supported communication standard/ protocol (determined by the loaded firmware)	DeviceNet Master, DeviceNet Slave
DeviceNet Interface	Transmission rate	125 kBit/s, 250 kBit/s, 500 kBit/s
	Interface Type	ISO-11898 according to DeviceNet specification, refer to section <i>DeviceNet Interface</i> , page 142
	DeviceNet detached Network Interface	AIFX-DN, refer to section <i>AIFX-DN</i> , page 222. Important! Operating the PC card CIFX 90E-2DP\DN\ET\F or CIFX 90E-2DP\DN\MR\ET\F requires proper connection of the PROFIBUS detached network interface (AIFX-DP) and of the DeviceNet detached network interface (AIFX-DN) to the basic

CIFX 90E-2DP\DN\ET\F, CIFX 90E-2DP\DN\MR\ET\F	Parameter	Value
		card!
	Connector AIFX-DN	Connector Fieldbus X4 (JST 10FMN-SMT-A-TF(LF)(SN), Pitch 1,0 mm)
Display	LED Display	SYS System Status LED For the LEDs at AIFX-DP at channel X1, refer to section <i>AIFX-DP</i> page 220. For the LEDs at AIFX-DN at channel X2, refer to section <i>AIFX-DN</i> , page 222.
Power supply	Supply Voltage	+3.3 V dc $\pm 5\%$, refer to section <i>Power Supply and Host Interface</i> on page 67. <i>Important!</i> For all PC cards cifX Mini PCI Express, the increase of the supply voltage from 0V to 3.3V must last longer than 180 μ s.
	Current consumption at 3.3 V	800 mA (maximum)
	Connector	Via Mini PCI Express Bus
Environmental Conditions		CIFX 90E-2DP\DN\ET\F, CIFX 90E-2DP\DN\MR\ET\F
	Operating temperature range*	-20 °C ... +70 °C
	Storage temperature range	-40 °C ... +85 °C
	*Air flow during measurement	0,5 m/s
Device		10 ... 95% relative humidity, no condensation permitted
	Dimensions (L x W x H)	CIFX 90E-2DP\DN\ET\F, CIFX 90E-2DP\DN\MR\ET\F
		51 x 30,2 +/- 0,1 x 12,5 mm For details on the element heights refer to section <i>Notes on the Card Height - PC Card cifX Mini PCI and Mini PCIe</i> on page 64.
	Mounting/Installation	PCI Express Mini System Connector (3.3 V), X1/X2 ¹⁷ = One Lane, refer to section <i>Slot for the PC Cards cifX Compact PCI, Mini PCI, Mini PCIe, PCI-104</i> , page 63.
RoHS	Yes	
Compliance with EMC	CE Sign	Yes
	UKCA Sign	Yes
	Emission	EN 55011+ A1, CISPR 11, Class A / BS EN 55011+ A1, CISPR 11, Class A (Radio disturbance characteristics - Limits and methods of measurement)
	Immunity	EN 61000-4-2 / BS EN 61000-4-2 (Electrostatic discharge test) EN 61000-4-3 + A1 + A2 / BS EN 61000-4-3 + A1 + A2 (Radiated, radio-frequency, electromagnetic field test) EN 61000-4-4 + A1 / BS EN 61000-4-4 + A1 (Burst Electrical fast transients/burst test) EN 61000-4-5 / BS EN 61000-4-5 (Surge test) EN 61000-4-6 / BS EN 61000-4-6 (to conducted disturbances, induced by radio- frequency fields) EN 61000-4-8 / BS EN 61000-4-8 (power frequency magnetic field test) EN 61000-6-2 + B1 / BS EN 61000-6-2 + B1 (for industrial environments)
Configuration	Configuration Software Master and Slave	SYCON.net
	Configuration Software Slave	netX Configuration Tool

¹⁷ X1, X2 corresponds to the Hilscher convention for „interface“ on the top or the bottom side of the PC Card cifX.

Table 140: Technical Data CIFX 90E-2CO\ET\F, CIFX 90E-2CO\MR\ET\F

9.1.18 CIFX 90E-2CO\ET\F, CIFX 90E-2CO\MR\ET\F

CIFX 90E-2CO\ET\F, CIFX 90E-2CO\MR\ET\F	Parameter	Value	
Part	Name, Part No.	CIFX 90E-2CO\ET\F	1293.504
		CIFX 90E-2CO\MR\ET\F	1293.506
	Description	PC Card cifX Mini PCI Express with 2 channels CANopen Master or Slave (as variants with additional MRAM ,MR' and enlarged temperature range ,ET') composed of: - Basic card CIFX 90E-2FB\ET or CIFX 90E-2FB\MR\ET with cable connector Fieldbus X3 and X4, - CANopen detached network interface (AIFX-CO). Note: The device height and the power input of the PC Card Mini PCI Express CIFX 90E-2CO\ET\F and CIFX 90E-2CO\MR\ET\F do not comply with the standard specifications.	
Function	Communication Interface with Mini PCI Express and 2 x CANopen interface		
Communication Controller	Type	netX 100 processor	
Integrated Memory	RAM	8 MB SDRAM	
	FLASH	4 MB serial Flash EPROM	
	Size of the Dual-Port Memory	64 KByte	
	MRAM (only CIFX 90E-2CO\MR\ET\F)	128Kbyte (= 64K Words); Note: Using the cifX Device Driver (from Version 1.1.1.0) access to this memory is possible and it can be used as a remanent memory.	
System Interface	Bus Type	Mini PCI Express One Lane Port, according to [bus spec 2] and [bus spec 6], refer to section <i>Overview</i> , page 155 and <i>Pin Assignment for Mini PCI Express Bus / SYNC Connector (Bootstart), X1/X2</i> , page 158.	
	Transmission Rate	33 MHz	
	Data Access	DPM or DMA (Direct Memory Access)	
	Width for the data access to the Dual-Port Memory (DPM)	32-Bit	
CANopen Communication	Supported communication standard/ protocol (determined by the loaded firmware)	CANopen Master, CANopen Slave	
CANopen Interface	Transmission rate	10 kBit/s, 20 kBit/s, 50 kBit/s, 100 kBit/s, 125 kBit/s, 250 kBit/s, 500 kBit/s, 800 kBit/s, 1 MBit/s	
	Interface Type	ISO-11898, refer to section <i>CANopen Interface</i> , page 141.	
	CANopen detached Network Interface	AIFX-CO, refer to section <i>AIFX-CO</i> , page 221. Important! Operating the PC card CIFX 90E-2CO\ET\F or CIFX 90E-2CO\MR\ET\F requires proper connection of both CANopen detached network interfaces (AIFX-CO) to the basic card!	
	Connector AIFX-CO	Connector Fieldbus X3 and X4 (JST 10FMN-SMT-A-TF(LF)(SN), Pitch 1,0 mm)	
Display	LED Display	SYS System Status LED	
		For LEDs at AIFX-CO, refer to section <i>AIFX-CO</i> , page 221.	
Power supply	Supply Voltage	+3.3 V dc $\pm 5\%$, refer to section <i>Power Supply and Host Interface</i> on page 67. Important! For all PC cards cifX Mini PCI Express, the increase of the supply voltage from 0V to 3.3V must last longer than 180 μ s.	
	Current consumption at 3.3 V	800 mA (maximum)	
	Connector	Via Mini PCI Express Bus	

CIFX 90E-2CO\ET\F, CIFX 90E-2CO\MR\ET\F	Parameter	Value
Environmental Conditions		CIFX 90E-2CO\ET\F, CIFX 90E-2CO\MR\ET\F
	Operating temperature range*	-20 °C ... +70 °C
	Storage temperature range	-40 °C ... +85 °C
	*Air flow during measurement	0,5 m/s
	Humidity	10 ... 95% relative humidity, no condensation permitted
Device	Dimensions (L x W x H)	CIFX 90E-2CO\ET\F, CIFX 90E-2CO\MR\ET\F 51 x 30,2 +/- 0,1 x 12,5 mm For details on the element heights refer to section <i>Notes on the Card Height - PC Card cifX Mini PCI and Mini PCIe</i> on page 64.
	Mounting/Installation	PCI Express Mini System Connector (3.3 V), X1/X2 ¹⁸ = One Lane, refer to section <i>Slot for the PC Cards cifX Compact PCI, Mini PCI, Mini PCIe, PCI-104</i> , page 63.
	RoHS	Yes
	Compliance with EMC	CE Sign
	UKCA Sign	Yes
	Emission	EN 55011+ A1, CISPR 11, Class A / BS EN 55011+ A1, CISPR 11, Class A (Radio disturbance characteristics - Limits and methods of measurement)
	Immunity	EN 61000-4-2 / BS EN 61000-4-2 (Electrostatic discharge test) EN 61000-4-3 + A1 + A2 / BS EN 61000-4-3 + A1 + A2 (Radiated, radio-frequency, electromagnetic field test) EN 61000-4-4 + A1 / BS EN 61000-4-4 + A1 (Burst Electrical fast transients/burst test) EN 61000-4-5 / BS EN 61000-4-5 (Surge test) EN 61000-4-6 / BS EN 61000-4-6 (to conducted disturbances, induced by radio- frequency fields) EN 61000-4-8 / BS EN 61000-4-8 (power frequency magnetic field test) EN 61000-6-2 + B1 / BS EN 61000-6-2 + B1 (for industrial environments)
Configuration	Configuration Software Master and Slave	SYCON.net
	Configuration Software Slave	netX Configuration Tool

Table 141: Technical Data CIFX 90E-2CO\ET\F, CIFX 90E-2CO\MR\ET\F

9.1.19 CIFX 90E-2CO\DN\ET\F, CIFX 90E-2CO\DN\MR\ET\F

CIFX 90E-2CO\DN\ET\F, CIFX 90E-2CO\DN\MR\ET\F	Parameter	Value
Part	Name, Part No.	CIFX 90E-2CO\DN\ET\F 1293.574
		CIFX 90E-2CO\DN\MR\ET\F 1293.576
	Description	PC Card cifX Mini PCI Express with 2 channels - Channel X1: CANopen Master or Slave, Channel X2: DeviceNet Master or Slave (as variants with additional MRAM ,MR' and enlarged temperature range ,ET') composed of: - Basic card CIFX 90E-2FB\ET or CIFX 90E-2FB\MR\ET with cable connector Fieldbus X3 and X4,

¹⁸ X1, X2 corresponds to the Hilscher convention for „interface“ on the top or the bottom side of the PC Card cifX.

CIFX 90E-2CO\DN\NET\F, CIFX 90E-2CO\DN\MR\ET\F	Parameter	Value
		- CANopen detached network interface (AIFX-DP) and - DeviceNet detached network interface (AIFX-DN). Note: The device height and the power input of the PC Card Mini PCI Express CIFX 90E-2CO\DN\NET\F and CIFX 90E-2CO\DN\MR\ET\F do not comply with the standard specifications.
	Function	Communication Interface with Mini PCI Express, 1 x CANopen interface and 1x DeviceNet interface
Communication Controller	Type	netX 100 processor
Integrated Memory	RAM	8 MB SDRAM
	FLASH	4 MB serial Flash EPROM
	Size of the Dual-Port Memory	64 KByte
	MRAM (only CIFX 90E-2CO\DN\MR\ET\F)	128Kbyte (= 64K Words); Note: Using the cifX Device Driver (from Version 1.1.1.0) access to this memory is possible and it can be used as a remanent memory.
System Interface	Bus Type	Mini PCI Express One Lane Port, according to [bus spec 2] and [bus spec 6], refer to section <i>Overview</i> , page 155 and <i>Pin Assignment for Mini PCI Express Bus / SYNC Connector (Bootstart), X1/X2</i> , page 158.
	Transmission Rate	33 MHz
	Data Access	DPM or DMA (Direct Memory Access)
	Width for the data access to the Dual-Port Memory (DPM)	32-Bit
CANopen Communication	Supported communication standard/ protocol (determined by the loaded firmware)	CANopen Master, CANopen Slave
CANopen Interface	Transmission rate	10 kBit/s, 20 kBit/s, 50 kBit/s, 100 kBit/s, 125 kBit/s, 250 kBit/s, 500 kBit/s, 800 kBit/s, 1 MBit/s
	Interface Type	ISO-11898, refer to section <i>CANopen Interface</i> , page 141.
	CANopen detached Network Interface	AIFX-CO, refer to section <i>AIFX-CO</i> , page 221. Important! Operating the PC card CIFX 90E-2CO\DN\NET\F or CIFX 90E-2CO\DN\MR\ET\F requires proper connection of the CANopen detached network interface (AIFX-CO) and of the DeviceNet detached network interface (AIFX-DN) to the basic card!
	Connector AIFX-CO	Connector Fieldbus X3 (JST 10FMN-SMT-A-TF(LF)(SN), Pitch 1,0 mm)
DeviceNet Communication	Supported communication standard/ protocol (determined by the loaded firmware)	DeviceNet Master, DeviceNet Slave
DeviceNet Interface	Transmission rate	125 kBit/s, 250 kBit/s, 500 kBit/s
	Interface Type	ISO-11898 according to DeviceNet specification, refer to section <i>DeviceNet Interface</i> , page 142
	DeviceNet detached Network Interface	AIFX-DN, refer to section <i>AIFX-DN</i> , page 222. Important! Operating the PC card CIFX 90E-2CO\DN\NET\F or CIFX 90E-2CO\DN\MR\ET\F requires proper connection of the CANopen detached network interface (AIFX-CO) and of the DeviceNet detached network interface (AIFX-DN) to the basic card!
	Connector AIFX-DN	Connector Fieldbus X4 (JST 10FMN-SMT-A-TF(LF)(SN), Pitch 1,0 mm)
Display	LED Display	SYS System Status LED
		For the LEDs at AIFX-Co at channel X1, refer to section <i>AIFX-CO</i> , page 221. For the LEDs at AIFX-DN at channel X2, refer to section <i>AIFX-DN</i> , page 222.

CIFX 90E-2CO\DN\ET\F, CIFX 90E-2CO\DN\MR\ET\F	Parameter	Value
Power supply	Supply Voltage	+3.3 V dc ±5 %, refer to section <i>Power Supply and Host Interface</i> on page 67. <i>Important!</i> For all PC cards cifX Mini PCI Express, the increase of the supply voltage from 0V to 3.3V must last longer than 180 µs.
	Current consumption at 3.3 V	800 mA (maximum)
	Connector	Via Mini PCI Express Bus
Environmental Conditions		CIFX 90E-2CO\DN\ET\F, CIFX 90E-2CO\DN\MR\ET\F
	Operating temperature range*	-20 °C ... +70 °C
	Storage temperature range	-40 °C ... +85 °C
	*Air flow during measurement	0,5 m/s
	Humidity	10 ... 95% relative humidity, no condensation permitted
Device	Dimensions (L x W x H)	CIFX 90E-2CO\DN\ET\F, CIFX 90E-2CO\DN\MR\ET\F 51 x 30,2 +/- 0,1 x 12,5 mm For details on the element heights refer to section <i>Notes on the Card Height - PC Card cifX Mini PCI and Mini PCIe</i> on page 64.
	Mounting/Installation	PCI Express Mini System Connector (3.3 V), X1/X2 ¹⁹ = One Lane, refer to section <i>Slot for the PC Cards cifX Compact PCI, Mini PCI, Mini PCIe, PCI-104</i> , page 63.
	RoHS	Yes
	Compliance with EMC	CE Sign
	UKCA Sign	Yes
	Emission	EN 55011+ A1, CISPR 11, Class A / BS EN 55011+ A1, CISPR 11, Class A (Radio disturbance characteristics - Limits and methods of measurement)
	Immunity	EN 61000-4-2 / BS EN 61000-4-2 (Electrostatic discharge test) EN 61000-4-3 + A1 + A2 / BS EN 61000-4-3 + A1 + A2 (Radiated, radio-frequency, electromagnetic field test) EN 61000-4-4 + A1 / BS EN 61000-4-4 + A1 (Burst Electrical fast transients/burst test) EN 61000-4-5 / BS EN 61000-4-5 (Surge test) EN 61000-4-6 / BS EN 61000-4-6 (to conducted disturbances, induced by radio- frequency fields) EN 61000-4-8 / BS EN 61000-4-8 (power frequency magnetic field test) EN 61000-6-2 + B1 / BS EN 61000-6-2 + B1 (for industrial environments)
Configuration	Configuration Software Master and Slave	SYCON.net
	Configuration Software Slave	netX Configuration Tool

Table 142: Technical Data CIFX 90E-2CO\DN\ET\F, CIFX 90E-2CO\DN\MR\ET\F

9.1.20 CIFX 90E-2DN\ET\F, CIFX 90E-2DN\MR\ET\F

CIFX 90E-2DN\ET\F, CIFX 90E-2DN\MR\ET\F	Parameter	Value
Part	Name, Part No.	CIFX 90E-2DN\ET\F 1293.514

¹⁹ X1, X2 corresponds to the Hilscher convention for „interface“ on the top or the bottom side of the PC Card cifX.

CIFX 90E-2DN\ET\F, CIFX 90E-2DN\MR\ET\F	Parameter	Value
		CIFX 90E-2DN\MR\ET\F 1293.516
	Description	PC Card cifX Mini PCI Express with 2 channels DeviceNet Master or Slave (as variants with additional MRAM ,MR' and enlarged temperature range ,ET') composed of: - Basic card CIFX 90E-2FB\ET or CIFX 90E-2FB\MR\ET with cable connector Fieldbus X3 and X4, - DeviceNet detached network interface (AIFX-DN). Note: The device height and the power input of the PC Card Mini PCI Express CIFX 90E-2DN\ET\F and CIFX 90E-2DN\MR\ET\F do not comply with the standard specifications.
	Function	Communication Interface with Mini PCI Express and 2 x DeviceNet interface
Communication Controller	Type	netX 100 processor
Integrated Memory	RAM	8 MB SDRAM
	FLASH	4 MB serial Flash EPROM
	Size of the Dual-Port Memory	64 KByte
	MRAM (only CIFX 90E-2DN\MR\ET\F)	128Kbyte (= 64K Words); Note: Using the cifX Device Driver (from Version 1.1.1.0) access to this memory is possible and it can be used as a remanent memory.
System Interface	Bus Type	Mini PCI Express One Lane Port, according to [bus spec 2] and [bus spec 6], refer to section <i>Overview</i> , page 155 and <i>Pin Assignment for Mini PCI Express Bus / SYNC Connector (Bootstart)</i> , X1/X2, page 158.
	Transmission Rate	33 MHz
	Data Access	DPM or DMA (Direct Memory Access)
	Width for the data access to the Dual-Port Memory (DPM)	32-Bit
DeviceNet Communication	Supported communication standard/ protocol (determined by the loaded firmware)	DeviceNet Master, DeviceNet Slave
DeviceNet Interface	Transmission rate	125 kBit/s, 250 kBit/s, 500 kBit/s
	Interface Type	ISO-11898 according to DeviceNet specification, refer to section <i>DeviceNet Interface</i> , page 142
	DeviceNet detached Network Interface	AIFX-DN, refer to section <i>AIFX-DN</i> , page 222. Important! Operating the PC card CIFX 90E-2DN\ET\F or CIFX 90E-2DN\MR\ET\F requires proper connection of both DeviceNet detached network interfaces (AIFX-DN) to the basic card!
	Connector AIFX-DN	Connector Fieldbus X3 and X4 (JST 10FMN-SMT-A-TF(LF)(SN), Pitch 1,0 mm)
Display	LED Display	SYS System Status LED For LED at AIFX-DN, refer to section <i>AIFX-DN</i> , p. 222.
Power supply	Supply Voltage	+3.3 V dc $\pm 5\%$, refer to section <i>Power Supply and Host Interface</i> on page 67. Important! For all PC cards cifX Mini PCI Express, the increase of the supply voltage from 0V to 3.3V must last longer than 180 μ s.
	Current consumption at 3.3 V	800 mA (maximum)
	Connector	Via Mini PCI Express Bus
Environmental Conditions		CIFX 90E-2DN\ET\F, CIFX 90E-2DN\MR\ET\F
	Operating temperature range*	-20 °C ... +70 °C
	Storage temperature range	-40 °C ... +85 °C
	*Air flow during measurment	0,5 m/s
	Humidity	10 ... 95% relative humidity, no condensation permitted

CIFX 90E-2DN\ET\F, CIFX 90E-2DN\MR\ET\F	Parameter	Value
Device	Dimensions (L x W x H)	CIFX 90E-2DN\ET\F, CIFX 90E-2DN\MR\ET\F
		51 x 30,2 +/- 0,1 x 12,5 mm
		For details on the element heights refer to section <i>Notes on the Card Height - PC Card cifX Mini PCI and Mini PCIe</i> on page 64.
	Mounting/Installation	PCI Express Mini System Connector (3.3 V), X1/X2 ²⁰ = One Lane, refer to section <i>Slot for the PC Cards cifX Compact PCI, Mini PCI, Mini PCIe, PCI-104</i> , page 63.
	RoHS	Yes
Compliance with EMC	CE Sign	Yes
	UKCA Sign	Yes
	Emission	EN 55011+ A1, CISPR 11, Class A / BS EN 55011+ A1, CISPR 11, Class A (Radio disturbance characteristics - Limits and methods of measurement)
	Immunity	EN 61000-4-2 / BS EN 61000-4-2 (Electrostatic discharge test) EN 61000-4-3 + A1 + A2 / BS EN 61000-4-3 + A1 + A2 (Radiated, radio-frequency, electromagnetic field test) EN 61000-4-4 + A1 / BS EN 61000-4-4 + A1 (Burst Electrical fast transients/burst test) EN 61000-4-5 / BS EN 61000-4-5 (Surge test) EN 61000-4-6 / BS EN 61000-4-6 (to conducted disturbances, induced by radio- frequency fields) EN 61000-4-8 / BS EN 61000-4-8 (power frequency magnetic field test) EN 61000-6-2 + B1 / BS EN 61000-6-2 + B1 (for industrial environments)
Configuration	Configuration Software Master and Slave	SYCON.net
	Configuration Software Slave	netX Configuration Tool

Table 143: Technical Data CIFX 90E-2DN\ET\F, CIFX 90E-2DN\MR\ET\F

²⁰ X1, X2 corresponds to the Hilscher convention for „interface“ on the top or the bottom side of the PC Card cifX.

9.1.21 CIFX 104C-RE, CIFX 104C-RE-R

CIFX 104C-RE, CIFX 104C-RE-R	Parameter	Value	
Part	Name, Part No.	CIFX 104C-RE	1270.100
		CIFX 104C-RE-R	1271.100
	Description	PC Card cifX PCI-104 for Real-Time Ethernet Master or Slave; (for CIFX 104C-RE-R connectors at the left side)	
	Function	Communication Interface with PCI-104 and Ethernet interface	
Communication Controller	Type	netX 500 processor	
Integrated Memory	RAM	8 MB SDRAM	
	FLASH	4 MB serial Flash EPROM	
	Size of the Dual-Port Memory	64 KByte	
System Interface	Bus Type	PCI-104, according to [bus spec 7], refer to section <i>Overview</i> , page 155.	
	Transmission Rate	33 MHz	
	Data Access	DPM or DMA (Direct Memory Access)	
	Width for the data access to the Dual-Port Memory (DPM)	32-Bit	
Ethernet Communication	Supported Real-Time Ethernet communication systems (determined by the loaded firmware)	CC-Link IE Field Basic Slave	
		EtherCAT Master, EtherCAT Slave	
		EtherNet/IP Scanner (Master), EtherNet/IP Adapter (Slave),	
		Open Modbus/TCP	
		POWERLINK Controlled Node/Slave	
		PROFINET IO-Controller (Master), PROFINET IO-Device (Slave)	
		Sercos Master, Sercos Slave	
	VARAN Client (Slave)		
Ethernet Frame Types	Ethernet II		
Ethernet interface	Transmission Rate	100 MBit/s, 10 MBit/s (depending on loaded firmware)	
	Interface Type	100 BASE-TX, 10 BASE-T (depending on loaded firmware), refer to section <i>Ethernet Interface</i> , page 138.	
	Galvanic Isolation	isolated	
	Isolation Voltage	1000 VDC (tested for 1 minute)	
	Half duplex/Full duplex	depending on loaded firmware, supported (at 100 MBit/s)	
	Auto-Negotiation	depending on loaded firmware	
	Auto-Crossover	depending on loaded firmware	
Connector	2* RJ45 Socket		
Diagnosis Interface	USB Interface	Mini B USB Plug (5 pin), refer to section <i>Mini-B USB Connector (5 Pin)</i> , page 143.	

CIFX 104C-RE, CIFX 104C-RE-R	Parameter	Value
Display	LED Display	<p>SYS System Status LED</p> <p>The meaning of the following LEDs depends on the loaded firmware:</p> <p>COM 0 LED Communication Status 0 (duo LED)</p> <p>COM 1 LED Communication Status 1 (duo LED)</p> <p>LED yellow at RJ45Ch0 and RJ45Ch1, for Ethernet Link status, Ethernet Activity status and additional status</p> <p>LED green</p> <p>Refer to chapter <i>Diagnosis with LEDs</i>, page 104.</p>
Power supply	Supply Voltage	+5 V dc $\pm 5\%$ or +3.3 V dc $\pm 5\%$, refer to section <i>Power Supply and Host Interface</i> on page 67.
	Current consumption at 5 V or at 3.3 V.....	500 mA (maximum) 730 mA (maximum)
	Connector	Via PCI-104 Bus
Operation	Rotary Switch PCI-104 Slot Number	To set the PCI-104 Slot Number, refer to section <i>Rotary Switch for PCI-104 Slot Number</i> , page 143.
	Rotary Switch Device Address	Is currently unassigned. Refer to section <i>Rotary Switch Device Address</i> on page 144.
Environmental Conditions	Operating temperature range*	0 °C ... +70 °C
	*Air flow during measurement	0,5 m/s
	Storage temperature range	-40 °C ... +85 °C
	Humidity	10 ... 95% relative humidity, no condensation permitted
	Environment	For UL compliant usage: The device must be used in a pollution degree 2 environment.
Device	Dimensions (L x W x H)	97 x 91 x 24 mm
	Mounting/Installation	PCI-104 Slot (Supply Voltage 5 V or 3.3 V, Signaling Voltage 5 V or 3.3 V), refer to section <i>Slot for the PC Cards cifX Compact PCI, Mini PCI, Mini PCIe, PCI-104</i> , page 63.
	RoHS	Yes
Compliance with EMC	CE Sign	Yes
	UKCA Sign	Yes
	Emission	EN 55011+ A1, CISPR 11, Class A / BS EN 55011+ A1, CISPR 11, Class A (Radio disturbance characteristics - Limits and methods of measurement)
	Immunity	EN 61000-4-2 / BS EN 61000-4-2 (Electrostatic discharge test) EN 61000-4-3 + A1 + A2 / BS EN 61000-4-3 + A1 + A2 (Radiated, radio-frequency, electromagnetic field test) EN 61000-4-4 + A1 / BS EN 61000-4-4 + A1 (Burst Electrical fast transients/burst test) EN 61000-4-5 / BS EN 61000-4-5 (Surge test) EN 61000-4-6 / BS EN 61000-4-6 (to conducted disturbances, induced by radio- frequency fields) EN 61000-4-8 / BS EN 61000-4-8 (power frequency magnetic field test) EN 61000-6-2 + B1 / BS EN 61000-6-2 + B1 (for industrial environments)
UL Certification	The devices CIFX 104C-RE and CIFX 104C-RE-R are certified	UL-File-Nr. E221530

CIFX 104C-RE, CIFX 104C-RE-R	Parameter	Value
	according to UL 508	
Configuration	Configuration Software Master and Slave	SYCON.net
	Configuration Software Slave	netX Configuration Tool

Table 144: Technical Data CIFX 104C-RE, CIFX 104C-RE-R

9.1.22 CIFX 104C-RE\F, CIFX 104C-RE-R\F and Variants

CIFX 104C-RE\F, CIFX 104C-RE-R\F and Variants	Parameter	Value	
Part	Name, Part No.	CIFX 104C-RE\F	1270.101
		CIFX 104C-RE-R\F	1271.101
		CIFX 104C-RE\FM12	1270.121
		CIFX 104C-RE-R\FM12	1271.121
	Description	PC Card cifX PCI-104 for Real-Time Ethernet Master or Slave composed of: - Basic card CIFX 104C-RE\F or CIFX 104C-RE-R\F* with cable connector Ethernet X304 (X4) and cable connector DIAG X303 (X3) (*connectors at the left side) - Ethernet detached network interface (AIFX-RE) or - Ethernet M12 detached network interface (AIFX-RE\M12) and - diagnostic detached network interface (AIFX-DIAG).	
Function	Communication Interface with PCI-104 and Ethernet interface		
Communication Controller	Type	netX 500 processor	
Integrated Memory	RAM	8 MB SDRAM	
	FLASH	4 MB serial Flash EPROM	
	Size of the Dual-Port Memory	64 KByte	
System Interface	Bus Type	PCI-104, according to [bus spec 7], refer to section <i>Overview</i> , page 155.	
	Transmission Rate	33 MHz	
	Data Access	DPM or DMA (Direct Memory Access)	
	Width for the data access to the Dual-Port Memory (DPM)	32-Bit	
Ethernet Communication	Supported Real-Time Ethernet communication systems (determined by the loaded firmware)	CC-Link IE Field Basic Slave	
		EtherCAT Master, EtherCAT Slave	
		EtherNet/IP Scanner (Master), EtherNet/IP Adapter (Slave),	
		Open Modbus/TCP	
		POWERLINK Controlled Node/Slave	
		PROFINET IO-Controller (Master), PROFINET IO-Device (Slave)	
		Sercos Master, Sercos Slave	
	VARAN Client (Slave)		
Ethernet Frame Types	Ethernet II		
Ethernet interface	Transmission Rate	100 MBit/s, 10 MBit/s (depending on loaded firmware)	
	Interface Type	100 BASE-TX, 10 BASE-T (depending on loaded firmware),	

CIFX 104C-RE\F, CIFX 104C-RE-R\F and Variants	Parameter	Value
		refer to section <i>Ethernet Interface</i> , page 138.
	Half duplex/Full duplex	depending on loaded firmware, supported (at 100 MBit/s)
	Auto-Negotiation	depending on loaded firmware
	Auto-Crossover	depending on loaded firmware
	Detached network interface Ethernet, detached network interface Ethernet M12	AIFX-RE, refer to section <i>AIFX-RE</i> , page 218 or AIFX-RE\M12, refer to section <i>AIFX-RE\M12</i> , page 219. Important! Operating the PC card CIFX 104C-RE\F or CIFX 104C-RE-R\F requires proper connection of the Ethernet detached network interface (AIFX-RE) or the Ethernet M12 detached network interface (AIFX-RE\M12) to the basic card!
	Connector AIFX-RE or AIFX-RE\M12	Cable Connector Ethernet X304 (X4) (JST SM20B-SRSS-TB(LF)(SN), Pitch 1,0 mm)
Diagnosis Interface	Diagnostic detached Network Interface	AIFX-DIAG, refer to section <i>AIFX-DIAG</i> , Page 224. Note: If the diagnostic AIFX-DIAG detached network interface is connected to the PC card CIFX 104C-RE\F, CIFX 104C-RE-R\F, CIFX 104C-RE\F\M12 or CIFX 104C-RE-R\F\M12, the Mini-B USB connector on the AIFX-DIAG can be used beginning with the hardware revision 5 of the PC card cifX.
	Connector AIFX-DIAG	Cable Connector DIAG X303 (X3) (JST 12FMN-SMT-A-TF(LF)(SN), Pitch 1,0 mm)
Display	LED Display	SYS System Status LED For LEDs at AIFX-RE, refer to section <i>AIFX-RE</i> , page 218 or at AIFX-RE\M12, to section <i>AIFX-RE\M12</i> , page 219.
Power supply	Supply Voltage	+5 V dc ±5 % or +3.3 V dc ±5 %, refer to section <i>Power Supply and Host Interface</i> on page 67.
	Current consumption at 5 V or at 3.3 V.....	500 mA (maximum) 730 mA (maximum)
	Connector	Via PCI-104 Bus
Operation	Rotary Switch PCI-104 Slot Number	To set the PCI-104 Slot Number, refer to section <i>Rotary Switch for PCI-104 Slot Number</i> , page 143.
Environmental Conditions	Operating temperature range*	0 °C ... +70 °C
	*Air flow during measurment	0,5 m/s
	Storage temperature range	-40 °C ... +85 °C
	Humidity	10 ... 95% relative humidity, no condensation permitted
	Environment	For UL compliant usage: The device must be used in a pollution degree 2 environment.
Device	Dimensions (L x W x H)	97 x 91 x 24 mm
	Mounting/Installation	PCI-104 Slot (Supply Voltage 5 V or 3.3 V, Signaling Voltage 5 V or 3.3 V), refer to section <i>Slot for the PC Cards cifX Compact PCI, Mini PCI, Mini PCIe, PCI-104</i> , page 63.
	RoHS	Yes
Compliance with EMC	CE Sign	Yes
	UKCA Sign	Yes
	Emission	EN 55011+ A1, CISPR 11, Class A / BS EN 55011+ A1, CISPR 11, Class A (Radio disturbance characteristics - Limits and methods of measurement)
	Immunity	EN 61000-4-2 / BS EN 61000-4-2 (Electrostatic discharge test) EN 61000-4-3 + A1 + A2 / BS EN 61000-4-3 + A1 + A2

CIFX 104C-RE\F, CIFX 104C-RE-R\F and Variants	Parameter	Value
		(Radiated, radio-frequency, electromagnetic field test) EN 61000-4-4 + A1 / BS EN 61000-4-4 + A1 (Burst Electrical fast transients/burst test) EN 61000-4-5 / BS EN 61000-4-5 (Surge test) EN 61000-4-6 / BS EN 61000-4-6 (to conducted disturbances, induced by radio- frequency fields) EN 61000-4-8 / BS EN 61000-4-8 (power frequency magnetic field test) EN 61000-6-2 + B1 / BS EN 61000-6-2 + B1 (for industrial environments)
UL Certification	The devices CIFX 104C-RE\F and CIFX 104C-RE-R\F are certified according to UL 508	UL-File-Nr. E221530
Configuration	Configuration Software Master and Slave	SYCON.net
	Configuration Software Slave	netX Configuration Tool

Table 145: Technical Data CIFX 104C-RE\F, CIFX 104C-RE-R\F, CIFX 104C-RE\FM12 or CIFX 104C-RE-R\FM12

9.1.23 CIFX 104C-DP, CIFX 104C-DP-R

CIFX 104C-DP, CIFX 104C-DP-R	Parameter	Value
Part	Name, Part No.	CIFX 104C-DP 1270.410
		CIFX 104C-DP-R 1271.410
	Description	PC Card cifX PCI-104 PROFIBUS DP Master or Slave and PROFIBUS MPI Device; (for CIFX 104C-DP-R connectors at the left side)
	Function	Communication Interface with PCI-104 and fieldbus interface PROFIBUS
Communication Controller	Type	netX 100 processor
Integrated Memory	RAM	8 MB SDRAM
	FLASH	4 MB serial Flash EPROM
	Size of the Dual-Port Memory	64 KByte
System Interface	Bus Type	PCI-104, according to [bus spec 7], refer to section <i>Overview</i> , page 155.
	Transmission Rate	33 MHz
	Data Access	DPM or DMA (Direct Memory Access)
	Width for the data access to the Dual-Port Memory (DPM)	32-Bit
PROFIBUS Communication	Supported communication standard/ protocol (determined by the loaded firmware)	PROFIBUS DP Master, PROFIBUS DP Slave, PROFIBUS MPI Device
PROFIBUS Interface	Transmission Rate	9,6 kBit/s, 19,2 kBit/s, 31,25 kBit/s, 45,45 kBit/s, 93,75 kBit/s, 187,5 kBit/s, 500 kBit/s, 1,5 MBit/s, 3 MBit/s, 6 MBit/s, 12 MBit/s
	Interface Type	RS 485, refer to section <i>PROFIBUS Interface</i> , page 141.
	Galvanic Isolation	isolated
	Isolation Voltage	1000 VDC (tested for 1 minute)
	Connector	DSub female Connector, 9 pin

CIFX 104C-DP, CIFX 104C-DP-R	Parameter	Value
Diagnosis Interface	USB Interface	Mini B USB Plug (5 pin), refer to section <i>Mini-B USB Connector (5 Pin)</i> , page 143.
Display	LED Display	SYS System Status LED COM 0 LED Communication Status 0 (duo LED) The meaning of the COM LED depends on the loaded firmware. Refer to chapter <i>Diagnosis with LEDs</i> , page 104.
Power supply	Supply Voltage	+5 V dc $\pm 5\%$ or +3.3 V dc $\pm 5\%$, refer to section <i>Power Supply and Host Interface</i> on page 67.
	Current consumption at 5 V or at 3.3 V.....	500 mA (maximum) 650 mA (maximum)
	Connector	Via PCI-104 Bus
Operation	Rotary Switch PCI-104 Slot Number	To set the PCI-104 Slot Number, refer to section <i>Rotary Switch for PCI-104 Slot Number</i> , page 143.
	Rotary Switch Device Address	Is currently unassigned. Refer to section <i>Rotary Switch Device Address</i> on page 144.
Environmental Conditions	Operating temperature range*	-20 °C ... +70 °C (<i>acc. to UL: 0 °C ... +55 °C</i>)
	*Air flow during measurement	0,5 m/s
	Storage temperature range	-40 °C ... +85 °C
	Humidity	10 ... 95% relative humidity, no condensation permitted
	Environment	For UL compliant usage: The device must be used in a pollution degree 2 environment.
Device	Dimensions (L x W x H)	97 x 91 x 24 mm
	Mounting/Installation	PCI-104 Slot (Supply Voltage 5 V or 3.3 V, Signaling Voltage 5 V or 3.3 V), refer to section <i>Slot for the PC Cards cifX Compact PCI, Mini PCI, Mini PCIe, PCI-104</i> , page 63
	RoHS	Yes
Compliance with EMC	CE Sign	Yes
	UKCA Sign	Yes
	Emission	EN 55011+ A1, CISPR 11, Class A / BS EN 55011+ A1, CISPR 11, Class A (Radio disturbance characteristics - Limits and methods of measurement)
	Immunity	EN 61000-4-2 / BS EN 61000-4-2 (Electrostatic discharge test) EN 61000-4-3 + A1 + A2 / BS EN 61000-4-3 + A1 + A2 (Radiated, radio-frequency, electromagnetic field test) EN 61000-4-4 + A1 / BS EN 61000-4-4 + A1 (Burst Electrical fast transients/burst test) EN 61000-4-5 / BS EN 61000-4-5 (Surge test) EN 61000-4-6 / BS EN 61000-4-6 (to conducted disturbances, induced by radio- frequency fields) EN 61000-4-8 / BS EN 61000-4-8 (power frequency magnetic field test) EN 61000-6-2 + B1 / BS EN 61000-6-2 + B1 (for industrial environments)
UL Certification	The devices CIFX 104C-DP and CIFX 104C-DP-R are certified according to UL 508	UL-File-Nr. E221530
Configuration	Configuration Software Master and Slave	SYCON.net
	Configuration Software Slave	netX Configuration Tool

Table 146: Technical Data CIFS 104C-DP, CIFS 104C-DP-R

9.1.24 CIFS 104C-DP, CIFS 104C-DP-R

CIFS 104C-DP, CIFS 104C-DP-R	Parameter	Wert	
Part	Name, Part No.	CIFS 104C-DP	1270.411
		CIFS 104C-DP-R	1271.411
	Description	PC Card cifX PCI-104 PROFIBUS DP Master or Slave and PROFIBUS MPI Device composed of: - Basic card CIFS 104C-FB or CIFS 104C-FB-R* with cable connector Fieldbus X304 (X4) and cable connector DIAG X303 (X3) (*connectors at the left side) - PROFIBUS detached network interface (AIFX-DP) and - diagnostic detached network interface (AIFX-DIAG).	
	Function	Communication Interface with PCI-104 and fieldbus interface PROFIBUS	
Communication Controller	Type	netX 100 processor	
Integrated Memory	RAM	8 MB SDRAM	
	FLASH	4 MB serial Flash EPROM	
	Size of the Dual-Port Memory	64 KByte	
System Interface	Bus Type	PCI-104, according to [bus spec 7], refer to section <i>Overview</i> , page 155.	
	Transmission Rate	33 MHz	
	Data Access	DPM or DMA (Direct Memory Access)	
	Width for the data access to the Dual-Port Memory (DPM)	32-Bit	
PROFIBUS Communication	Supported communication standard/ protocol (determined by the loaded firmware)	PROFIBUS DP Master, PROFIBUS DP Slave, PROFIBUS MPI Device	
PROFIBUS Interface	Transmission Rate	9,6 kBit/s, 19,2 kBit/s, 31,25 kBit/s, 45,45 kBit/s, 93,75 kBit/s, 187,5 kBit/s, 500 kBit/s, 1,5 MBit/s, 3 MBit/s, 6 MBit/s, 12 MBit/s	
	Interface Type	RS 485, refer to section <i>PROFIBUS Interface</i> page 141.	
	PROFIBUS detached Network Interface	AIFX-DP, refer to section <i>AIFX-DP</i> page 220. Important! Operating the PC card CIFS 104C-DP or CIFS 104C-DP-R requires proper connection of the PROFIBUS detached network interface (AIFX-DP) to the basic card!	
	Connector AIFX-DP	Cable Connector Fieldbus X304 (X4) (JST 10FMN-SMT-A-TF(LF)(SN), Pitch 1,0 mm)	
Diagnosis Interface	Diagnostic detached Network Interface	AIFX-DIAG, refer to section <i>AIFX-DIAG</i> , Page 224.	
	Connector AIFX-DIAG	Cable Connector DIAG X303 (X3) (JST 12FMN-SMT-A-TF(LF)(SN), Pitch 1,0 mm)	
Display	LED Display	SYS System Status LED	
		For LEDs at AIFX-DP, refer to section <i>AIFX-DP</i> page 220.	
Power supply	Supply Voltage	+5 V dc $\pm 5\%$ or +3.3 V dc $\pm 5\%$, refer to section <i>Power Supply and Host Interface</i> on page 67.	
	Current consumption at 5 V or at 3.3 V.....	500 mA (maximum) 650 mA (maximum)	
	Connector	Via PCI-104 Bus	
Operation	Rotary Switch PCI-104 Slot Number	To set the PCI-104 Slot Number, refer to section <i>Rotary Switch for PCI-104 Slot Number</i> , page 143.	

CIFX 104C-DP\F, CIFX 104C-DP-R\F	Parameter	Wert
Environmental Conditions	Operating temperature range*	-20 °C ... +70 °C (acc. to UL: 0 °C ... +55 °C)
	*Air flow during measurement	0,5 m/s
	Storage temperature range	-40 °C ... +85 °C
	Humidity	10 ... 95% relative humidity, no condensation permitted
	Environment	For UL compliant usage: The device must be used in a pollution degree 2 environment.
Device	Dimensions (L x W x H)	97 x 91 x 24 mm
	Mounting/Installation	PCI-104 Slot (Supply Voltage 5 V or 3.3 V, Signaling Voltage 5 V or 3.3 V), refer to section <i>Slot for the PC Cards cifX Compact PCI, Mini PCI, Mini PCIe, PCI-104</i> , page 63.
	RoHS	Yes
Compliance with EMC	CE Sign	Yes
	UKCA Sign	Yes
	Emission	EN 55011+ A1, CISPR 11, Class A / BS EN 55011+ A1, CISPR 11, Class A (Radio disturbance characteristics - Limits and methods of measurement)
	Immunity	EN 61000-4-2 / BS EN 61000-4-2 (Electrostatic discharge test) EN 61000-4-3 + A1 + A2 / BS EN 61000-4-3 + A1 + A2 (Radiated, radio-frequency, electromagnetic field test) EN 61000-4-4 + A1 / BS EN 61000-4-4 + A1 (Burst Electrical fast transients/burst test) EN 61000-4-5 / BS EN 61000-4-5 (Surge test) EN 61000-4-6 / BS EN 61000-4-6 (to conducted disturbances, induced by radio- frequency fields) EN 61000-4-8 / BS EN 61000-4-8 (power frequency magnetic field test) EN 61000-6-2 + B1 / BS EN 61000-6-2 + B1 (for industrial environments)
UL Certification	The device CIFX 104C-DP\F and CIFX 104C-DP-R\F are certified according to UL 508	UL-File-Nr. E221530
Configuration	Configuration Software Master and Slave	SYCON.net
	Configuration Software Slave	netX Configuration Tool

Table 147: Technical Data CIFX 104C-DP\F, CIFX 104C-DP-R\F

9.1.25 CIFX 104C-CO, CIFX 104C-CO-R

CIFX 104C-CO, CIFX 104C-CO-R	Parameter	Value	
Part	Name, Part No.	CIFX 104C-CO	1270.500
		CIFX 104C-CO-R	1271.500
	Description	PC Card cifX PCI-104 CANopen Master or Slave; (for CIFX 104C-CO-R connectors at the left side)	
	Function	Communication Interface with PCI-104 and fieldbus interface CANopen	
Communication Controller	Type	netX 100 processor	
Integrated Memory	RAM	8 MB SDRAM	
	FLASH	4 MB serial Flash EPROM	
	Size of the Dual-Port Memory	64 KByte	

CIFX 104C-CO, CIFX 104C-CO-R	Parameter	Value
System Interface	Bus Type	PCI-104, according to [bus spec 7], refer to section <i>Overview</i> , page 155.
	Transmission Rate	33 MHz
	Data Access	DPM or DMA (Direct Memory Access)
	Width for the data access to the Dual-Port Memory (DPM)	32-Bit
CANopen Communication	Supported communication standard/ protocol (determined by the loaded firmware)	CANopen Master, CANopen Slave
CANopen Interface	Transmission Rate	10 kBit/s, 20 kBit/s, 50 kBit/s, 100 kBit/s, 125 kBit/s, 250 kBit/s, 500 kBit/s, 800 kBit/s, 1 MBit/s
	Interface Type	ISO-11898, refer to section <i>CANopen Interface</i> , page 141.
	Galvanic Isolation	isolated (optically isolated)
	Isolation Voltage	1000 VDC (tested for 1 minute)
	Connector	DSub male Connector, 9 pin
Diagnosis Interface	USB Interface	Mini B USB Plug (5 pin), refer to section <i>Mini-B USB Connector (5 Pin)</i> , page 143.
Display	LED Display	<p>SYS System Status LED</p> <p>CAN CANopen Status (duo LED)</p> <p>The meaning of the CAN LED is depending on loaded firmware. Refer to chapter <i>Diagnosis with LEDs</i>, page 104.</p>
Power supply	Supply Voltage	+5 V dc $\pm 5\%$ or +3.3 V dc $\pm 5\%$, refer to section <i>Power Supply and Host Interface</i> on page 67.
	Current consumption at 5 V or at 3.3 V.....	500 mA (maximum) 650 mA (maximum)
	Connector	Via PCI-104 Bus
	Operation	
Environmental Conditions	Rotary Switch PCI-104 Slot Number	To set the PCI-104 Slot Number, refer to section <i>Rotary Switch for PCI-104 Slot Number</i> , page 143.
	Rotary Switch Device Address	Is currently unassigned. Refer to section <i>Rotary Switch Device Address</i> on page 144.
	Operating temperature range*	-20 °C ... +70 °C (acc. to UL: 0 °C ... +55 °C)
	*Air flow during measurement	0,5 m/s
	Storage temperature range	-40 °C ... +85 °C
Device	Humidity	10 ... 95% relative humidity, no condensation permitted
	Environment	For UL compliant usage: The device must be used in a pollution degree 2 environment.
	Dimensions (L x W x H)	97 x 91 x 24 mm
	Mounting/Installation	PCI-104 Slot (Supply Voltage 5 V or 3.3 V, Signaling Voltage 5 V or 3.3 V), refer to section <i>Slot for the PC Cards cifX Compact PCI, Mini PCI, Mini PCIe, PCI-104</i> , page 63.
Compliance with EMC	RoHS	Yes
	CE Sign	Yes
	UKCA Sign	Yes
	Emission	EN 55011+ A1, CISPR 11, Class A / BS EN 55011+ A1, CISPR 11, Class A (Radio disturbance characteristics - Limits and methods of measurement)
Immunity	EN 61000-4-2 / BS EN 61000-4-2 (Electrostatic discharge test)	

CIFX 104C-CO, CIFX 104C-CO-R	Parameter	Value
		EN 61000-4-3 + A1 + A2 / BS EN 61000-4-3 + A1 + A2 (Radiated, radio-frequency, electromagnetic field test) EN 61000-4-4 + A1 / BS EN 61000-4-4 + A1 (Burst Electrical fast transients/burst test) EN 61000-4-5 / BS EN 61000-4-5 (Surge test) EN 61000-4-6 / BS EN 61000-4-6 (to conducted disturbances, induced by radio- frequency fields) EN 61000-4-8 / BS EN 61000-4-8 (power frequency magnetic field test) EN 61000-6-2 + B1 / BS EN 61000-6-2 + B1 (for industrial environments)
UL Certification	The device CIFX 104C-CO and CIFX 104C-CO-R are certified according to UL 508	UL-File-Nr. E221530
Configuration	Configuration Software Master and Slave	SYCON.net
	Configuration Software Slave	netX Configuration Tool

Table 148: Technical Data CIFX 104C-CO, CIFX 104C-CO-R

9.1.26 CIFX 104C-CO\F, CIFX 104C-CO-R\F

CIFX 104C-CO\F, CIFX 104C-CO-R\F	Parameter	Value	
Part	Name, Part No.	CIFX 104C-CO\F	1270.501
		CIFX 104C-CO-R\F	1271.501
	Description	PC Card cifX PCI-104 CANopen Master or Slave composed of: - Basic card CIFX 104C-FB\F or CIFX 104C-FB-R\F* with cable connector Fieldbus X304 (X4) and cable connector DIAG X303 (X3) (*connectors at the left side) - CANopen detached network interface (AIFX-CO) and - diagnostic detached network interface (AIFX-DIAG).	
	Function	Communication Interface with PCI-104 and fieldbus interface CANopen	
Communication Controller	Type	netX 100 processor	
Integrated Memory	RAM	8 MB SDRAM	
	FLASH	4 MB serial Flash EPROM	
	Size of the Dual-Port Memory	64 KByte	
System Interface	Bus Type	PCI-104, according to [bus spec 7], refer to section <i>Overview</i> , page 155.	
	Transmission Rate	33 MHz	
	Data Access	DPM or DMA (Direct Memory Access)	
	Width for the data access to the Dual-Port Memory (DPM)	32-Bit	
CANopen Communication	Supported communication standard/ protocol (determined by the loaded firmware)	CANopen Master, CANopen Slave	
CANopen Interface	Transmission Rate	10 kBit/s, 20 kBit/s, 50 kBit/s, 100 kBit/s, 125 kBit/s, 250 kBit/s, 500 kBit/s, 800 kBit/s, 1 MBit/s	
	Interface Type	ISO-11898, refer to section <i>CANopen Interface</i> , page 141.	
	CANopen detached Network Interface	AIFX-CO, refer to section <i>AIFX-CO</i> , page 221. Important! Operating the PC card CIFX 104C-CO\F or CIFX 104C-CO-R\F requires proper connection of the CANopen detached network interface (AIFX-CO) to the basic card!	
	Connector AIFX-CO	Cable Connector Fieldbus X304 (X4) (JST 10FMN-SMT-A-TF(LF)(SN), Pitch 1,0 mm)	
Diagnosis Interface	Diagnostic detached Network Interface	AIFX-DIAG, refer to section <i>AIFX-DIAG</i> , Page 224.	
	Connector AIFX-DIAG	Cable Connector DIAG X303 (X3) (JST 12FMN-SMT-A-TF(LF)(SN), Pitch 1,0 mm)	
Display	LED Display	SYS System Status LED	
		For LEDs at AIFX-CO, refer to section <i>AIFX-CO</i> , p. 221.	
Power supply	Supply Voltage	+5 V dc $\pm 5\%$ or +3.3 V dc $\pm 5\%$, refer to section <i>Power Supply and Host Interface</i> on page 67.	
	Current consumption at 5 V or at 3.3 V.....	500 mA (maximum) 650 mA (maximum)	
	Connector	Via PCI-104 Bus	
Operation	Rotary Switch PCI-104 Slot Number	To set the PCI-104 Slot Number, refer to section <i>Rotary Switch for PCI-104 Slot Number</i> , page 143.	
Environmental Conditions	Operating temperature range*	-20 °C ... +70 °C (acc. to UL: 0 °C ... +55 °C)	
	*Air flow during measurement	0,5 m/s	

CIFX 104C-CO\F, CIFX 104C-CO-R\F	Parameter	Value
	Storage temperature range	-40 °C ... +85 °C
	Humidity	10 ... 95% relative humidity, no condensation permitted
	Environment	For UL compliant usage: The device must be used in a pollution degree 2 environment.
Device	Dimensions (L x W x H)	97 x 91 x 24 mm
	Mounting/Installation	PCI-104 Slot (Supply Voltage 5 V or 3.3 V, Signaling Voltage 5 V or 3.3 V), refer to section <i>Slot for the PC Cards cifX Compact PCI, Mini PCI, Mini PCIe, PCI-104</i> , page 63.
	RoHS	Yes
Compliance with EMC	CE Sign	Yes
	UKCA Sign	Yes
	Emission	EN 55011+ A1, CISPR 11, Class A / BS EN 55011+ A1, CISPR 11, Class A (Radio disturbance characteristics - Limits and methods of measurement)
	Immunity	EN 61000-4-2 / BS EN 61000-4-2 (Electrostatic discharge test) EN 61000-4-3 + A1 + A2 / BS EN 61000-4-3 + A1 + A2 (Radiated, radio-frequency, electromagnetic field test) EN 61000-4-4 + A1 / BS EN 61000-4-4 + A1 (Burst Electrical fast transients/burst test) EN 61000-4-5 / BS EN 61000-4-5 (Surge test) EN 61000-4-6 / BS EN 61000-4-6 (to conducted disturbances, induced by radio- frequency fields) EN 61000-4-8 / BS EN 61000-4-8 (power frequency magnetic field test) EN 61000-6-2 + B1 / BS EN 61000-6-2 + B1 (for industrial environments)
UL Certification	The device CIFX 104C-CO\F and CIFX 104C-CO-R\F are certified according to UL 508	UL-File-Nr. E221530
Configuration	Configuration Software Master and Slave	SYCON.net
	Configuration Software Slave	netX Configuration Tool

Table 149: Technical Data CIFX 104C-CO\F, CIFX 104C-CO-R\F

9.1.27 CIFX 104C-DN, CIFX 104C-DN-R

CIFX 104C-DN, CIFX 104C-DN-R	Parameter	Value
Part	Name, Part No.	CIFX 104C-DN 1270.510
		CIFX 104C-DN-R 1271.510
	Description	PC Card cifX PCI-104 DeviceNet Master or Slave; (for CIFX 104C-DN-R connectors at the left side)
	Function	Communication Interface with PCI-104 and fieldbus interface DeviceNet
Communication Controller	Type	netX 100 processor
Integrated Memory	RAM	8 MB SDRAM
	FLASH	4 MB serial Flash EPROM
	Size of the Dual-Port Memory	64 KByte
System Interface	Bus Type	PCI-104, according to [bus spec 7], refer to section

CIFX 104C-DN, CIFX 104C-DN-R	Parameter	Value
		Overview, page 155.
	Transmission Rate	33 MHz
	Data Access	DPM or DMA (Direct Memory Access)
	Width for the data access to the Dual-Port Memory (DPM)	32-Bit
DeviceNet Communication	Supported communication standard/ protocol (determined by the loaded firmware)	DeviceNet Master, DeviceNet Slave
DeviceNet Interface	Transmission Rate	125 kBit/s, 250 kBit/s, 500 kBit/s
	Interface Type	ISO-11898 according to DeviceNet specification, refer to section <i>DeviceNet Interface</i> , page 142.
	Galvanic Isolation	isolated (optically isolated)
	Isolation Voltage	1000 VDC (tested for 1 minute)
	Connector	CombiCon male Connector, 5-polig
Diagnosis Interface	USB Interface	Mini B USB Plug (5 pin), refer to section <i>Mini-B USB Connector (5 Pin)</i> , page 143.
Display	LED Display	<p>SYS System Status LED</p> <p>MNS Module network status (duo LED)</p> <p>The meaning of the MNS LED is depending on loaded firmware. Refer to chapter <i>Diagnosis with LEDs</i>, page 104..</p>
Power supply	Supply Voltage	+5 V dc ±5 % or +3.3 V dc ±5 %, refer to section <i>Power Supply and Host Interface</i> on page 67.
	Current consumption at 5 V or at 3.3 V.....	500 mA (maximum) 650 mA (maximum)
	Connector	Via PCI-104 Bus
Operation	Rotary Switch PCI-104 Slot Number	To set the PCI-104 Slot Number, refer to section <i>Rotary Switch for PCI-104 Slot Number</i> , page 143.
	Rotary Switch Device Address	Is currently unassigned. Refer to section <i>Rotary Switch Device Address</i> on page 144.
Environmental Conditions	Operating temperature range*	-20 °C ... +70 °C (acc. to UL: 0 °C ... +55 °C)
	*Air flow during measurment	0,5 m/s
	Storage temperature range	-40 °C ... +85 °C
	Humidity	10 ... 95% relative humidity, no condensation permitted
	Environment	For UL compliant usage: The device must be used in a pollution degree 2 environment.
Device	Dimensions (L x W x H)	97 x 91 x 24 mm
	Mounting/Installation	PCI-104 Slot (Supply Voltage 5 V or 3.3 V, Signaling Voltage 5 V or 3.3 V), refer to section <i>Slot for the PC Cards cifX Compact PCI, Mini PCI, Mini PCIe, PCI-104</i> , page 63.
	RoHS	Yes
Compliance with EMC	CE Sign	Yes
	UKCA Sign	Yes
	Emission	EN 55011+ A1, CISPR 11, Class A / BS EN 55011+ A1, CISPR 11, Class A (Radio disturbance characteristics - Limits and methods of measurement)
	Immunity	EN 61000-4-2 / BS EN 61000-4-2 (Electrostatic discharge test) EN 61000-4-3 + A1 + A2 / BS EN 61000-4-3 + A1 + A2

CIFX 104C-DN, CIFX 104C-DN-R	Parameter	Value
		(Radiated, radio-frequency, electromagnetic field test) EN 61000-4-4 + A1 / BS EN 61000-4-4 + A1 (Burst Electrical fast transients/burst test) EN 61000-4-5 / BS EN 61000-4-5 (Surge test) EN 61000-4-6 / BS EN 61000-4-6 (to conducted disturbances, induced by radio- frequency fields) EN 61000-4-8 / BS EN 61000-4-8 (power frequency magnetic field test) EN 61000-6-2 + B1 / BS EN 61000-6-2 + B1 (for industrial environments)
UL Certification	The device CIFX 104C-DN and CIFX 104C-DN-R are certified according to UL 508	UL-File-Nr. E221530
Configuration	Configuration Software Master and Slave	SYCON.net
	Configuration Software Slave	netX Configuration Tool

Table 150: Technical Data CIFX 104C-DN, CIFX 104C-DN-R

9.1.28 CIFX 104C-DN\F, CIFX 104C-DN-R\F

CIFX 104C-DN\F, CIFX 104C-DN-R\F	Parameter	Value	
Part	Name, Part No.	CIFX 104C-DN\F	1270.511
		CIFX 104C-DN-R\F	1271.511
	Description	PC Card cifX PCI-104 DeviceNet Master or Slave composed of: - Basic card CIFX 104C-FB\F or CIFX 104C-FB-R\F* with cable connector Fieldbus X304 (X4) and cable connector DIAG X303 (X3) (*connectors at the left side) - DeviceNet detached network interface (AIFX-DN) and - diagnostic detached network interface (AIFX-DIAG).	
	Function	Communication Interface with PCI-104 and fieldbus interface DeviceNet	
Communication Controller	Type	netX 100 processor	
Integrated Memory	RAM	8 MB SDRAM	
	FLASH	4 MB serial Flash EPROM	
	Size of the Dual-Port Memory	64 KByte	
System Interface	Bus Type	PCI-104, according to [bus spec 7], refer to section <i>Overview</i> , page 155.	
	Transmission Rate	33 MHz	
	Data Access	DPM or DMA (Direct Memory Access)	
	Width for the data access to the Dual-Port Memory (DPM)	32-Bit	
DeviceNet Communication	Supported communication standard/ protocol (determined by the loaded firmware)	DeviceNet Master, DeviceNet Slave	
DeviceNet Interface	Transmission Rate	125 kBit/s, 250 kBit/s, 500 kBit/s	
	Interface Type	ISO-11898 according to DeviceNet specification, refer to section <i>DeviceNet Interface</i> , page 142.	
	DeviceNet detached Network Interface	AIFX-DN, refer to section <i>AIFX-DN</i> , page 222. Important! Operating the PC card CIFX 104C-DN\F or CIFX 104C-DN-R\F requires proper connection of the DeviceNet detached network interface (AIFX-DN) to the basic card!	
	Connector AIFX-DN	Cable Connector Fieldbus X304 (X4) (JST 10FMN-SMT-A-TF(LF)(SN), Pitch 1,0 mm)	
Diagnosis Interface	Diagnostic detached Network Interface	AIFX-DIAG, refer to section <i>AIFX-DIAG</i> , Page 224.	
	Connector AIFX-DIAG	Cable Connector DIAG X303 (X3) (JST 12FMN-SMT-A-TF(LF)(SN), Pitch 1,0 mm)	
Display	LED Display	SYS System Status LED	
		For LED at AIFX-DN, refer to section <i>AIFX-DN</i> , p. 222.	
Power supply	Supply Voltage	+5 V dc $\pm 5\%$ or +3.3 V dc $\pm 5\%$, refer to section <i>Power Supply and Host Interface</i> on page 67.	
	Current consumption at 5 V or at 3.3 V.....	500 mA (maximum)	
	Connector	Via PCI-104 Bus	
Operation	Rotary Switch PCI-104 Slot Number	To set the PCI-104 Slot Number, refer to section <i>Rotary Switch for PCI-104 Slot Number</i> , page 143.	
Environmental Conditions	Operating temperature range*	-20 °C ... +70 °C (acc. to UL: 0 °C ... +55 °C)	
	*Air flow during measurment	0,5 m/s	

CIFX 104C-DNF, CIFX 104C-DN-R\F	Parameter	Value
	Storage temperature range	-40 °C ... +85 °C
	Humidity	10 ... 95% relative humidity, no condensation permitted
	Environment	For UL compliant usage: The device must be used in a pollution degree 2 environment.
Device	Dimensions (L x W x H)	97 x 91 x 24 mm
	Mounting/Installation	PCI-104 Slot (Supply Voltage 5 V or 3.3 V, Signaling Voltage 5 V or 3.3 V), refer to section <i>Slot for the PC Cards cifX Compact PCI, Mini PCI, Mini PCIe, PCI-104</i> , page 63.
	RoHS	Yes
Compliance with EMC	CE Sign	Yes
	UKCA Sign	Yes
	Emission	EN 55011+ A1, CISPR 11, Class A / BS EN 55011+ A1, CISPR 11, Class A (Radio disturbance characteristics - Limits and methods of measurement)
	Immunity	EN 61000-4-2 / BS EN 61000-4-2 (Electrostatic discharge test) EN 61000-4-3 + A1 + A2 / BS EN 61000-4-3 + A1 + A2 (Radiated, radio-frequency, electromagnetic field test) EN 61000-4-4 + A1 / BS EN 61000-4-4 + A1 (Burst Electrical fast transients/burst test) EN 61000-4-5 / BS EN 61000-4-5 (Surge test) EN 61000-4-6 / BS EN 61000-4-6 (to conducted disturbances, induced by radio- frequency fields) EN 61000-4-8 / BS EN 61000-4-8 (power frequency magnetic field test) EN 61000-6-2 + B1 / BS EN 61000-6-2 + B1 (for industrial environments)
UL Certification	The device CIFX104C-DNF and CIFX 104C-DN-R\F are certified according to UL 508	UL-File-Nr. E221530
Configuration	Configuration Software Master and Slave	SYCON.net
	Configuration Software Slave	netX Configuration Tool

Table 151: Technical Data CIFX104C-DNF, CIFX 104C-DN-R\F

9.1.29 CIFX 104C-CC\F

CIFX 104C-CC\F	Parameter	Value
Part	Name	CIFX 104C-CC\F
	Part No.	1270.741
	Description	PC Card cifX PCI-104 CC-Link Slave composed of: - Basic card CIFX 104C-FB\F with cable connector Fieldbus X304 and cable connector DIAG X303, - CC-Link detached network interface (AIFX-CC) and - diagnostic detached network interface (AIFX-DIAG).
	Function	Communication Interface with PCI-104 and fieldbus interface CC-Link
Communication Controller	Type	netX 100 processor
Integrated Memory	RAM	8 MB SDRAM
	FLASH	4 MB serial Flash EPROM
	Size of the Dual-Port Memory	64 KByte
System Interface	Bus Type	PCI-104, according to [bus spec 7], refer to section <i>Overview</i> , page 155.
	Transmission Rate	33 MHz
	Data Access	DPM or DMA (Direct Memory Access)
	Width for the data access to the Dual-Port Memory (DPM)	32-Bit
CC-Link Communication	Supported communication standard/ protocol (determined by the loaded firmware)	CC-Link Slave
CC-Link Interface	Transmission Rate	156 kBit/s, 625 kBit/s, 2500 kBit/s, 5 MBit/s, 10 MBit/s
	Interface Type	RS-485, refer to section <i>CC-Link Interface</i> , page 142.
	CC-Link detached Network Interface	AIFX-CC, refer to section <i>AIFX-CC</i> , page 223. Important! Operating the PC card CIFX 104C-CC\F requires proper connection of the CC-Link detached network interface (AIFX-CC) to the basic card!
	Connector AIFX-CC	Cable Connector Fieldbus X304 (JST 10FMN-SMT-A-TF(LF)(SN), Pitch 1,0 mm)
Diagnosis Interface	Diagnostic detached Network Interface	AIFX-DIAG, refer to section <i>AIFX-DIAG</i> , Page 224.
	Connector AIFX-DIAG	Cable Connector DIAG X303 (JST 12FMN-SMT-A-TF(LF)(SN), Pitch 1,0 mm)
Display	LED Display	SYS System Status LED
		For LEDs at AIFX-CC, refer to section <i>AIFX-CC</i> , p. 223.
Power supply	Supply Voltage	+5 V dc $\pm 5\%$ or +3.3 V dc $\pm 5\%$, refer to section <i>Power Supply and Host Interface</i> on page 67.
	Current consumption at 5 V or at 3.3 V.....	500 mA (maximum) 650 mA (maximum)
	Connector	Via PCI-104 Bus
Operation	Rotary Switch PCI-104 Slot Number	To set the PCI-104 Slot Number, refer to section <i>Rotary Switch for PCI-104 Slot Number</i> , page 143.
Environmental Conditions	Operating temperature range*	0 °C ... +60 °C
	*Air flow during measurement	0,5 m/s
	Storage temperature range	-40 °C ... +85 °C
	Humidity	10 ... 95% relative humidity, no condensation permitted

CIFX 104C-CCIF	Parameter	Value
Device	Dimensions (L x W x H)	97 x 91 x 24 mm
	Mounting/Installation	PCI-104 Slot (Supply Voltage 5 V or 3.3 V, Signaling Voltage 5 V or 3.3 V), refer to section <i>Slot for the PC Cards cifX Compact PCI, Mini PCI, Mini PCIe, PCI-104</i> , page 63.
	RoHS	Yes
Compliance with EMC	CE Sign	Yes
	UKCA Sign	Yes
	Emission	EN 55011+ A1, CISPR 11, Class A / BS EN 55011+ A1, CISPR 11, Class A (Radio disturbance characteristics - Limits and methods of measurement)
	Immunity	EN 61000-4-2 / BS EN 61000-4-2 (Electrostatic discharge test) EN 61000-4-3 + A1 + A2 / BS EN 61000-4-3 + A1 + A2 (Radiated, radio-frequency, electromagnetic field test) EN 61000-4-4 + A1 / BS EN 61000-4-4 + A1 (Burst Electrical fast transients/burst test) EN 61000-4-5 / BS EN 61000-4-5 (Surge test) EN 61000-4-6 / BS EN 61000-4-6 (to conducted disturbances, induced by radio- frequency fields) EN 61000-4-8 / BS EN 61000-4-8 (power frequency magnetic field test) EN 61000-6-2 + B1 / BS EN 61000-6-2 + B1 (for industrial environments)
Configuration	Configuration Software	SYCON.net or netX Configuration Tool

Table 152: Technical Data CIFX104C-CCIF

9.1.30 AIFX-RE

AIFX-RE	Parameter	Value
Part	Name	AIFX-RE
	Part No.	2800.100
	Description	Detached network interface Ethernet for the PC cards CIFX 90-RE\F, CIFX 90E-RE\F, CIFX 90E-RE\NHS\F, CIFX 90E-RE\ET\F, CIFX 90E-RE\MR\F, CIFX 90E-RE\MR\ET\F, CIFX 104C-RE\F, CIFX 104C-RE-R\F
Interface PC Card cifX	Connector	Cable Connector Ethernet X1 (JST SM20B-SRSS-TB(LF)(SN), Pitch 1.0 mm)
Ethernet Interface	Galvanic Isolation	isolated
	Isolation Voltage	1000 VDC (tested for 1 minute)
	Connector	2* RJ45 Socket
Display	LED Display (on the reverse side of the device)	The meaning of the following LEDs depends on the loaded firmware:: COM 0 LED Communication Status 0 (duo LED) COM 1 LED Communication Status 1 (duo LED) LED yellow at RJ45Ch0 and RJ45Ch1, for Ethernet Link status, Ethernet Activity status and additional status LED green Refer to chapter <i>Diagnosis with LEDs</i> , page 104.
Power supply	Connector	Cable Connector Ethernet X1
Environmental Conditions	Operating temperature range*	From hardware revision 3: -40 °C ... +85 °C Hardware revision 1 and 2: 0 °C ... +70 °C
	*Air flow during measurement	0,5 m/s
	Storage temperature range	-40 °C ... +85 °C
	Humidity	10 ... 95% relative humidity, no condensation permitted
	Environment	For UL compliant usage: The device must be used in a pollution degree 2 environment.
Device	Dimensions (L x W x H)	30,7 x 42,3 x 18,5 mm (H = width of the front panel)
	Mounting/Installation	At the basic cards CIFX 90, CIFX 90E, CIFX 90E\NHS, CIFX 90E\ET, CIFX 90E\MR, CIFX 90E\MR\ET: Cable Connector Ethernet X4; or at CIFX 104C-RE\F, CIFX 104C-RE-R\F: Cable Connector Ethernet X304 (X4)
	RoHS	Yes
Compliance with EMC	CE Sign	Yes
	UKCA Sign	Yes
	Emission, Immunity	Tested together with the corresponding basic cards cifX.
UL Certification	The device AIFX-RE is certified according to UL 508	UL-File-Nr. E221530

Table 153: Technical Data AIFX-RE

9.1.31 AIFX-RE\M12

AIFX-REM12	Parameter	Value
Part	Name, Part No.	AIFX-RE\M12 2800.101
	Description	Detached network interface Ethernet for the PC cards CIFX 90-RE\F\M12, CIFX 90E-RE\F\M12, CIFX 90E-RE\NHS\F\M12, CIFX 90E-RE\ET\F\M12, CIFX 90E-RE\MR\F, CIFX 90E-RE\MR\ET\F\M12, CIFX 104C-RE\F\M12, CIFX 104C-RE-R\F\M12
Interface PC Card cifX	Connector	Cable Connector Ethernet X2 (JST SM20B-SRSS-TB(LF)(SN), Pitch 1.0 mm)
Ethernet Interface	Galvanic Isolation	isolated
	Isolation Voltage	1000 VDC (tested for 1 minute)
	Connector	2* M12 Socket
Display <i>Alternative use:</i> 1. LED displays via the lightpipe or 2. LED signals via cable connector LED Signals X3	LED Display (via lightpipe)	The meaning of the following LEDs depends on the loaded firmware: COM 0 LED Communication Status 0 (duo LED) COM 1 LED Communication Status 1 (duo LED) LED yellow Ch0 and Ch1 Ethernet Link status, LED green Ethernet Activity status and additional status Refer to chapter <i>Diagnosis with LEDs</i> , page 104.
	Cable connector LED Signals X3	Signals for the communication LEDs COM0 and COM1 (each green/red), or the Ethernet LEDs Ch0 and Ch1 Ethernet link status (green), Ethernet activity status (yellow) and other statuses green or yellow. The meaning of the LEDs connected via the signals depends on the loaded firmware. For pin assignment of the LED signals see section Pin Assignment Cable Connector LED Signals X3, AIFX-REM12 on page 150. Maximum current consumption for the individual LEDs: 5 mA
Power supply	Connector	Cable Connector Ethernet X2
Environmental Conditions	Operating temperature range*	-30 °C ... +70 °C
	*Air flow during measurment	0,5 m/s
	Storage temperature range	-40 °C ... +85 °C
	Humidity	10 ... 95% relative humidity, no condensation permitted
Device	Dimensions (L x W x H)	60 x 36 x 15,5 mm
	Mounting/Installation	At the basic cards CIFX 90, CIFX 90E, CIFX 90E\NHS, CIFX 90E\ET, CIFX 90E\MR, CIFX 90E\MR\ET: Cable Connector Ethernet X4; or at CIFX 104C-RE\F, CIFX 104C-RE-R\F: Cable Connector Ethernet X304 (X4)
	RoHS	Yes
Compliance with EMC	CE Sign	Yes
	UKCA Sign	Yes
	Emission, Immunity	Tested together with the corresponding basic cards cifX.

Table 154: Technical Data AIFX-REM12

9.1.32 AIFX-DP

AIFX-DP	Parameter	Value
Part	Name	AIFX-DP
	Part No.	2800.400
	Description	PROFIBUS detached network interface for the PC cards CIFX 90-DP\F, CIFX 90E-DP\F, CIFX 90E-DP\NHS\F, CIFX 90E-DP\ET\F, CIFX 90E-DP\MR\F, CIFX 90E-DP\MR\ET\F, CIFX 90E-2DP\ET\F, CIFX 90E-2DP\MR\ET\F, CIFX 90E-2DP\CO\ET\F, CIFX 90E-2DP\CO\MR\ET\F, CIFX 90E-2DP\DN\ET\F, CIFX 90E-2DP\DN\MR\ET\F, CIFX 104C-DP\F, CIFX 104C-DP-R\F
Interface PC Card cifX	Connector	Cable Connector Fieldbus X1 (JST 10FMN-SMT-A-TF(LF)(SN), Pitch 1,0 mm)
PROFIBUS Interface	Galvanic Isolation	isolated
	Isolation Voltage	1000 VDC (tested for 1 minute)
	Connector	DSub female Connector, 9 pin
Display	LED Display (on the reverse side of the device)	The meaning of the following LEDs depends on the loaded firmware: ERR LED Error status (red) STA LED Status (green) For PROFIBUS MPI the STA LED is not used. Refer to chapter <i>Diagnosis with LEDs</i> , page 104.
Power supply	Connector	Cable Connector Fieldbus X1
Environmental Conditions	Operating temperature range*	-20 °C ... +70 °C
	*Air flow during measurement	0,5 m/s
	Storage temperature range	-40 °C ... +85 °C
	Humidity	10 ... 95% relative humidity, no condensation permitted
	Environment	For UL compliant usage: The device must be used in a pollution degree 2 environment.
Device	Dimensions (L x W x H)	17 x 31 x 18,5 mm (H = width of the front panel)
	Mounting/Installation	At the basic cards CIFX 90, CIFX 90E, CIFX 90E\NHS, CIFX 90E\ET, CIFX 90E\MR, CIFX 90E\MR\ET: Cable Connector Fieldbus X3; or at CIFX 104C-FB\F, CIFX 104C-FB-R\F: Cable Connector Fieldbus X304 (X4)
	RoHS	Yes
Compliance with EMC	CE Sign	Yes
	UKCA Sign	Yes
	Emission, Immunity	Tested together with the corresponding basic cards cifX.
UL Certification	The device AIFX-DP is certified according to UL 508	UL-File-Nr. E221530

Table 155: Technical Data AIFX-DP

9.1.33 AIFX-CO

AIFX-CO	Parameter	Value
Part	Name	AIFX-CO
	Part No.	2800.500
	Description	CANopen detached network interface for the PC cards CIFX 90-CO\F, CIFX 90E-CO\F, CIFX 90E-CO\NHS\F, CIFX 90E-CO\ET\F, CIFX 90E-CO\MR\F, CIFX 90E-CO\MR\ET\F, CIFX 90E-2DP\CO\ET\F, CIFX 90E-2DP\CO\MR\ET\F, CIFX 90E-2CO\ET\F, CIFX 90E-2CO\MR\ET\F, CIFX 90E-2CO\DN\ET\F, CIFX 90E-2CO\DN\MR\ET\F, CIFX 104C-CO\F, CIFX 104C-CO-R\F
Interface PC Card cifX	Connector	Cable Connector Fieldbus X1 (JST 10FMN-SMT-A-TF(LF)(SN), Pitch 1,0 mm)
CANopen Interface	Galvanic Isolation	isolated (optically isolated)
	Isolation Voltage	1000 VDC (tested for 1 minute)
	Connector	DSub male Connector, 9 pin
Display	LED Display (on the reverse side of the device)	The meaning of the following LEDs depends on the loaded firmware:: ERR LED Error status (red) RUN LED Run (green) Refer to chapter <i>Diagnosis with LEDs</i> , page 104.
Power supply	Connector	Cable Connector Fieldbus X1
Environmental Conditions	Operating temperature range*	-20 °C ... +70 °C
	*Air flow during measurement	0,5 m/s
	Storage temperature range	-40 °C ... +85 °C
	Humidity	10 ... 95% relative humidity, no condensation permitted
	Environment	For UL compliant usage: The device must be used in a pollution degree 2 environment.
Device	Dimensions (L x W x H)	17 x 31 x 18,5 mm (H = width of the front panel)
	Mounting/Installation	At the basic cards CIFX 90, CIFX 90E, CIFX 90E\NHS, CIFX 90E\ET, CIFX 90E\MR, CIFX 90E\MR\ET: Cable Connector Fieldbus X3; or at CIFX 104C-FB\F, CIFX 104C-FB-R\F: Cable Connector Fieldbus X304 (X4)
	RoHS	Yes
Compliance with EMC	CE Sign	Yes
	UKCA Sign	Yes
	Emission, Immunity	Tested together with the corresponding basic cards cifX.
UL Certification	The device AIFX-CO is certified according to UL 508	UL-File-Nr. E221530

Table 156: Technical Data AIFX-CO

9.1.34 AIFX-DN

AIFX-DN	Parameter	Value
Part	Name	AIFX-DN
	Part No.	2800.510
	Description	DeviceNet detached network interface for the PC cards CIFX 90-DNF, CIFX 90E-DNF, CIFX 90E-DN\NHS\F, CIFX 90E-DN\ET\F, CIFX 90E-DN\MR\F, CIFX 90E-DN\MR\ET\F, CIFX 90E-2DP\DN\ET\F, CIFX 90E-2DP\DN\MR\ET\F, CIFX 90E-2CO\DN\ET\F, CIFX 90E-2CO\DN\MR\ET\F, CIFX 90E-2DN\ET\F, CIFX 90E-2DN\MR\ET\F, CIFX 104C-DNF, CIFX 104C-DN-R\F
Interface PC Card cifX	Connector	Cable Connector Fieldbus X1 (JST 10FMN-SMT-A-TF(LF)(SN), Pitch 1,0 mm)
DeviceNet Interface	Galvanic Isolation	isolated (optically isolated)
	Isolation Voltage	1000 VDC (tested for 1 minute)
	Connector	CombiCon male Connector, 5-polig
Display	LED Display (on the reverse side of the device)	MNS Module network status (duo LED) The meaning of the MNS LED is depending on loaded firmware. Refer to chapter <i>Diagnosis with LEDs</i> , page 104.
Power supply	Connector	Cable Connector Fieldbus X1
Environmental Conditions	Operating temperature range*	-20 °C ... +70 °C
	*Air flow during measurment	0,5 m/s
	Storage temperature range	-40 °C ... +85 °C
	Humidity	10 ... 95% relative humidity, no condensation permitted
	Environment	For UL compliant usage: The device must be used in a pollution degree 2 environment.
Device	Dimensions (L x W x H)	23,7 x 31 x 18,5 mm (L = 23,7, without CombiCon male Connector; H = width of the front panel)
	Mounting/Installation	At the basic cards CIFX 90, CIFX 90E, CIFX 90E\NHS, CIFX 90E\ET, CIFX 90E\MR, CIFX 90E\MR\ET: Cable Connector Fieldbus X3; or at CIFX 104C-FB\F, CIFX 104C-FB-R\F: Cable Connector Fieldbus X304 (X4)
	RoHS	Yes
Compliance with EMC	CE Sign	Yes
	UKCA Sign	Yes
	Emission, Immunity	Tested together with the corresponding basic cards cifX.
UL Certification	The device AIFX-DN is certified according to UL 508	UL-File-Nr. E221530

Table 157: Technical Data AIFX-DN

9.1.35 AIFX-CC

AIFX-CC	Parameter	Value
Part	Name	AIFX-CC
	Part No.	2800.730
	Description	CC-Link detached network interface for the PC cards CIFX 90E-CC\NHS\F, CIFX 90E-CC\ET\F, CIFX 90E-CC\MR\ET\F, CIFX 104C-CC\F
Interface PC Card cifX	Connector	Cable Connector Fieldbus X1 (JST 10FMN-SMT-A-TF(LF)(SN), Pitch 1,0 mm)
CC-Link Interface	Galvanic Isolation	isolated (optically isolated)
	Isolation Voltage	1000 VDC (tested for 1 minute)
	Connector	CombiCon male Connector, 5-polig
Display	LED Display (on the reverse side of the device)	L RUN LED L Run (Duo-LED) L ERR LED L Error (Duo-LED) Refer to chapter <i>Diagnosis with LEDs</i> , page 104.
Power supply	Connector	Cable Connector Fieldbus X1
Environmental Conditions	Operating temperature range*	0 °C ... +60 °C
	*Air flow during measurment	0,5 m/s
	Storage temperature range	-40 °C ... +85 °C
	Humidity	10 ... 95% relative humidity, no condensation permitted
	Environment	For UL compliant usage: The device must be used in a pollution degree 2 environment.
Device	Dimensions (L x W x H)	43,2 x 31 x 18,5 mm (L = 43,2, without CombiCon male Connector; H = width of the front panel)
	Mounting/Installation	At the basic cards CIFX 90, CIFX 90E, CIFX 90E\NHS, CIFX 90E\ET, CIFX 90E\MR, CIFX 90E\MR\ET: Cable Connector Fieldbus X3; or at CIFX 104C-FB\F: Cable Connector Fieldbus X304 (X4)
	RoHS	Yes
Compliance with EMC	CE Sign	Yes
	UKCA Sign	Yes
	Emission, Immunity	Tested together with the corresponding basic cards cifX.
UL Certification	The device is certified according to UL 508	UL-File-Nr. E221530

Table 158: Technical Data AIFX-CC

9.1.36 AIFX-DIAG

AIFX-DIAG	Parameter	Value
Part	Name	AIFX-DIAG
	Part No.	2800.000
	Description	Diagnostic detached network interface for the PC cards CIFX 104C-RE\F, CIFX 104C-RE-R\F, CIFX 104C-RE\F\M12, CIFX 104C-RE-R\F\M12, CIFX 104C-DP\F, CIFX 104C-DP-R\F, CIFX 104C-CO\F, CIFX 104C-CO-R\F, CIFX 104C-DN\F, CIFX 104C-DN-R\F, CIFX 104C-CC\F
Interface PC Card cifX	Connector	Cable Connector DIAG X1 (JST 12FMN-SMT-A-TF(LF)(SN), Pitch 1,0 mm)
Diagnosis Interface	USB Interface	Mini B USB Plug (5 pin), refer to section <i>Mini-B USB Connector (5 Pin)</i> , page 143.
Display	LED Display	PWR Supply Voltage ON LED SYS System Status LED The meaning of the following LEDs depends on the loaded firmware:: COM 0 LED Communication Status 0 (duo LED) COM 1 LED Communication Status 1 (duo LED) Refer to chapter <i>Diagnosis with LEDs</i> , page 104.
Power supply	Connector	Cable Connector DIAG X1
Operation	Rotary Switch Device Address	Is currently unassigned. Refer to section <i>Rotary Switch Device Address</i> on page 144.
Environmental Conditions	Operating temperature range*	-20 °C ... +70 °C
	*Air flow during measurement	0,5 m/s
	Storage temperature range	-40 °C ... +85 °C
	Humidity	10 ... 95% relative humidity, no condensation permitted
	Environment	For UL compliant usage: The device must be used in a pollution degree 2 environment.
Device	Dimensions (L x W x H)	20,5 x 52,7 x 18,5 mm (H = width of the front panel)
	Mounting/Installation	At the basic cards CIFX 104C-RE\F, CIFX 104C-RE-R\F, CIFX 104C-FB\F, CIFX 104C-FB-R\F Cable Connector DIAG X303 (X3)
	RoHS	Yes
Compliance with EMC	CE Sign	Yes
	UKCA Sign	Yes
	Emission, Immunity	Tested together with the corresponding basic card cifX..
UL Certification	The device AIFX-DIAG is certified according to UL 508	UL-File-Nr. E221530

Table 159: Technical Data AIFX-DIAG

9.2 PCI IDs PC Cards cifX on the PCI Bus

On the PCI bus the PC Cards cifX have the following PCI IDs:

PCI IDs	Value
VendorID	0x15CF
DeviceID	0x0000
Subsystem Vendor ID	0x0000
Subsystem Device ID	0x0000

Table 160: PCI IDs PC Cards cifX on the PCI Bus

9.3 Supported PCI Bus Commands

From the following table you can see which PCI bus commands are supported by the Hilscher PC Cards cifX *Compact PCI*, *Mini PCI*, *Mini PCI Express* and *PCI-104*.

C/BE3#	C/BE2#	C/BE1#	C/BE0#	Command Type	supported
0	0	0	0	Interrupt Acknowledge	no
0	0	0	1	Special Cycle	no
0	0	1	0	I/O Read	✓
0	0	1	1	I/O Write	✓
0	1	0	0	Reserved	no
0	1	0	1	Reserved	no
0	1	1	0	Memory Read	✓
0	1	1	1	Memory Write	✓
1	0	0	0	Reserved	no
1	0	0	1	Reserved	no
1	0	1	0	Configuration Read	✓
1	0	1	1	Configuration Write	✓
1	1	0	0	Memory Read Multiple	no
1	1	0	1	Dual Address Cycle	no
1	1	1	0	Memory Read Line	no
1	1	1	1	Memory Write and Invalidate	no

Table 161: Supported / not supported PCI Bus Commands

C/BE = Bus Command and Byte Enable Signal of PCI

9.4 Technical Data of the Communication Protocols

9.4.1 CC-Link IE Field Basic Slave

Parameter	Description
Maximum number of cyclic input data	RY data: 128 bytes (1024 bits) RWw data: 512 words (16 bit)
Maximum number of cyclic output data	RX data: 128 bytes (1024 bits) RWr data: 512 words (16 bit)
Occupied stations	1 ... 16 (1 station has 64 bits RY data, 32 words RWw data, 64 bits RX data, and 32 words RWr data.)
Acyclic communication	SLMP Server and Client
Data transport layer	Ethernet II, IEEE 802.3
Baud rate	100 MBit/s
Reference to firmware / stack version	V1.1
Ports	
Cyclic data	61450 (UDP)
Discovery and SLMP Server	61451 (UDP)
SLMP Parameter	45237 (UDP)
SLMP Communication	20000 (UDP)

Table 162: Technical data CC-Link IE Field Basic Slave protocol

9.4.2 EtherCAT Master

Parameter	Description
Maximum number of EtherCAT slaves	Maximum of 388 slaves, if RCX_GET_SLAVE_HANDLES_REQ service is used for determining number of slaves. The number of usable slaves depends on several parameters: the available memory for the configuration file (see 'configuration file' below), used cycle time, frame propagation time.
Maximum number of cyclic input data	Appr. 4600 bytes, if no LRW command (Logical Read Write) is used for process data
Maximum number of cyclic output data	Appr. 4600 bytes, if no LRW command (Logical Read Write) is used for process data
Acyclic communication	CoE (CANopen over EtherCAT): SDO, SDOINFO, Emergency FoE (File Access over EtherCAT) SoE (Servo Drive Profile over EtherCAT) EoE (Ethernet over EtherCAT) Configurable with SYCON.net: CoE If the file ETHERCAT.XML contains the appropriate configuration information (e.g. created with "EtherCAT Configurator"), following functions can be used: CoE, SoE, EoE
Mailbox protocols	CoE, EoE, FoE, SoE
Functions	Distributed Clocks Redundancy Slave diagnostics Bus scan
Minimum bus cycle time	250 µs, depending on the used number of slaves and the used number of cyclic input data and output data.
Topology	Line or ring
Slave station address range	1 – 14335
Data transport layer	Ethernet II, IEEE 802.3, 100 MBit/s, full-duplex
Configuration file (ETHERCAT.XML or CONFIG.NXD)	Maximum 1 MByte
Synchronization via ExtSync	Supported (not configurable with SYCON.net)
ENI Slave-to-Slave copy infos	Supported (not configurable with SYCON.net)
Hot Connect	Supported (not configurable with SYCON.net)
EoE (Ethernet over EtherCAT)	Via NDIS
Limitations	The size of the bus configuration file is limited by the size of the RAM disk (1 MByte) or Flash disk (3 MByte). Store-and-forward switches cannot be used within network topology due to hard receive timing model RCX_GET_SLAVE_HANDLES_REQ can only communicate up to 388 slaves. Process data is restricted by the dual-port memory to 5760 bytes.
Reference to firmware / stack version	V4.4

Table 163: Technical Data EtherCAT Master Protocol

9.4.3 EtherCAT Slave

Parameter	Description
Maximum number of cyclic input data	256* bytes
Maximum number of cyclic output data	256* bytes
Acyclic communication	SDO SDO Master-Slave SDO Slave-Slave (depending on Master capability)
Type	Complex Slave
Functions	Emergency
FMMUs	3
SYNC Manager	4
Distributed Clocks (DC)	Supported, 32 Bit
Baud rate	100 MBit/s
Data transport layer	Ethernet II, IEEE 802.3
Limitation	LRW is not supported
Reference to firmware/stack version	V2.5 and V4.7

Table 164: Technical Data EtherCAT Slave Protocol



Note: * The loadable firmware supports for the number of cyclic input data and for cyclic output data in total up to 512 bytes. If more than 256 bytes for input data or for output data shall be exchanged via EtherCAT, then a customer specific XML file is necessary. Additionally the following formula applies: The sum of the input data length and the output data length may not exceed 512 bytes, where each length has to be rounded up to the next multiple of 4 for this calculation.

9.4.4 EtherNet/IP Scanner (Master)

Parameter	Description
Maximum number of EtherNet/IP connections	64 connections for implicit and explicit
Maximum number of total cyclic input data	5712 bytes
Maximum number of total cyclic output data	5760 bytes
Maximum number of cyclic input data	504 bytes per slave per telegram
Maximum number of cyclic output data	504 bytes per slave per telegram
IO Connection type	Cyclic, minimum 1 ms (depending on used number of connections and used number of input and output data)
Maximum number of unscheduled data	1400 bytes per telegram
UCMM, Class 3	Supported
Explicit Messages, Client and Server Services	Get_Attribute_Single/All Set_Attribute_Single/All
Quick connect	Supported
Predefined standard objects	Identity Object Message Route Object Assembly Object Connection Manager Ethernet Link Object TCP/IP Object DLR Object QoS Object
Maximal number of user specific objects	20
Network scan	Supported
Topology	Tree, Line, Ring
DLR (Device Level Ring)	Beacon based 'Ring Node'
ACD (Address Conflict Detection)	Supported
DHCP	Supported
BOOTP	Supported
Baud rates	10 and 100 MBit/s
Data transport layer	Ethernet II, IEEE 802.3
Switch function	Integrated
Limitations	CIP Sync Services are not implemented TAGs are not supported
Reference to firmware/stack version	V2.10

Table 165: Technical Data EtherNet/IP Scanner Protocol

9.4.5 EtherNet/IP Adapter (Slave)

Parameter	Description
Maximum number of input data	504 bytes per assembly instance
Maximum number of output data	504 bytes per assembly instance
Maximum number of assembly instances	10
IO connection types (implicit)	Exclusive Owner Listen Only Input Only
IO Connection trigger types	Cyclic (minimum 1 ms*) Application Triggered (minimum 1 ms*) Change Of State (minimum 1 ms*) * depending on number of connections and number of input and output data
Explicit Messages	Connected and unconnected
Unconnected Message Manager (UCMM)	Supported
Maximum number of connections	Implicit connections (Class 1): 5 Explicit connections (Class 3): 10 UCMM: 10
Predefined standard objects	Identity object (1, 0x01) Message Router object (2, 0x02) Assembly object (4, 0x04) Connection Manager (6, 0x06) DLR object (71, 0x47) QoS object (72, 0x48) TCP/IP object (245, 0xF5) Ethernet Link object (246, 0xF6)
Maximum number of user specific objects	20
Supported functions, protocols and, services	TCP/IP, UDP/IP DHCP, BOOTP Quick Connect Device Level Ring (DLR) - Media Redundancy Address Conflict Detection (ACD) Quality of Service CIP Reset services - Identity Object Reset Service (Type 0 and 1)
Ethernet interface	10 and 100 MBit/s Integrated switch
Duplex modes	Half duplex, Full duplex, Auto negotiation
MDI modes	MDI, MDI-X, Auto-MDIX
Data transport layer	Ethernet II, IEEE 802.3
Limitations	Tags are not supported. Connection type "Null forward Open" is not supported. CIP Motion is not supported. CIP Safety is not supported.
Reference to firmware/stack version	V3.6

Table 166: Technical Data EtherNet/IP Adapter protocol

9.4.6 Open Modbus/TCP

Parameter	Description
Maximum number of input data	2880 Registers
Maximum number of output data	2880 Registers
Acyclic communication	Read/Write Register: - Maximum 125 Registers per Read Telegram (FC 3, 4, 23), - Maximum 121 Registers per Write Telegram (FC 23), - Maximum 123 Registers per Write Telegram (FC 16) Read/Write Coil: - Maximum 2000 Coils per Read Telegram (FC 1, 2), - Maximum 1968 Coils per Write Telegram (FC 15)
Modbus Function Codes	1, 2, 3, 4, 5, 6, 7, 15, 16, 23*, 43 * Function Code 23 can be used via the packet API, but not with the Command Table.
Protocol Mode	Message Mode (Client Mode): - Client (using the Command Table: The data is stored in the I/O process data image) - Client (using the packet API: The I/O process data image is not used) - Server (using the packet API: The I/O process data image is not used) I/O Mode (Server Mode): - Server (only) (The data is stored in the I/O process data image)
Command table (Configuration API only)	Max. 16 servers configurable Max. 256 commands
Baud rates	10 and 100 MBit/s
Data transport layer	Ethernet II, IEEE 802.3
Reference to firmware/stack version	V2.6

Table 167: Technical Data Open Modbus/TCP Protocol

9.4.7 POWERLINK Controlled Node/Slave

Parameter	Description
Maximum number of cyclic input data	1490 bytes
Maximum number of cyclic output data	1490 bytes
Acyclic data transfer	SDO Upload/Download
Functions	SDO over ASND and UDP
Baud rate	100 MBit/s, half-duplex
Data transport layer	Ethernet II, IEEE 802.3
Ethernet POWERLINK version	V 2
Limitation	No slave to slave communication
Reference to firmware/stack version	V3.4

Table 168: Technical Data POWERLINK Controlled Node Protocol

9.4.8 PROFINET IO-Controller

Parameter	Description
Maximum number of ARs (Application Relation)	128 for RT communication 64 for IRT communication
Maximum number of cyclic input data	5652 bytes, including provider and consumer status
Maximum number of cyclic output data	5700 bytes, including provider and consumer status
Send clock	1 ms, 2 ms, 4 ms for RT mode 250 µs, 500 µs, 1 ms, 2 ms, 4 ms for IRT mode
Performance limits of ARs	Max. 8 ARs, if a send clock < 500 µs Max. 16 ARs, if a send clock < 1 ms Max. 64 ARs, if a send clock < 2 ms
Maximum number of submodules	2048
Maximum amount of data per IOCR	1440 bytes
Number of IOCRs per AR	1 Input IOCR 1 Output IOCR
Maximum amount of data for acyclic read/write record access	65536 bytes
Maximum amount of record data per AR	16384 bytes
Alarm processing (configurable)	Stack processes alarms automatically Applikation processes alarms
Maximum number of ARVendorBlock	256
Maximum size of ARVendorBlockData	512 bytes
Device Access AR CMI Timeout	20 s
Functions	Automatic Name Assignment Media Redundancy Client Media Redundancy Manager (requires license)
DCP function API	Name Assignment IO-Devices (DCP SET NameOfStation) Set IO-Devices IP (DCP SET IP) Signal IO-Device (DCP SET SIGNAL) Reset IO-Device to factory settings (DCP Reset FactorySettings) Bus scan (DCP IDENTIFY ALL) DCP GET
PROFINET specification	Implemented according to V2.3 ED2 MU3 Legacy Startup supported according to PROFINET specification V2.2

Parameter	Description
Limitations	<p>The size of the bus configuration file is limited by the size of the RAM Disk (1 Mbyte)</p> <p>The usable (minimum) cycle time depends on the number of used IO Devices, the number of used input and output data.</p> <p>RT over UDP not supported</p> <p>Multicast communication not supported</p> <p>DHCP is not supported (neither for PROFINET IO Controller nor for IO-Devices)</p> <p>Only one IOCR per IO-Device per direction</p> <p>One instance of DeviceAccess AR can be used at the same time only</p> <p>MRPD is not supported</p> <p>Planning of IRT is not done by the PROFINET IO Controller protocol stack</p> <p>Sync Slave is not supported</p> <p>One fragmented acyclic services can be used at the same time only</p> <p>Multiple MRP Managers are not supported</p> <p>One DCP Service can be used in parallel only</p> <p>Multiple Sync Masters are not supported</p>
Reference to firmware / stack version	V3.3

Table 169: Technical Data PROFINET IO Controller Protocol

9.4.9 PROFINET IO-Device

Parameter	Description
Maximum number of cyclic input data	1440 bytes (including IOPS and IOCS)12 bytes
Maximum number of cyclic output data	1440 bytes (including IOPS and IOCS)
Maximum number of submodules	<p>Depends on the firmware, can be configured via “Number of configurable submodules” in tag list. Up to 256 in general and may be smaller number for specific firmware.</p> <p>Note: If the application uses max. 2 APIs, the “Number of configurable submodules” can be used. Each further API reduces the total number of usable submodules by 1.</p>
Multiple Application Relations (AR)	<p>Depends on the firmware, can be configured via “Number of additional IO Connections (ARs)” in tag list.</p> <p>Up to 4 IO-ARs and one Supervisor-DA AR in general and may be smaller for numbers specific firmware.</p>
Acyclic communication (Record objects)	Read/Write Record, max supported size can be configured via taglist.
Alarm types	Process Alarm, Diagnostic Alarm, Return Of Submodule Alarm, Plug Alarm (implicit), Pull Alarm (implicit), Update Alarm, Status Alarm, Upload and Retrieval Notification Alarm
Diagnosis entries	<p>Depends on the firmware, can be configured via “Number of available Diagnosis buffers” in tag list.</p> <p>Up to 256 application diagnosis records of type Channel or Extended Channel Diagnosis in general and may be smaller number for specific firmware.</p>
Identification & Maintenance (I&M)	<p>I&M0 Read: Either integrated for slot 0 / subslot 1 or forwarded to the application for each submodule.</p> <p>I&M1-5 Read/Write: Either built in for Slot 0 / Subslot 1 or pass through to application for any submodule. I&M4 and I&M5 are inactive by default.</p>
Topology recognition	LLDP, SNMP V1, Physical Device Record Objects
Minimum cycle time (MinDeviceInterval)	<p>RT_CLASS_1: 1 ms (min. SendClockFactor 32)</p> <p>RT_CLASS_3: 250 µs (min. SendClockFactor 8)</p>
IRT support	RT_CLASS_3

Parameter	Description
Media redundancy	MRP Client
Additional supported features	"Shared Device" Asset Management PROFInergy ASE
Baud rate	100 MBit/s
Data transport layer	Ethernet II, IEEE 802.3, MAUType 16
PROFINET IO specification	V2.3, PNIO_version 2.35 V2.2 ("legacy startup") is supported
Conformance Class	C
Application IP stack API	The lwIP IP stack can be used by the application via Socket API Packets. Up to 8 sockets are available to the Application.
Application Raw Ethernet API	Sending and Receiving Raw Ethernet Frames as Application is supported
Restrictions	RT over UDP not supported. Multicast communication not supported. DHCP is not supported. The amount of configured I/O-data influences the minimum cycle time that can be reached. Only 1 Input-CR and 1 Output-CR per AR are supported. Little endian byte order not supported. System Redundancy (SR-AR) and Dynamic Reconfiguration are not supported. The usage of PROFINET CombinedObjectContainer is not supported. SharedInput is not supported. MRPD is not supported. DFP and other HighPerformance-profile related features are not supported. Submodules cannot be configured or used by an AR in subslot 0. The stack does not support usage of PDEV submodules (InterfaceSubmodule or PortSubmodule) outside of slot 0. In addition the InterfaceSubmodule is only supported in subslot 0x8000 and the PortSubmodules are only supported in subslots 0x8001 and 0x8002.
Reference to stack version	V4.5

Table 170: Technical Data PROFINET IO-Device protocol

The maximum values for number of submodules, Multiple Application Relations, Acyclic communication, and Diagnosis entries are configuration parameters in the tag list of a firmware. Each of these features require resources and have to be set in order to not exceed the available resource (e.g. RAM) of a device.

9.4.10 Sercos Master

Parameter	Description
Maximum number of cyclic input data	5760 bytes (including Connection Control per Connection)
Maximum number of cyclic output data	5760 bytes (including Connection Control per Connection)
Maximum number of configured slave devices	511
Minimum cycle time	250 µs
Acyclic communication	Service channel: Read/Write/Commands
Functions	Bus Scan
Communication phases	NRT, CP0, CP1, CP2, CP3, CP4
Topology	Line and double ring
Redundancy	supported
NRT channel	supported
Hot-Plug	supported
Cross Communication	supported, but only if the master is configured by the host application program by packets.
Baud rate	100 MBit/s, full duplex
Data transport layer	Ethernet II, IEEE 802.3
Auto crossover	supported
Supported Sercos version	Communication Specification Version 1.3
TCP/IP stack	integrated
Reference to firmware/stack version	V2.1

Table 171: Technical Data Sercos Master Protocol

9.4.11 Sercos Slave

Parameter	Description
Maximum number of cyclic produced data	132 bytes (including Connection Control and IO Status)
Maximum number of cyclic consumed data	124 bytes (including Connection Control and IO Status)
Maximum number of slave devices	8
Sercos addresses	1 ... 511
Minimum cycle time	250 µs
Topology	Line and ring
Communication phases	NRT, CP0, CP1, CP2, CP3, CP4, HP0, HP1, HP2
Descriptors for connections (including Connection Control and IO Status/Control)	Max. 64
Acyclic Communication (Service Channel)	Read/Write/Standard Commands
Cross Communication (CC)	Supported
Baud rate	100 MBit/s
Data transport layer	Ethernet II, IEEE 802.3
Supported Sercos version	Communication Specification Version 1.1.2 and 1.3.1
Supported Sercos Communication Profiles	SCP_FixCFG Version 1.1.1 SCP_VarCFG Version 1.1.1 SCP_VarCFG Version 1.1.3 SCP_HP Version 1.1.1 SCP_SysTime Version 1.3
Supported User SCP Profiles	SCP_WD Version 1.1.1 SCP_Diag Version 1.1.1 SCP_RTb Version 1.1.1 SCP_Mux Version 1.1.1 SCP_Sig 1.1.1 SCP_ExtMuX 1.1.2 SCP_RTbListProd 1.3 SCP_RTbListCons 1.3 SCP_RTbWordProd 1.3 SCP_RTbWordCons 1.3 SCP_OvSBasic 1.3 SCP_WDCon 1.3
Supported FSP profiles	FSP_IO FSP_Drive FSP_Encoder
SCP Sync	Supported
SCP_NRT	Supported
S/IP	Supported
Identification LED	Supported
Storage location of object dictionary	Mixed mode
Limitations	Max. 2 connections: 1 for consumer and 1 for producer Modifications of the Service-Channel Object Dictionary will be volatile after reset (if it resides on device)
Reference to firmware/stack version	V3.5

Table 172: Technical Data Sercos Slave Protocol

9.4.12 VARAN Client (Slave)

Parameter	Description
Maximum number of cyclic input data	128 bytes
Maximum number of cyclic output data	128 bytes
Memory Area	Read Memory Area 1, Write Memory Area 1, Read Memory Area 2, Write Memory Area 2
Functions	Memory Read Memory Write
Integrated 2 port splitter for daisy chain topology	Supported
Baud rate	100 MBit/s
Data transport layer	Ethernet II, IEEE 802.3
VARAN protocol version	1.1.1.0
Limitations	Integrated EMAC for IP data exchange with client application not supported SPI single commands (optional feature) not supported
Reference to firmware/stack version	V1.1

Table 173: Technical Data VARAN Client Protocol

9.4.13 PROFIBUS DP Master

Parameter	Description
Maximum number of PROFIBUS DP slaves	125 (DPV0/DPV1)
Maximum number of total cyclic input data	5712 bytes
Maximum number of total cyclic output data	5760 bytes
Maximum number of cyclic input data	244 bytes per slave
Maximum number of cyclic output data	244 bytes per slave
Configuration data	Max. 244 bytes per slave
Parameterization data per slave	7 bytes standard parameter per slave Max. 237 bytes application specific parameters per slave
Acyclic communication	DPV1 class 1 read, write DPV1 class 1 alarm DPV1 class 2 initiate, read, write, data transport, abort
Maximum number of acyclic read/write	240 bytes per slave and telegram
Functions	Configuration in Run (CiR), requires host application program support Timestamp (Master functionality)
Redundancy	Supported, requires host application program support
Baud rate	9,6 kBits/s, 19,2 kBits/s, 31,25 kBits/s, 45,45 kBits/s 93,75 kBits/s, 187,5 kBits/s, 500 kBits/s, 1, 5 MBits/s, 3 MBits/s, 6 MBits/s, 12 MBit/s Auto baud rate detection is not supported
Data transport layer	PROFIBUS FDL
Limitations	DPV2 isochronous mode and slave slave communication are not supported. The redundancy function can not be used, if the master is configured by the host application program by packets.
Reference to firmware/stack version	V2.8

Table 174: Technical Data PROFIBUS DP Master Protocol

9.4.14 PROFIBUS DP Slave

Parameter	Description
Maximum number of cyclic input data	244 bytes
Maximum number of cyclic output data	244 bytes
Maximum number of acyclic data (read/write)	240 bytes/telegram
Maximum number of modules	24
Configuration data	Max. 244 bytes
Parameter data	237 bytes application specific parameters
Acyclic communication	DP V1 Class 1 Read/Write DP V1 Class 1 Alarm DP V1 Class 2 Read/Write/Data Transport
Baud rate	9,6 kBits/s, 19,2 kBits/s, 31,25 kBits/s, 45,45 kBits/s, 93,75 kBits/s, 187,5 kBits/s, 500 kBits/s, 1, 5 MBits/s, 3 MBits/s, 6 MBits/s, 12 MBit/s Auto baudrate detection is supported
Data transport layer	PROFIBUS FDL
Limitations	SSCY1S – Slave to slave communication state machine not implemented Data exchange broadcast not implemented I&M LR services other than Call-REQ/RES are not supported yet
Reference to firmware/stack version	V2.10

Table 175: Technical Data PROFIBUS DP Slave Protocol

9.4.15 PROFIBUS MPI

Parameter	Description
Maximum number of MPI connections	126
Maximum number of write data	216 bytes
Maximum number of read data	222 bytes
Functions	MPI Read/Write DB (data block), M (marker), Q (output), C (Counter), T (Timer) MPI Read I (Input) Data type bit to access to DB (data block), M (marker), Q (output) and I (Input, read only) MPI Connect (automatically when first read/write function is used) MPI Disconnect, MPI Disconnect All MPI Get OP Status MPI transparent (expert use only)
Baud rate	Fixed values ranging from 9,6 kBits/s to 12 MBit/s Auto-detection mode is supported
Data transport layer	PROFIBUS FDL
Reference to firmware/stack version	2.4

Table 176: Technical Data PROFIBUS-MPI Protocol

9.4.16 CANopen Master

Parameter	Description
Maximum number of CANopen nodes	126
Maximum number of cyclic input data	3584 bytes
Maximum number of cyclic output data	3584 bytes
Maximum number of receive PDOs	512
Maximum number of transmit PDOs	512
Exchange of process data	Via PDO transfer: - synchronized, - remotely requested and - event driven (change of date)
Acyclic communication	SDO Upload/Download, max. 512 bytes per request
Functions	Emergency message (consumer and producer) Node guarding / life guarding, heartbeat PDO mapping NMT Master SYNC protocol (producer) Simple boot-up process, reading object 1000H for identification
Baud rates	10 kBits/s, 20 kBits/s, 50 kBits/s, 100 kBits/s, 125 kBits/s, 250 kBits/s, 500 kBits/s, 800 kBits/s, 1 MBits/s
CAN layer 2 access	Send/receive via API supported (11 bit/29 bit)
Data transport layer	CAN Frames
CAN Frame type for CANopen	11 Bit
Reference to version	V2.14

Table 177: Technical Data CANopen Master Protocol

9.4.17 CANopen Slave

Parameter	Description
Maximum number of cyclic input data	512 bytes
Maximum number of cyclic output data	512 bytes
Maximum number of receive PDOs	64
Maximum number of transmit PDOs	64
Exchange of process data	Via PDO transfer - synchronized, - remotely requested and - event driven (change of date, event timer) On request of the host application program by packet
Acyclic communication	SDO upload/download (server only) Emergency message (producer) Timestamp (producer/consumer)
Functions	Node guarding / life guarding Heartbeat: 1 producer, max. 64 consumer PDO mapping NMT Slave SYNC protocol (consumer) Error behaviour (configurable): - in state operational: change to state pre-operational - in any state: no state change - in state operational or pre-operational: change to state stopped
Baud rates	10 kBits/s, 20 kBits/s, 50 kBits/s, 100 kBits/s, 125 kBits/s, 250 kBits/s, 500 kBits/s, 800 kBits/s, 1 MBits/s Auto baudrate detection is supported
CAN layer 2 access	Send/receive via API supported (11 bit/29 bit)
Data transport layer	CAN Frames
CAN Frame type for CANopen	11 Bit
Reference to firmware/stack version	V3.7

Table 178: Technical Data CANopen Slave Protocol

9.4.18 DeviceNet Master

Parameter	Description
Maximum number of DeviceNet slaves	63
Maximum number of total cyclic input data	3584 bytes
Maximum number of total cyclic output data	3584 bytes
Maximum number of cyclic input data	255 bytes/connection
Maximum number of cyclic output data	255 bytes/connection
Maximum Configuration data	1000 bytes/slave
Acyclic communication	Explicit connection All service codes are supported
Connections	Bit Strobe Change of State Cyclic Poll Explicit Peer-to-Peer Messaging
Function	Quick Connect
Fragmentation	Explicit and I/O
UCMM	Supported
Objects	Identity Object (Class Code 0x01) Message Router Object (Class Code 0x02) DeviceNet Object (Class Code 0x03) Connection Object (Class Code 0x05) Acknowledge Handler Object (Class Code 0x06)
Baud rates	125 kBits/s, 250 kBit/s, 500 kBit/s Auto baudrate detection is not supported
Data transport layer	CAN frames
Reference to firmware/stack version	V2.4

Table 179: Technical Data DeviceNet Master Protocol

9.4.19 DeviceNet Slave

Parameter	Description
Maximum number of cyclic input data	255 bytes
Maximum number of cyclic output data	255 bytes
Acyclic communication	Get_Attribute_Single/All Max. 240 bytes per request Set_Attribute_Single/All Max. 240 bytes per request
Connections	Poll Change-of-state Cyclic Bit-strobe
Explicit messaging	Supported
Fragmentation	Explicit and I/O
UCMM	Not supported
Baud rates	125 kBits/s, 250 kBit/s, 500 kBit/s Auto baudrate detection is not supported
Data transport layer	CAN frames
Reference to firmware/stack version	V2.5

Table 180: Technical Data DeviceNet Slave Protocol

9.4.20 CC Link Slave

Parameter	Description
Firmware works according to CC-Link Version 2.0:	
Station Types	Remote Device Station (up to 4 occupied stations)
Maximum input data	368 bytes
Maximum output data	368 bytes
Input data remote device station	112 bytes (RY) and 256 bytes (RWw)
Output data remote device station	112 bytes (RX) and 256 bytes (RWr)
Extension cycles	1, 2, 4, 8
Baud rates	156 kBit/s, 625 kBit/s, 2500 kBit/s, 5 MBit/s, 10 MBit/s
Limitation	Intelligent Device Station not supported
Firmware works according to CC-Link Version 1.11:	
Station Types	Remote I/O station, Remote device station' (up to 4 occupied stations)
Maximum input data	48 bytes
Maximum output data	48 bytes
Input data remote I/O station	4 bytes (RY)
Output data remote I/O station	4 bytes (RX)
Input data remote device station	4 bytes (RY) and 8 bytes (RWw) per occupied station
Output data remote device station	4 bytes (RX) and 8 bytes (RWr) per occupied station
Baud rates	156 kBit/s, 625 kBit/s, 2500 kBit/s, 5 MBit/s, 10 MBit/s
Firmware	
Reference to firmware/stack version	V2.12

Table 181: Technical Data CC-Link-Slave-Protocol

10 Dimensions

10.1 Tolerances of the shown Card Dimensions

The manufacturing tolerance of the printed circuit boards of the PC card cifX is ± 0.1 mm per milled PCB edge. For all dimensions of the PCB indicated on the drawings (in the sections *Dimensioning PC Cards cifX Compact PCI* from page 247, *Dimensioning PC Cards cifX Mini PCI and Mini PCI Express* from page 251, *Dimensioning PC Cards cifX PCI-104* from page 252 and *Dimensioning detached Network Interfaces* from page 259) thus results for the length L and the width W, a tolerance of ± 0.1 mm (per milled edge) $\times 2 = \pm 0.2$ mm.

$$W = [\textit{width of the board in mm}] \pm 0.2 \text{ mm}$$

$$L = [\textit{length of the board in mm}] \pm 0.2 \text{ mm}$$

The depth T of the PCB depends on the highest part used or the circuit board plus the descenders. The thickness of the PCB is $= 1.6 \text{ mm} \pm 10\%$.



Note: The dimensions (L x W x H) specified in section *Technical Data PC Cards cifX* on page 162 (and also the identical values in the data sheet cifX and on the 'Hilscher Site') are rounded and unified for the respective types of card. The depth of the PC cards Compact PCI (CIFX 80) has been equated to the rounded width of the front panel.

10.2 Dimensioning PC Cards cifX Compact PCI

10.2.1 CIFX 80-RE

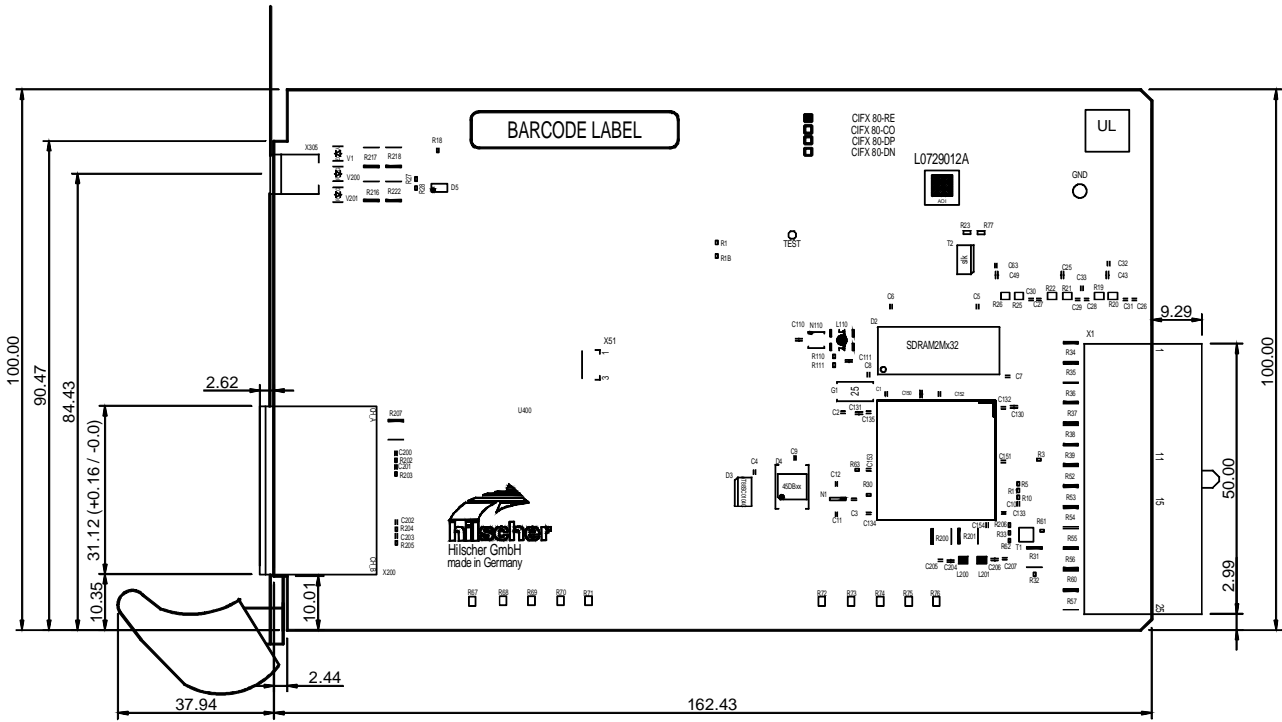

Figure 75: Dimensions CIFX 80E-RE

10.2.2 Front Panel CIFX 80-RE

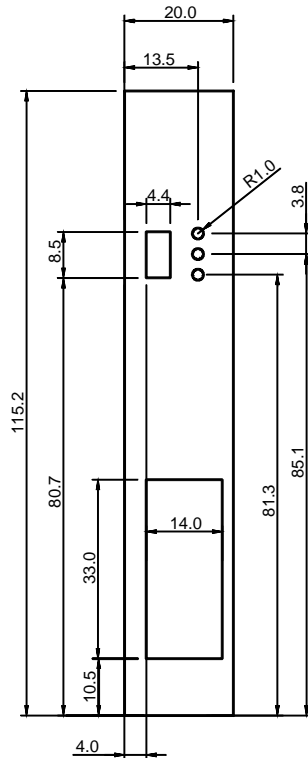

Figure 76: Dimensions Front Panel for CIFX 80-RE

10.2.3 CIFX 80-DP

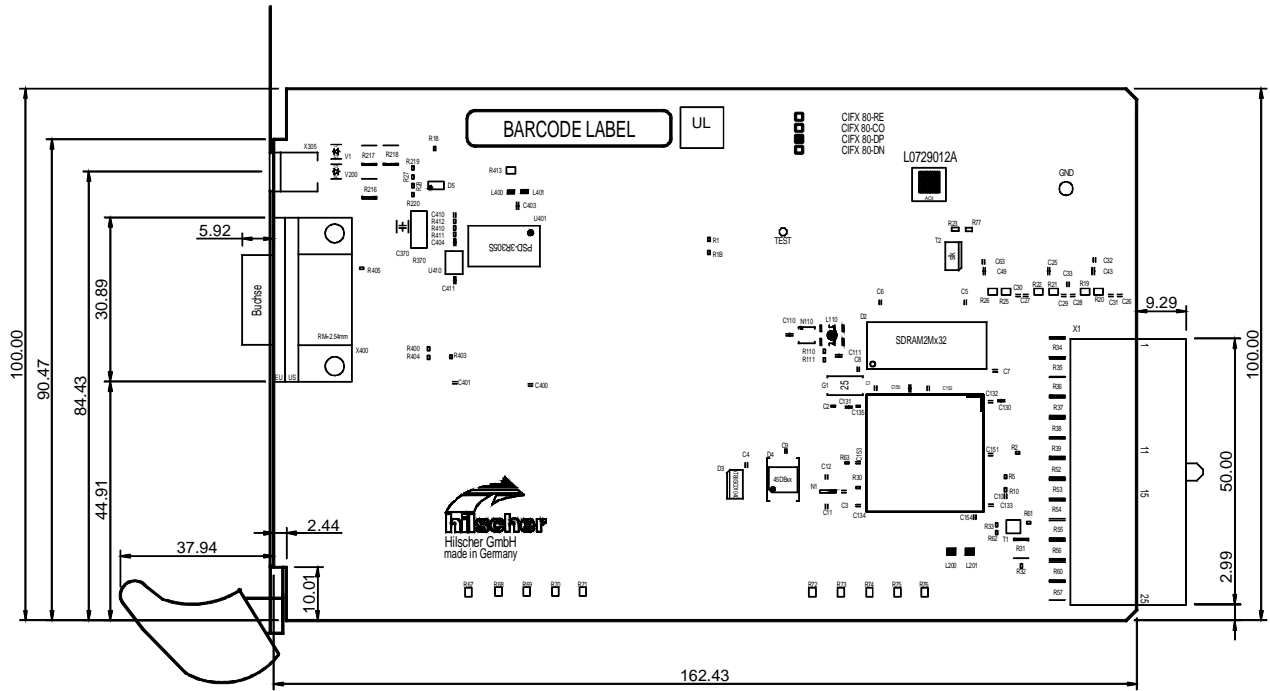

Figure 77: Dimensions CIFX 80-DP

10.2.4 Front Panel CIFX 80-DP

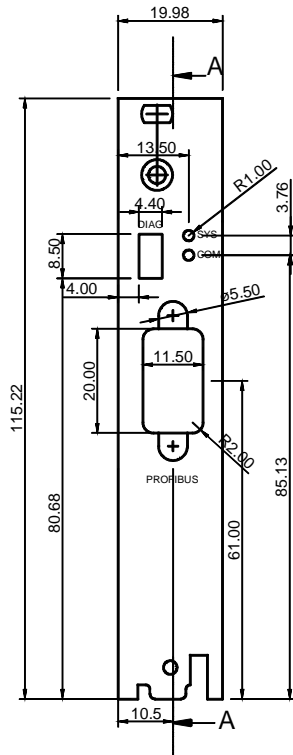

Figure 78: Front Panel for CIFX 80-DP

10.2.5 CIFX 80-CO

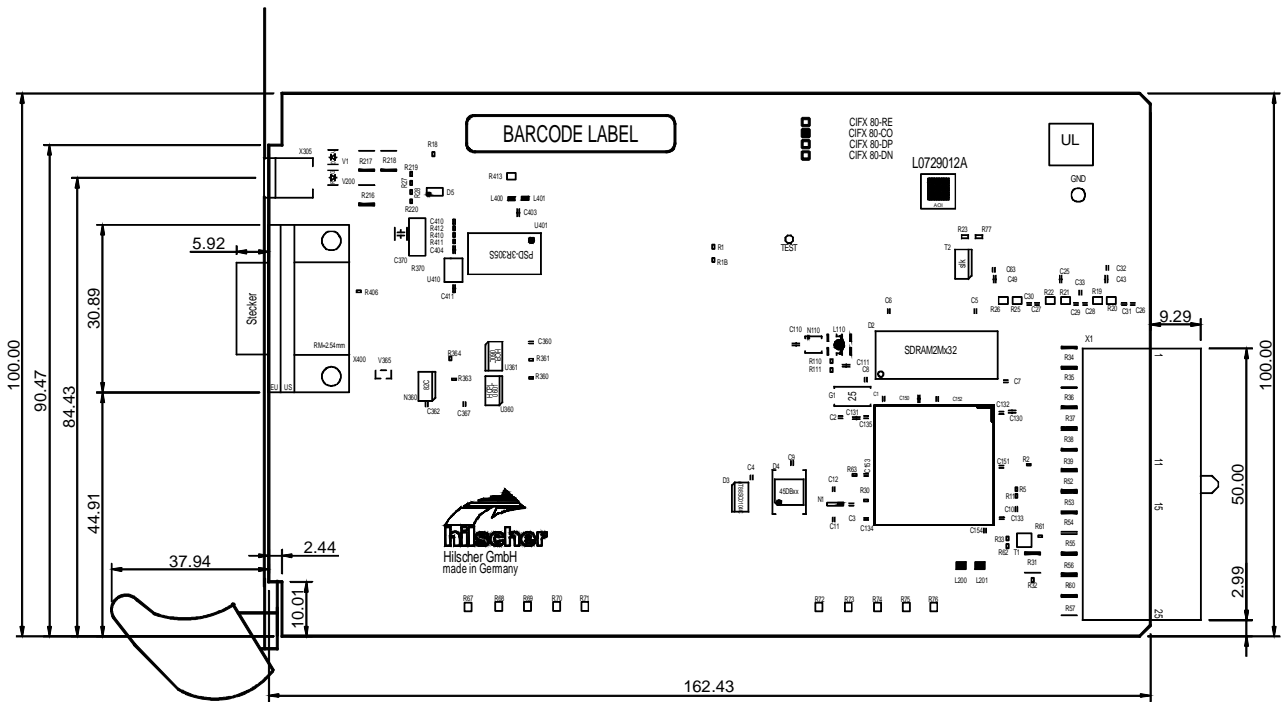

Figure 79: Dimensions CIFX 80-CO

10.2.6 Front Panel CIFX 80-CO

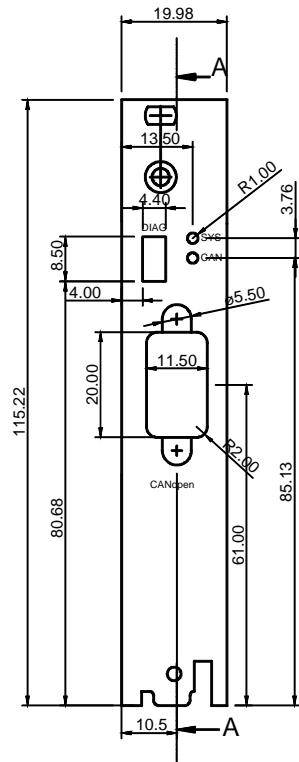

Figure 80: Dimensions Front Panel for CIFX 80-CO

10.2.7 CIFX 80-DN

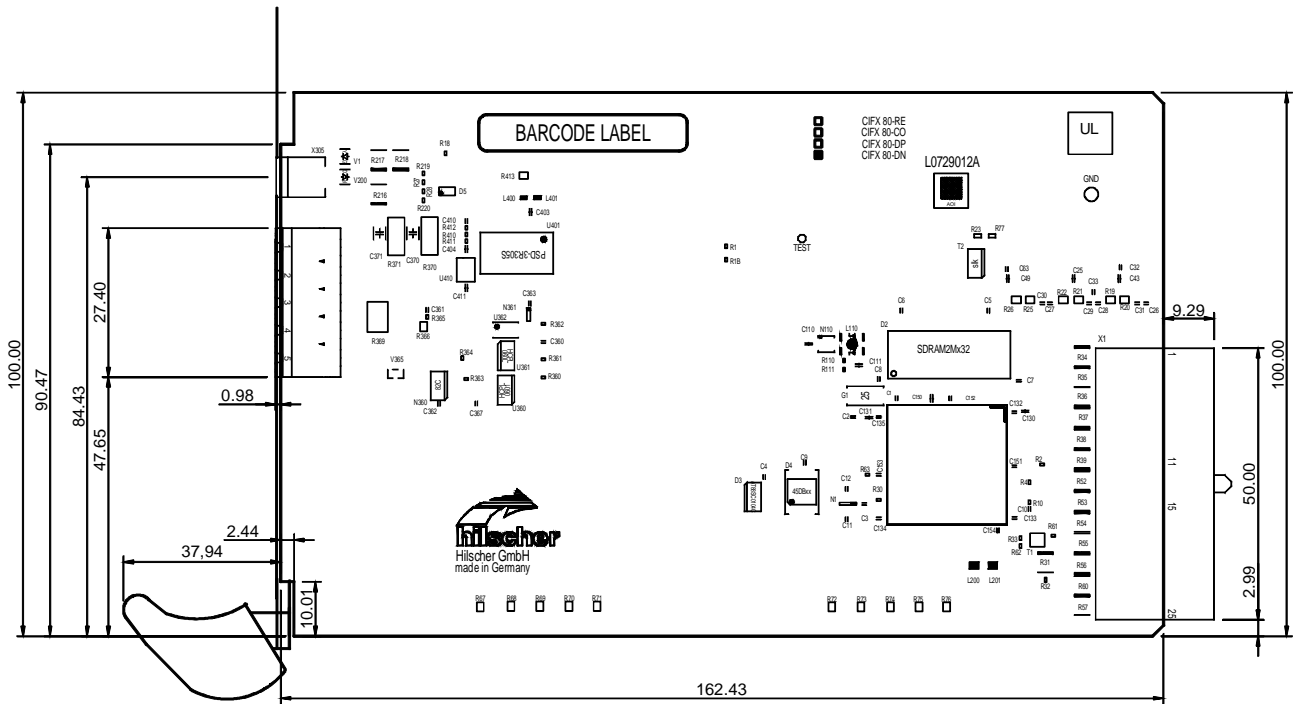

Figure 81: Dimensions CIFX 80-DN

10.2.8 Front Panel CIFX 80-DN

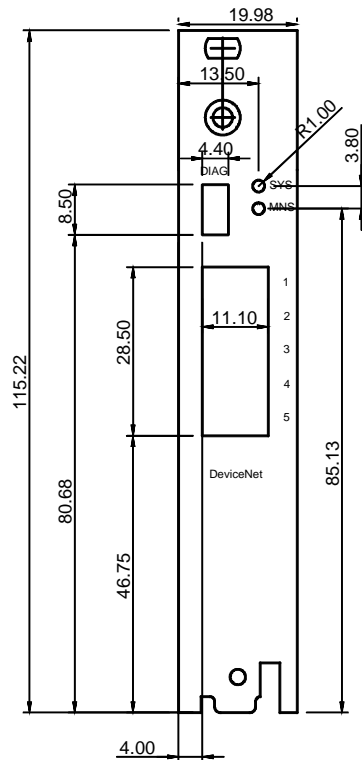

Figure 82: Dimensions Front Panel CIFX 80-DN

10.3 Dimensioning PC Cards cifX Mini PCI and Mini PCI Express

10.3.1 CIFX 90-XX\F and Variants

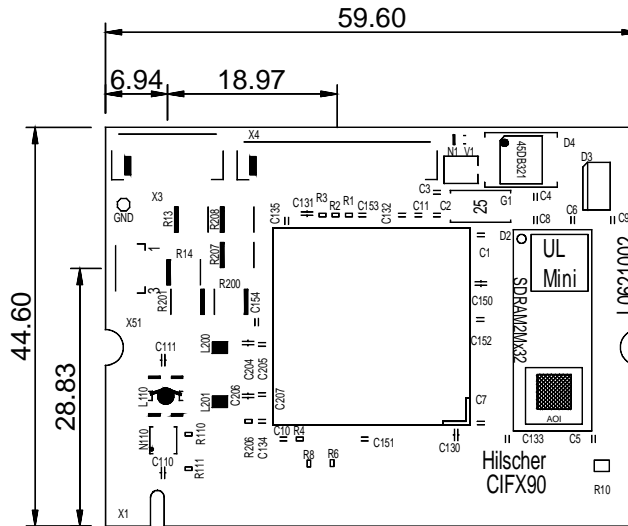

Figure 83: Dimensions CIFX 90-XX\F and Variants

10.3.2 CIFX 90E-XX\F and Variants

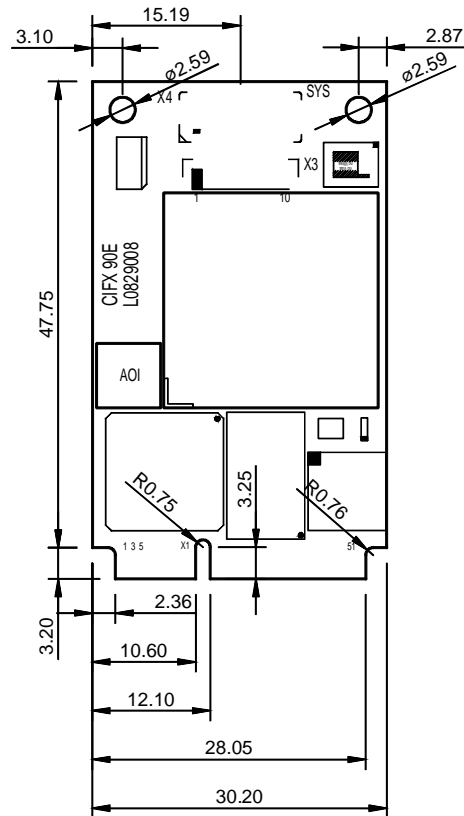

Figure 84: Dimensions CIFX 90E-XX\F and Variants



Note: The matrix label is positioned on the reverse side of the card, refer to section *Reverse Side CIFX 90-XX\F, CIFX 90E-XX\F and Variants* on page 40.

10.4 Dimensioning PC Cards cifX PCI-104

10.4.1 CIFX 104C-RE

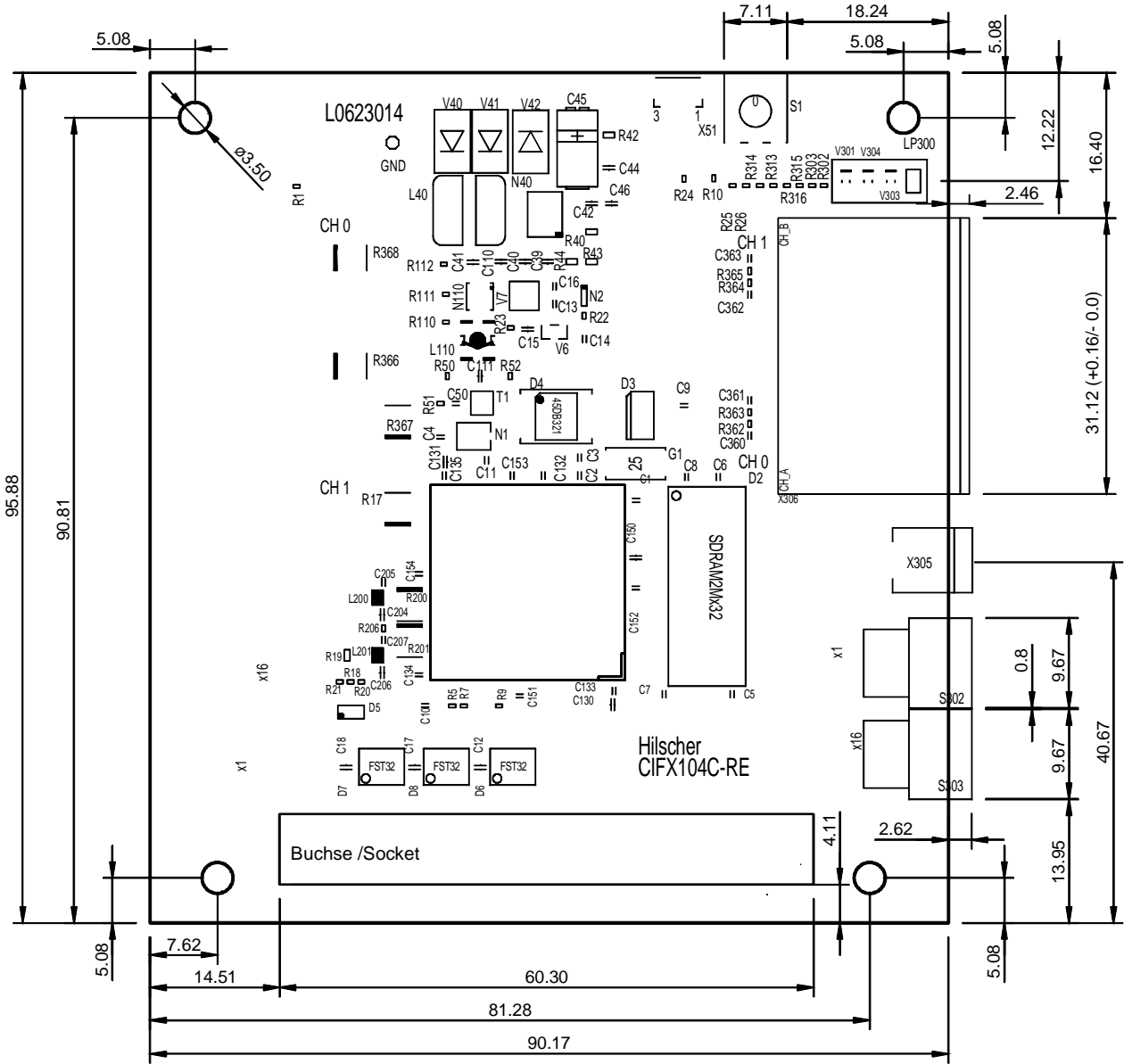

Figure 85: Dimensions CIFX 104C-RE

10.4.2 CIFX 104C-REVF

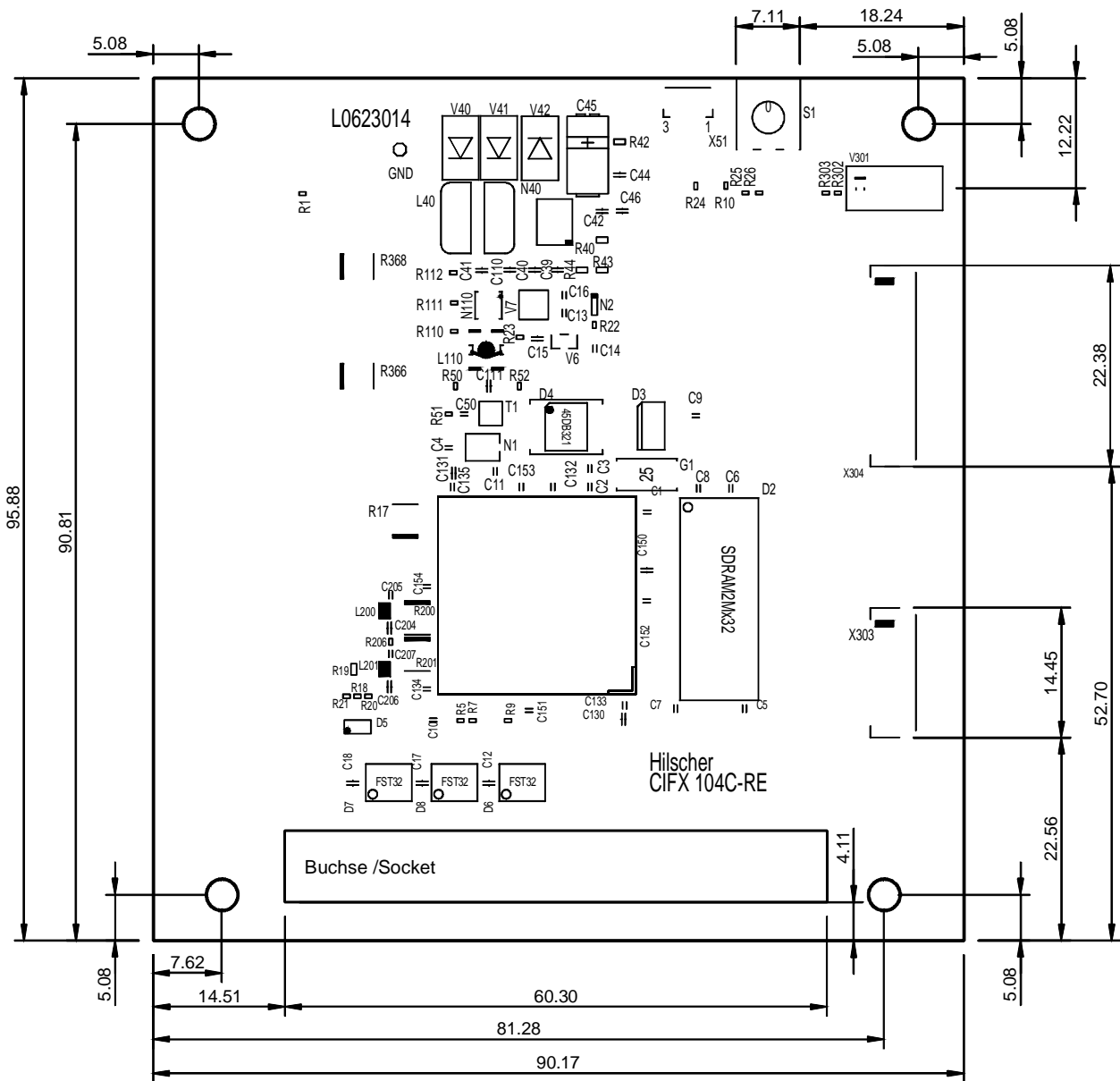

Figure 86: Dimensions CIFX 104C-REVF

10.4.3 CIFX 104C-DP

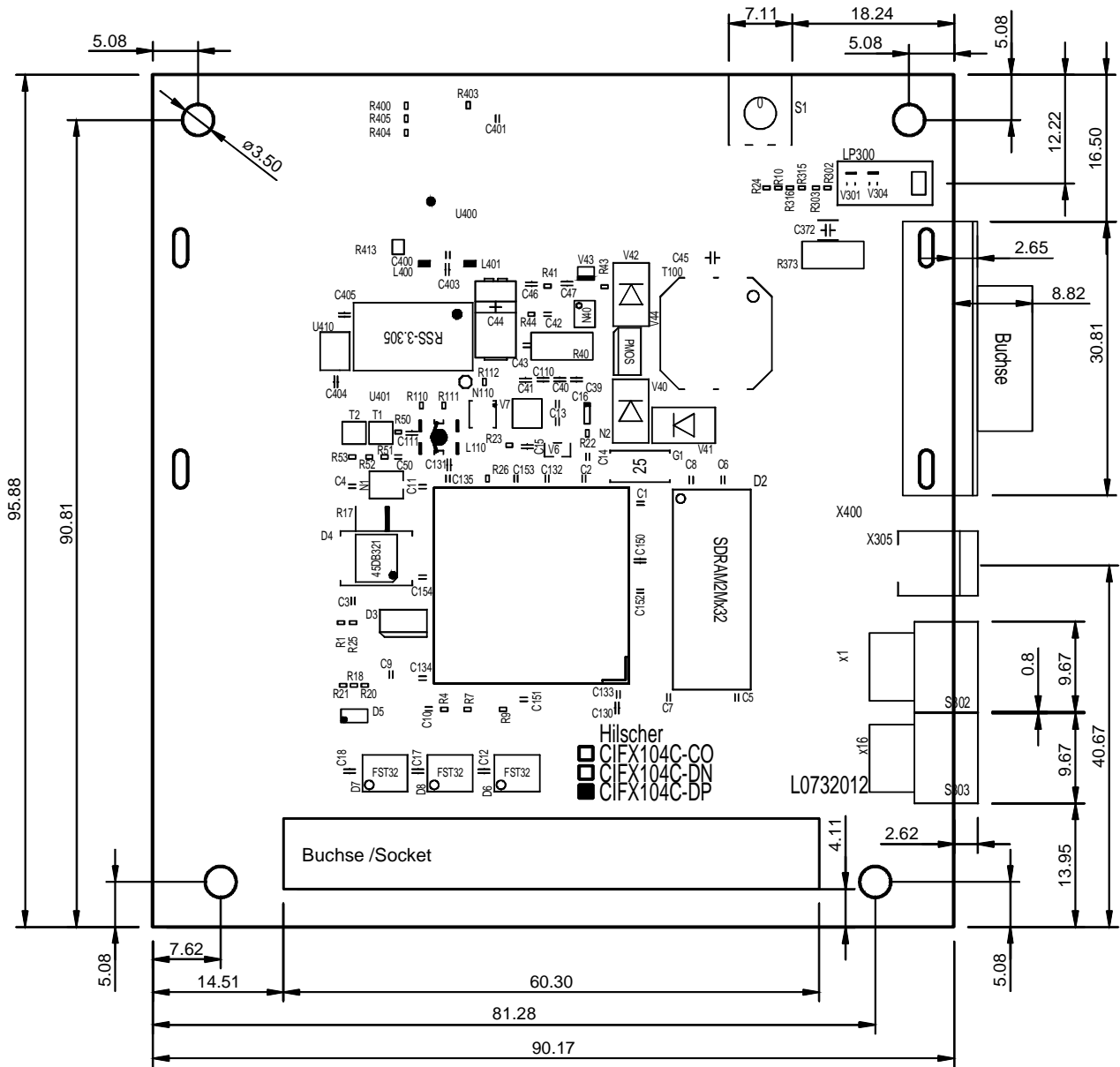

Figure 87: Dimensions CIFX 104C-DP

10.4.4 CIFX 104C-CO

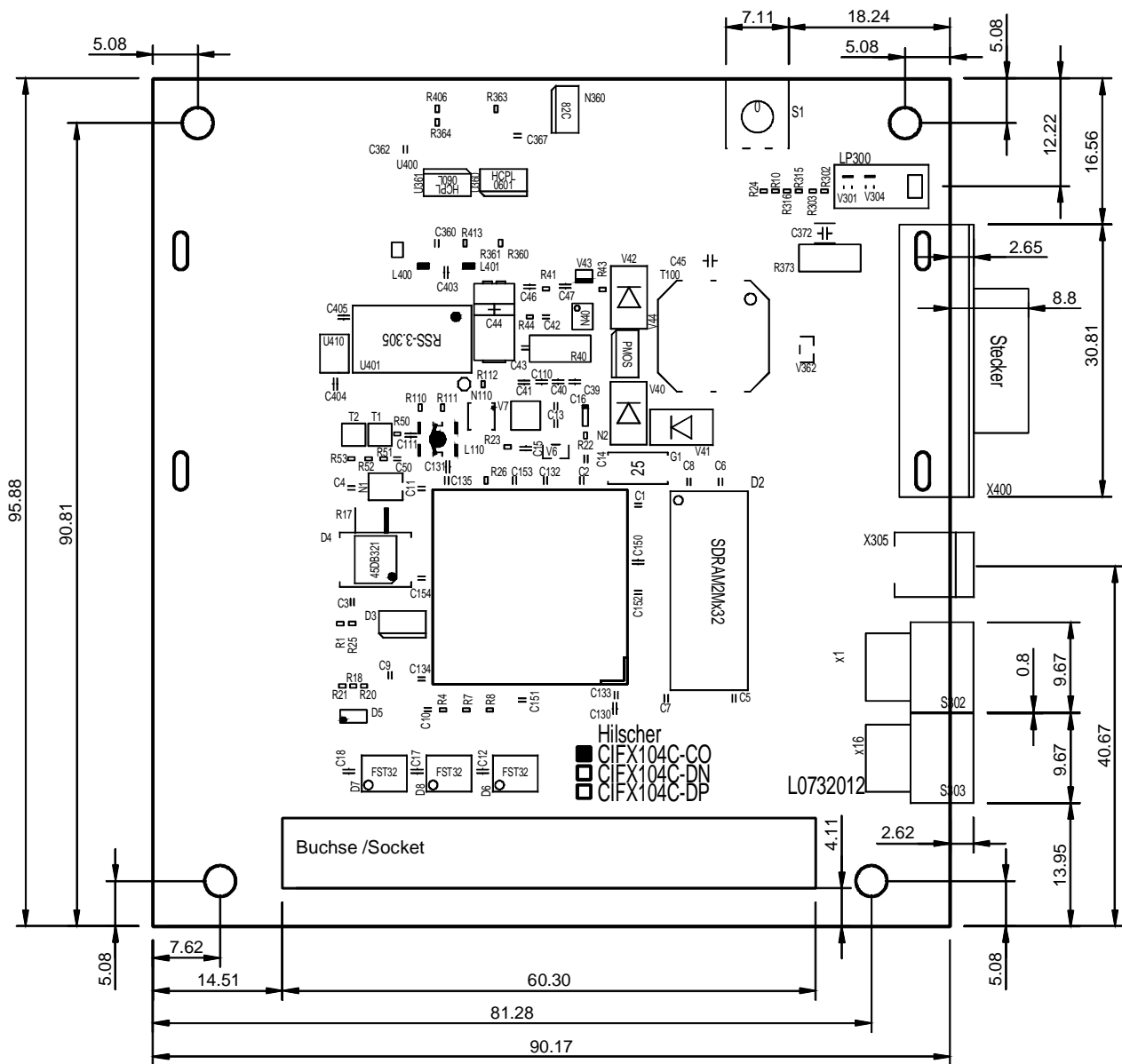

Figure 88: Dimensions CIFX 104C-CO

10.4.5 CIFX 104C-DN

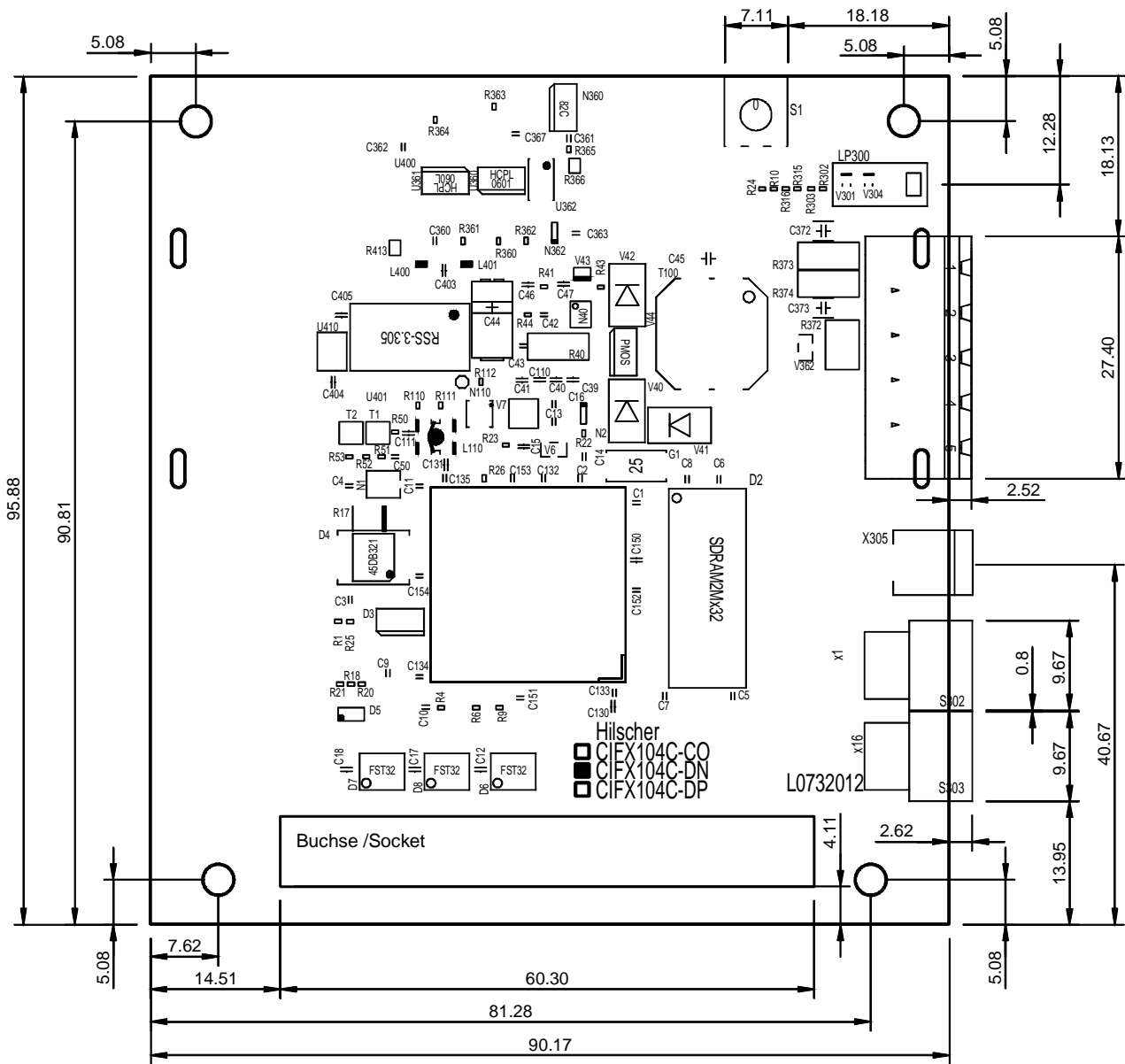

Figure 89: Dimensions CIFX 104C-DN

10.4.6 CIFS 104C-FBVF

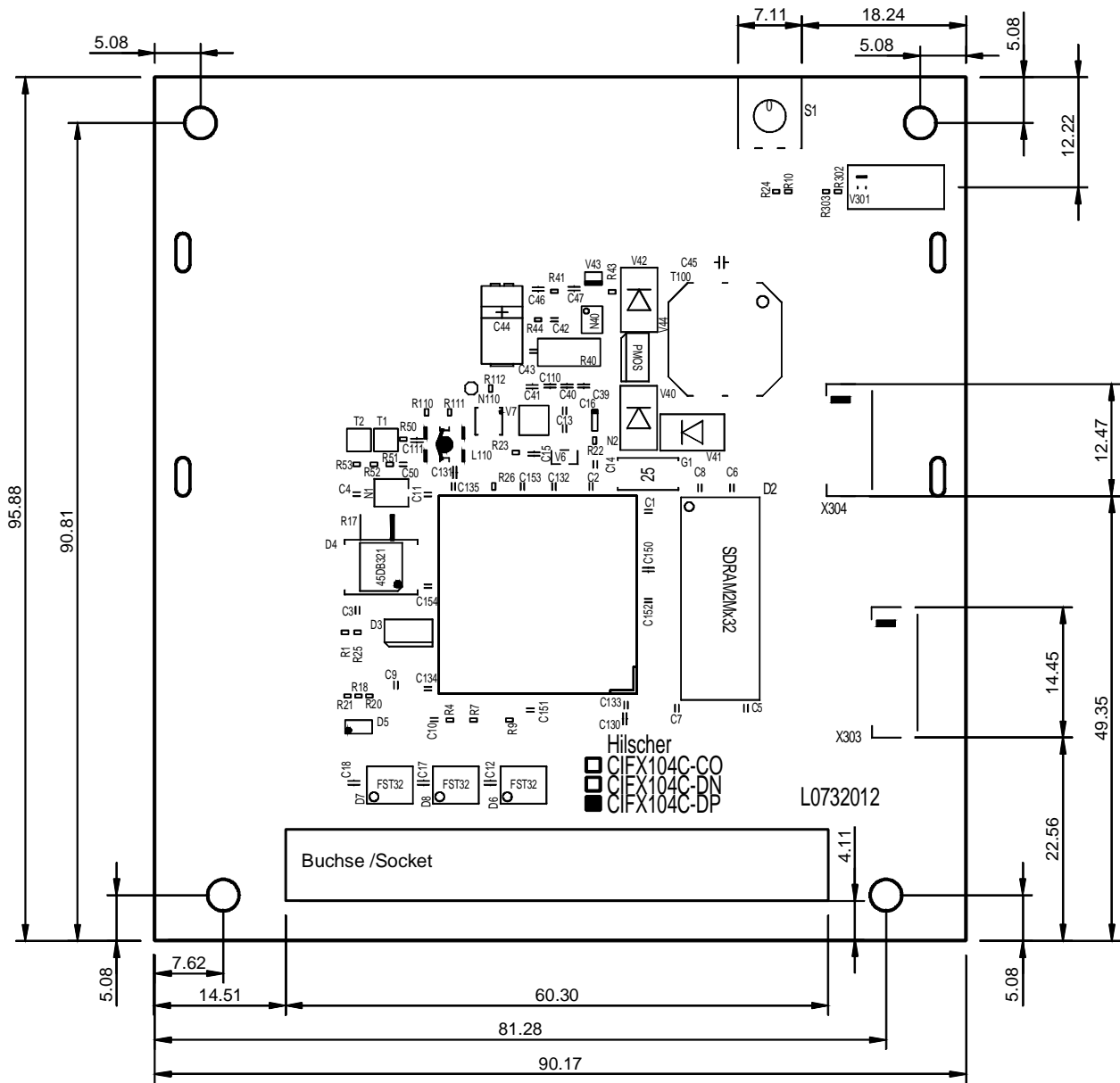

Figure 90: Dimensions CIFS 104C-FBVF

10.4.7 Reverse Side CIFX 104C-XX (all Basic Cards and Variants)

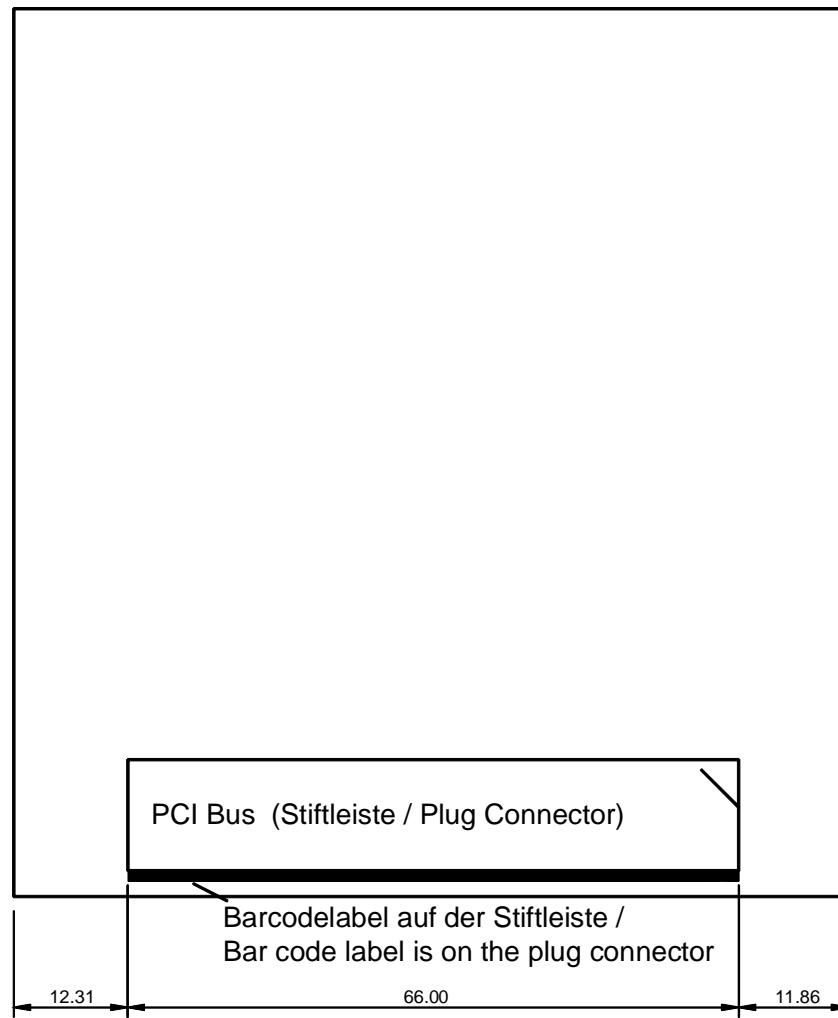

Figure 91: Reverse Side CIFX 104C-XX (all Basic Cards and Variants)

10.5 Dimensioning detached Network Interfaces AIFX

10.5.1 Ethernet - AIFX-RE

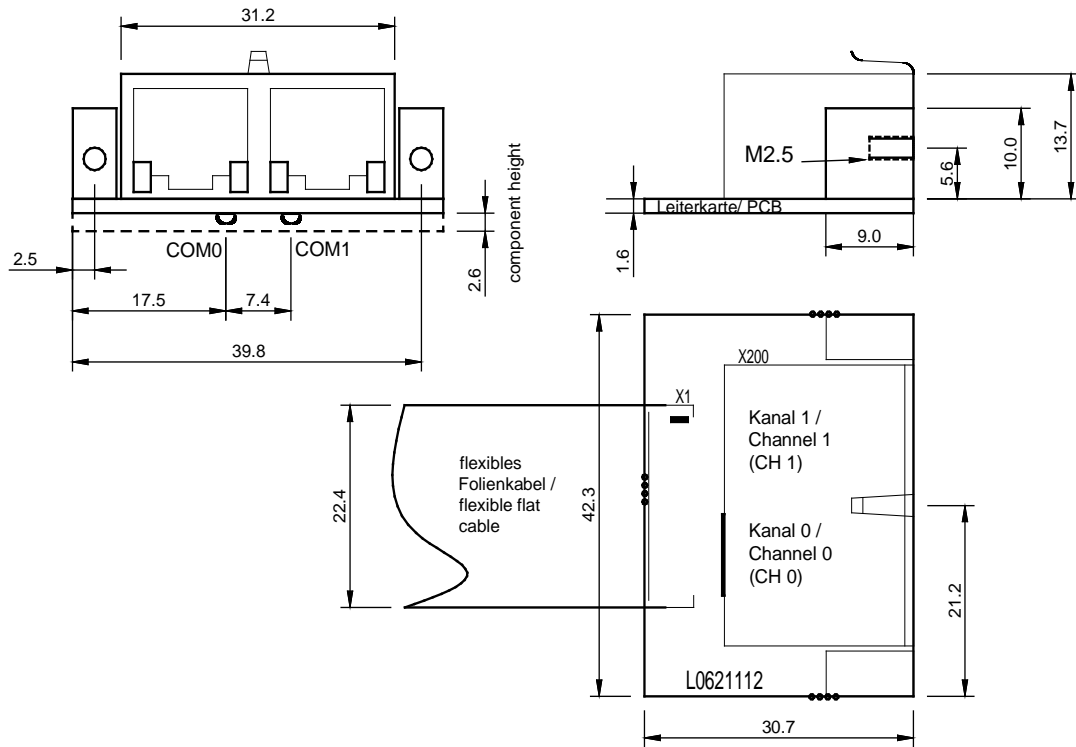

Figure 92: Dimensioning Ethernet detached Network Interface (AIFX-RE)

10.5.2 Ethernet M12 - AIFX-RE\M12

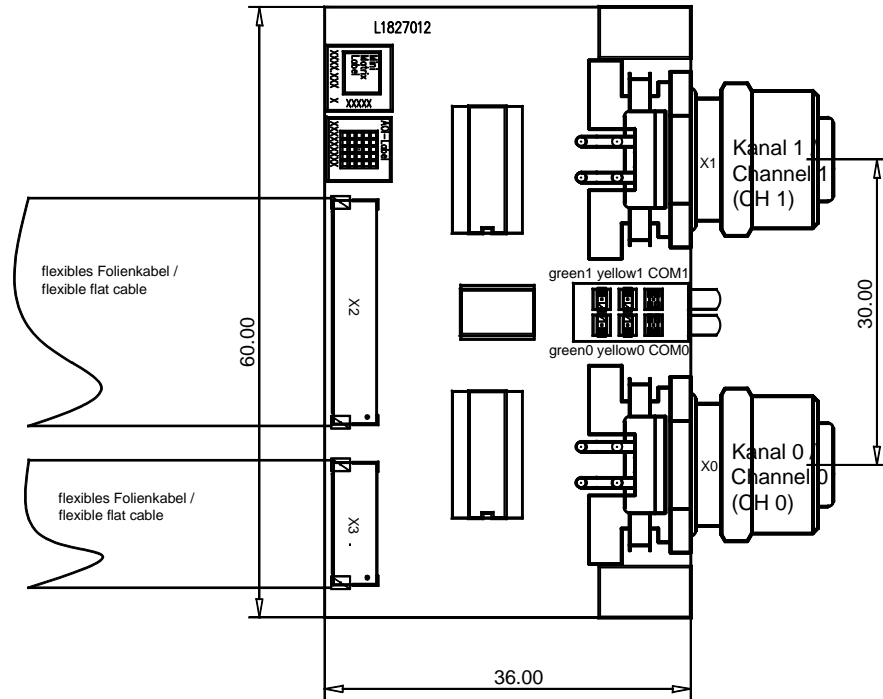

Figure 93: Dimensioning Detached Network Interface Ethernet (AIFX-REM12)

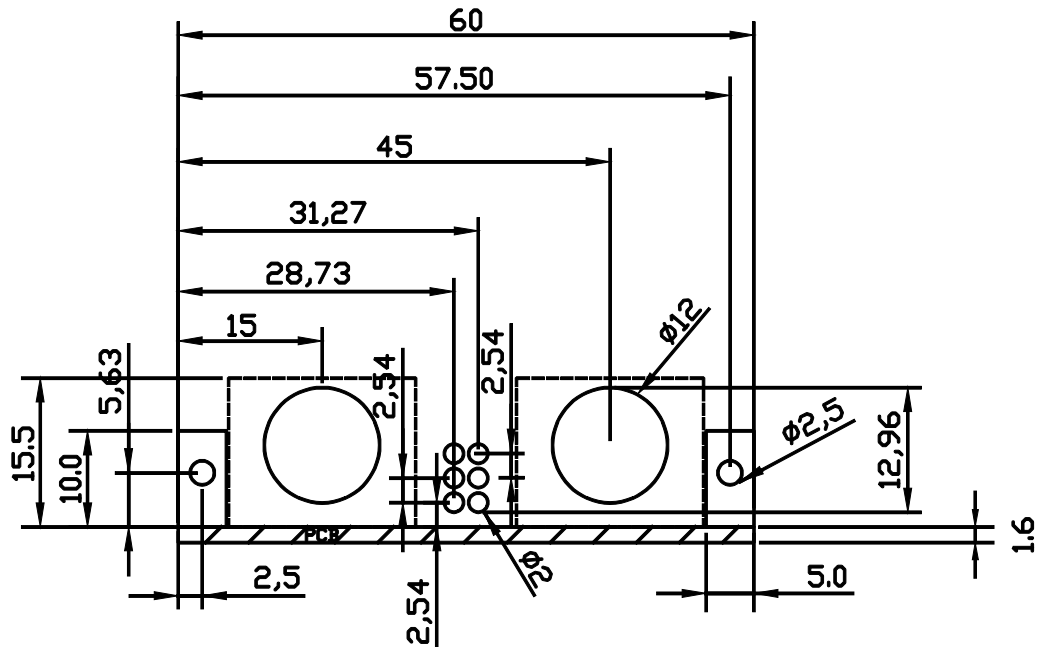

Figure 94: Drawing Panel Cutout Detached Network Interface Ethernet (AIFX-REM12)

Front panel thickness: 2-3 mm

10.5.3 PROFIBUS - AIFX-DP

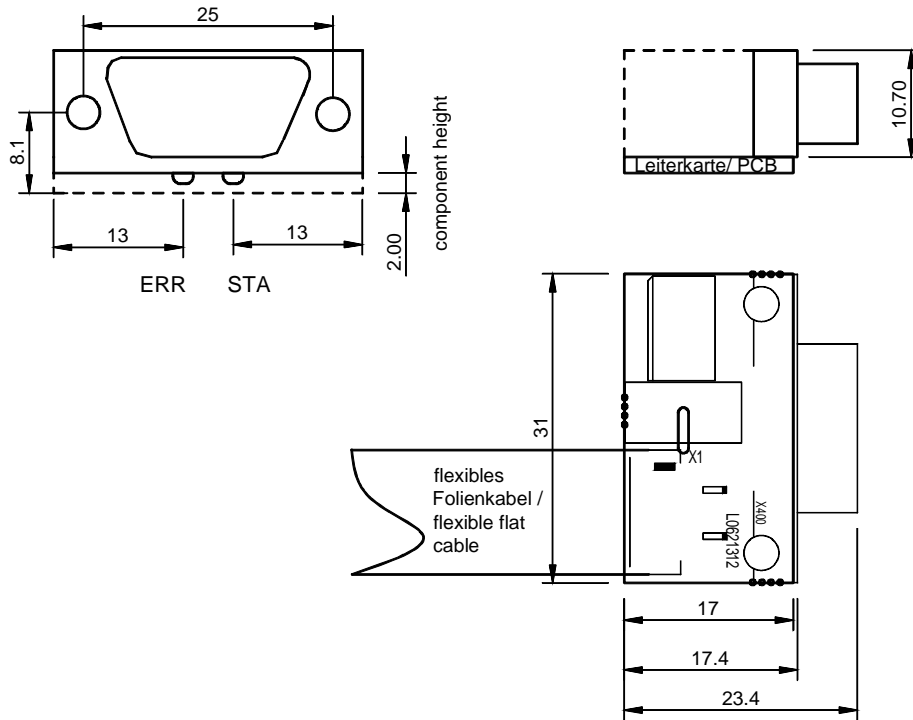

Figure 95: Dimensioning PROFIBUS detached Network Interface (AIFX-DP)

10.5.4 CANopen - AIFX-CO

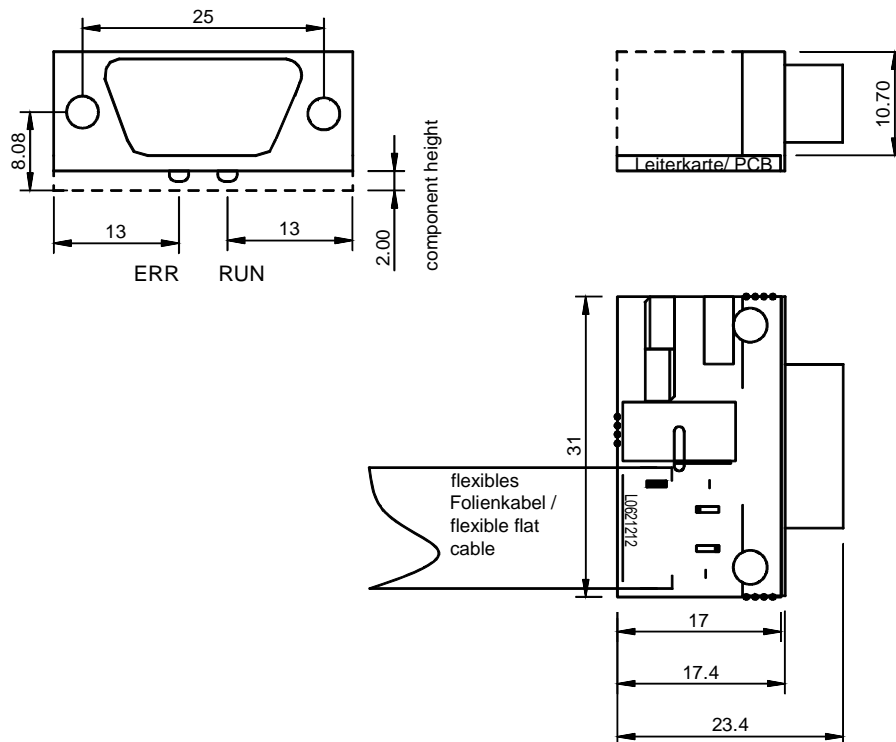

Figure 96: Dimensioning CANopen detached Network Interface (AIFX-CO)

10.5.5 DeviceNet - AIFX-DN

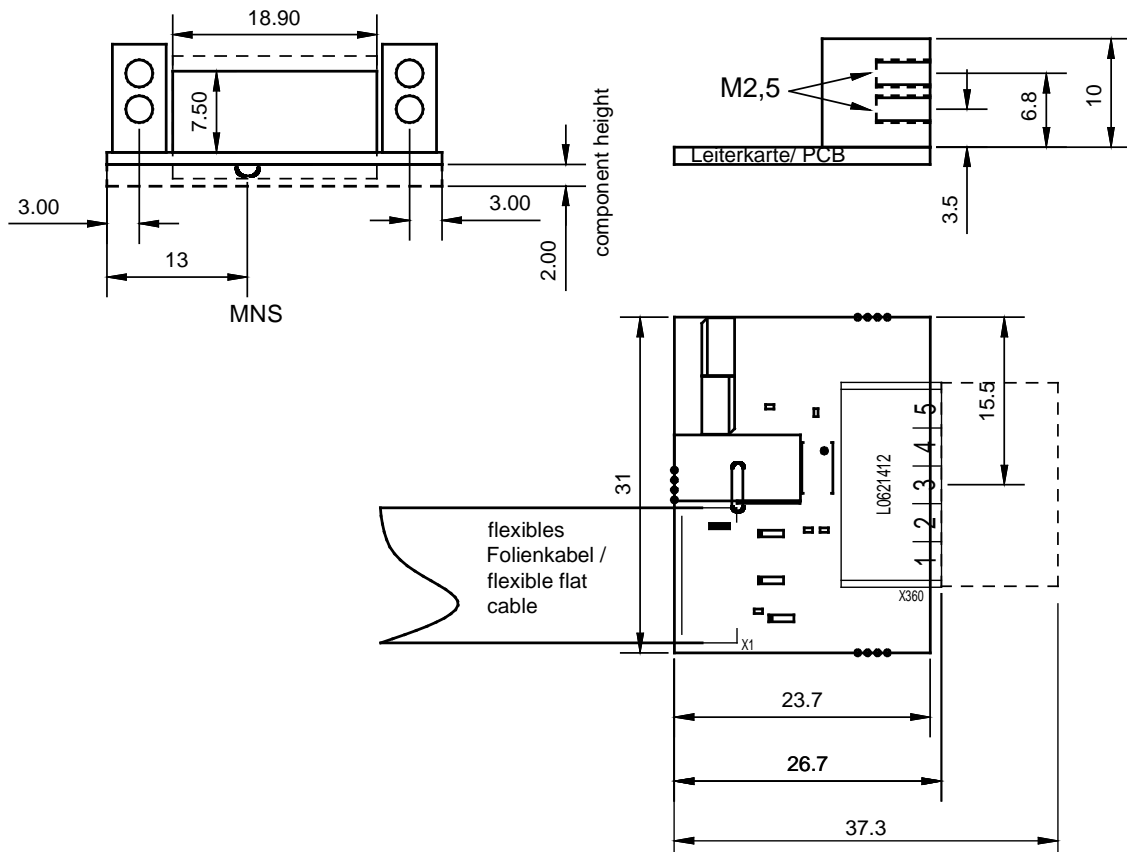

Figure 97: Dimensioning DeviceNet detached Network Interface (AIFX-DN, with counter part)

10.5.6 CC-Link - AIFX-CC

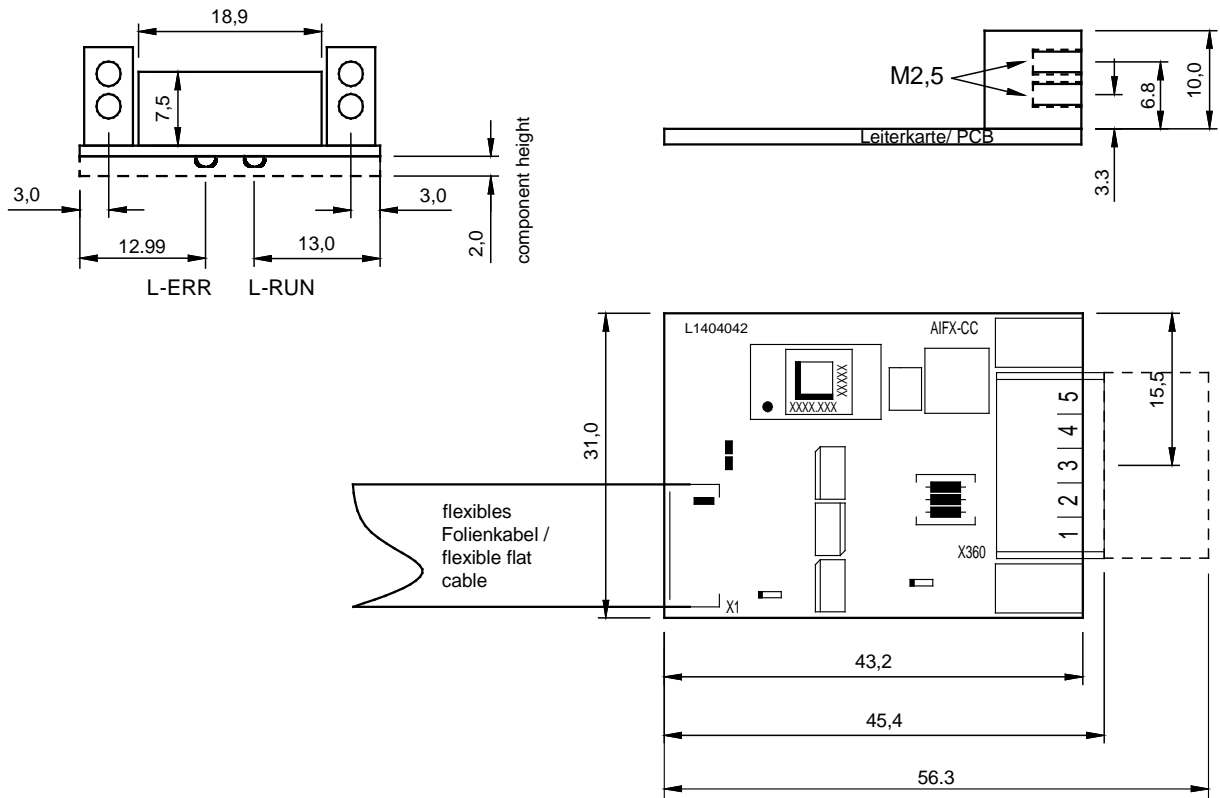

Figure 98: Dimensioning CC-Link detached Network Interface (AIFX-CC, with counter part)

10.5.7 Diagnose - AIFX-DIAG

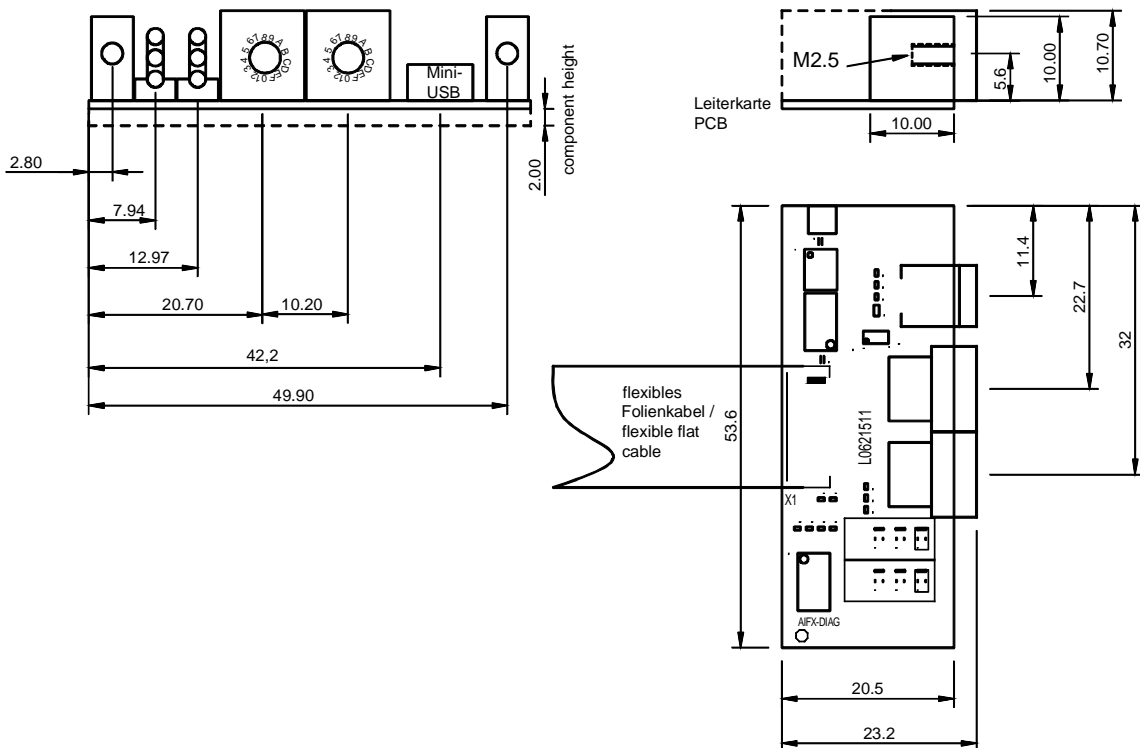

Figure 99: Dimensioning Diagnostic detached Network Interface (AIFX-DIAG)

11 Annex

11.1 References

- [1] THE CIP NETWORKS LIBRARY, Volume 6, CompoNet Adaptation of CIP, Edition 1.4 November 2008
- [2] Data sheet MOD JACK – MJIM:
<https://www.erni-x-press.com/de/downloads/zeichnungen/203313.pdf>
- [3] Design - Specification for VARAN Rev. 0.76, section 5.1.4 VARAN Splitter
- [4] Data sheet 99_3732_203_04.pdf (product data sheet of the manufacturer binder):
<https://catalog.weidmueller.com>

References Protocol API Manuals
• CANopen Master Protocol API Manual, Revision 16, Hilscher GmbH 2016
• CANopen Slave Protocol API Manual (V3), Revision 7, Hilscher GmbH 2016
• CC-Link IE Field-Basic Slave Protocol API, Revision 1, Hilscher GmbH 2018
• CC-Link Slave Protocol API Manual, Revision 12, Hilscher GmbH 2020
• DeviceNet Master Protocol API Manual, Revision 11, Hilscher GmbH 2016
• DeviceNet Slave Protocol API Manual, Revision 18, Hilscher GmbH 2020
• EtherCAT Master Protocol API Manual (V4), Revision 5, Hilscher GmbH 2017
• EtherCAT Slave Protocol API Manual (V4), Revision 12, Hilscher GmbH 2020
• EtherNet/IP Scanner Protocol API Manual, Revision 15, Hilscher GmbH 2020
• EtherNet/IP Adapter Protocol API Manual, Revision 20, Hilscher GmbH 2017
• Open Modbus/TCP Protocol API Manual, Revision 11, Hilscher GmbH 2018
• POWERLINK-Controlled-Node/Slave Protocol API Manual (V3), Revision 8, Hilscher GmbH 2018
• PROFIBUS DP-Master Protocol API Manual, Revision 22, Hilscher GmbH 2017
• PROFIBUS DP-Slave Protocol API Manual, Revision 20, Hilscher GmbH 2020
• PROFIBUS MPI Protocol API Manual, Revision 4, Hilscher GmbH 2011
• PROFINET IO-Controller Protocol API Manual (V3), Revision 8, Hilscher GmbH 2021
• PROFINET IO-Device Protocol API Manual (V4), Revision 4, Hilscher GmbH 2019
• Sercos Master Protocol API Manual, Revision 11, Hilscher GmbH 2013
• Sercos Slave Protocol API Manual (V3), Revision 17, Hilscher GmbH 2017
• VARAN Client Protocol API Manual, Revision 4, Hilscher GmbH 2021

Table 182: References Protocol API Manuals

11.1.1 References PCI Specifications

No.	Specification	Revision	Version	De	www
[bus spec 2]	PCI Express® Base Specification	2.0	-	January 15, 2007	pcisig.com
[bus spec 4]	CompactPCI™ Specification Short Form	2.1	2.0	September 2, 1997	picmg.org
[bus spec 5]	Mini PCI Specification	1.0	-	Oct, 25th 1999	pcisig.com
[bus spec 6]	PCI Express Mini Card Electromechanical Specification	1.1	-	March 28, 2005	
		1.2	-	October 26, 2007	
		2.0	-	April 21, 2012	
[bus spec 7]	PCI-104 Specification		1.0	November 2003	

Table 183: References PCI Specifications

11.1.2 References Safety

- [S1] American National Standards Institute, Inc.: American National Standard, Product Safety Information in Product Manuals, Instructions, and Other Collateral Materials, ANSI Z535.6-2016, English, 2016.
- [S2] DIN Deutsches Institut für Normung e. v. and VDE Verband der Elektrotechnik Elektronik Informationstechnik e. V.: German standard, Equipment for audio/video, information and communication technology - Part 1: Safety requirements, (IEC 62368-1:2014, modified + Cor.:2015); English version EN 62368-1:2014 + AC:2015, English, 2016-05.
- [S3] DIN Deutsches Institut für Normung e. v. and VDE Verband der Elektrotechnik Elektronik Informationstechnik e. V.: German standard, Electrostatics - Part 5-1: Protection of electronic components against electrostatic phenomena, General requirements, (IEC 61340-5-1:2016); English version EN 61340-5-1:2016, English, 2017-07.
- DIN Deutsches Institut für Normung e. v. und VDE Verband der Elektrotechnik Elektronik Informationstechnik e. V.: German standard, Electrostatics - Part 5-2: Protection of electronic components against electrostatic phenomena, User manual, (IEC TR 61340-5-2:2018), DIN IEC/TR 61340-5-2 (VDE V 0300-5-2), English, 2019-04.

11.1.3 Used Terminology

PC Card cifX	Communication Interfaces of the cifX family of Hilscher based on the netX technology.
CIFX 80-RE	Example for the product name for a PC card cifX Real-Time Ethernet.
CIFX 90E-XX	Example ('XX' replaces 'RE', 'DP', 'CO', 'DN' or 'CC')
CIFX 90E-FB	Example ('FB' replaces 'DP', 'CO', 'DN' or 'CC')



For further terminology to the PC cards cifX, its installation, configuration and operation refer to section *Glossary* on page 284.

11.2 Conventions in this Manual

Instructions and results

1. Operational purpose

2. Operational purpose

➤ Instruction

⇒ Result

Signs and Signal Words









Sign	Note
	General note
	Important note that must be followed to prevent malfunctions
	Reference on further information (acc. to ISO 7010 M001)
	Disconnect the power plug (acc. to ISO 7010 M006)
	Warning of Personal Injury and Property Damage Message (acc. to ISO 7010 W001) USA: Warning of Personal Injury As in the scope of the ANSI Z535 Standard (for USA) instructions to a property damage message may not contain a warning triangle, this property damage messages are listed separately for the USA.
	Warning of hazardous voltage! (acc. to ISO 7010 W012) Danger to life, risk of injury by electric shock
	USA: Warning of hazardous voltage! (acc. to ANSI Z535.4) Danger to life, risk of injury by electric shock
	Warning of damage due to electrostatic discharge (acc. to IEC 60417-5134)

Table 184: General Signs, Principles, Safety signs





Signal word	USA	Description
DANGER		Indicates a hazardous situation which if not avoided, will result in death or serious injury.
WARNING		Indicates a hazardous situation which if not avoided, could result in death or serious injury.
CAUTION		Indicates a hazardous situation which if not avoided, may result in minor or moderate injury.
NOTICE		Indicates a property damage message.

Table 185: Signal Words

11.3 Legal Notes

Copyright

© Hilscher Gesellschaft für Systemautomation mbH

All rights reserved.

The images, photographs and texts in the accompanying materials (in the form of a user's manual, operator's manual, Statement of Work document and all other document types, support texts, documentation, etc.) are protected by German and international copyright and by international trade and protective provisions. Without the prior written consent, you do not have permission to duplicate them either in full or in part using technical or mechanical methods (print, photocopy or any other method), to edit them using electronic systems or to transfer them. You are not permitted to make changes to copyright notices, markings, trademarks or ownership declarations. Illustrations are provided without taking the patent situation into account. Any company names and product designations provided in this document may be brands or trademarks by the corresponding owner and may be protected under trademark, brand or patent law. Any form of further use shall require the express consent from the relevant owner of the rights.

Important notes

Utmost care was/is given in the preparation of the documentation at hand consisting of a user's manual, operating manual and any other document type and accompanying texts. However, errors cannot be ruled out. Therefore, we cannot assume any guarantee or legal responsibility for erroneous information or liability of any kind. You are hereby made aware that descriptions found in the user's manual, the accompanying texts and the documentation neither represent a guarantee nor any indication on proper use as stipulated in the agreement or a promised attribute. It cannot be ruled out that the user's manual, the accompanying texts and the documentation do not completely match the described attributes, standards or any other data for the delivered product. A warranty or guarantee with respect to the correctness or accuracy of the information is not assumed.

We reserve the right to modify our products and the specifications for such as well as the corresponding documentation in the form of a user's manual, operating manual and/or any other document types and accompanying texts at any time and without notice without being required to notify of said modification. Changes shall be taken into account in future manuals and do not represent an obligation of any kind, in particular there shall be no right to have delivered documents revised. The manual delivered with the product shall apply.

Under no circumstances shall Hilscher Gesellschaft für Systemautomation mbH be liable for direct, indirect, ancillary or subsequent damage, or for any loss of income, which may arise after use of the information contained herein.

Liability disclaimer

The hardware and/or software was created and tested by Hilscher Gesellschaft für Systemautomation mbH with utmost care and is made available as is. No warranty can be assumed for the performance or

flawlessness of the hardware and/or software under all application conditions and scenarios and the work results achieved by the user when using the hardware and/or software. Liability for any damage that may have occurred as a result of using the hardware and/or software or the corresponding documents shall be limited to an event involving willful intent or a grossly negligent violation of a fundamental contractual obligation. However, the right to assert damages due to a violation of a fundamental contractual obligation shall be limited to contract-typical foreseeable damage.

It is hereby expressly agreed upon in particular that any use or utilization of the hardware and/or software in connection with

- Flight control systems in aviation and aerospace;
- Nuclear fusion processes in nuclear power plants;
- Medical devices used for life support and
- Vehicle control systems used in passenger transport

shall be excluded. Use of the hardware and/or software in any of the following areas is strictly prohibited:

- For military purposes or in weaponry;
- For designing, engineering, maintaining or operating nuclear systems;
- In flight safety systems, aviation and flight telecommunications systems;
- In life-support systems;
- In systems in which any malfunction in the hardware and/or software may result in physical injuries or fatalities.

You are hereby made aware that the hardware and/or software was not created for use in hazardous environments, which require fail-safe control mechanisms. Use of the hardware and/or software in this kind of environment shall be at your own risk; any liability for damage or loss due to impermissible use shall be excluded.

Warranty

Hilscher Gesellschaft für Systemautomation mbH hereby guarantees that the software shall run without errors in accordance with the requirements listed in the specifications and that there were no defects on the date of acceptance. The warranty period shall be 12 months commencing as of the date of acceptance or purchase (with express declaration or implied, by customer's conclusive behavior, e.g. putting into operation permanently).

The warranty obligation for equipment (hardware) we produce is 36 months, calculated as of the date of delivery ex works. The aforementioned provisions shall not apply if longer warranty periods are mandatory by law pursuant to Section 438 (1.2) BGB, Section 479 (1) BGB and Section 634a (1) BGB [Bürgerliches Gesetzbuch; German Civil Code] If, despite of all due care taken, the delivered product should have a defect, which already existed at the time of the transfer of risk, it shall be at our discretion to either repair the product or to deliver a replacement product, subject to timely notification of defect.

The warranty obligation shall not apply if the notification of defect is not asserted promptly, if the purchaser or third party has tampered with the products, if the defect is the result of natural wear, was caused by unfavorable operating conditions or is due to violations against our

operating regulations or against rules of good electrical engineering practice, or if our request to return the defective object is not promptly complied with.

Costs of support, maintenance, customization and product care

Please be advised that any subsequent improvement shall only be free of charge if a defect is found. Any form of technical support, maintenance and customization is not a warranty service, but instead shall be charged extra.

Additional guarantees

Although the hardware and software was developed and tested in-depth with greatest care, Hilscher Gesellschaft für Systemautomation mbH shall not assume any guarantee for the suitability thereof for any purpose that was not confirmed in writing. No guarantee can be granted whereby the hardware and software satisfies your requirements, or the use of the hardware and/or software is uninterrupted or the hardware and/or software is fault-free.

It cannot be guaranteed that patents and/or ownership privileges have not been infringed upon or violated or that the products are free from third-party influence. No additional guarantees or promises shall be made as to whether the product is market current, free from deficiency in title, or can be integrated or is usable for specific purposes, unless such guarantees or promises are required under existing law and cannot be restricted.

Confidentiality

The customer hereby expressly acknowledges that this document contains trade secrets, information protected by copyright and other patent and ownership privileges as well as any related rights of Hilscher Gesellschaft für Systemautomation mbH. The customer agrees to treat as confidential all of the information made available to customer by Hilscher Gesellschaft für Systemautomation mbH and rights, which were disclosed by Hilscher Gesellschaft für Systemautomation mbH and that were made accessible as well as the terms and conditions of this agreement itself.

The parties hereby agree to one another that the information that each party receives from the other party respectively is and shall remain the intellectual property of said other party, unless provided for otherwise in a contractual agreement.

The customer must not allow any third party to become knowledgeable of this expertise and shall only provide knowledge thereof to authorized users as appropriate and necessary. Companies associated with the customer shall not be deemed third parties. The customer must obligate authorized users to confidentiality. The customer should only use the confidential information in connection with the performances specified in this agreement.

The customer must not use this confidential information to his own advantage or for his own purposes or rather to the advantage or for the purpose of a third party, nor must it be used for commercial purposes and this confidential information must only be used to the extent provided for in this agreement or otherwise to the extent as expressly authorized by the disclosing party in written form. The customer has the right, subject to the obligation to confidentiality, to disclose the terms and conditions of this agreement directly to his legal and financial consultants as would be required for the customer's normal business operation.

Export provisions

The delivered product (including technical data) is subject to the legal export and/or import laws as well as any associated regulations of various countries, especially such laws applicable in Germany and in the United States. The products / hardware / software must not be exported into such countries for which export is prohibited under US American export control laws and its supplementary provisions. You hereby agree to strictly follow the regulations and to yourself be responsible for observing them. You are hereby made aware that you may be required to obtain governmental approval to export, reexport or import the product.

11.4 Licenses

If a PC card cifX is used as a Slave, neither for the firmware nor for the configuration software SYCON.net a license is required.

Licenses will be required if the PC card cifX is used with

- a firmware with master functionality*.

* The master license includes the PC card cifX operating as master and the license for the configuration software SYCON.net for the respective cifX.

11.4.1 License Note about VARAN Client

In order to use the PC card cifX with VARAN, you need a license which you can acquire at the VNO (VARAN Bus-Nutzerorganisation, Bürmooser Straße 10, A-5112 Lamprechtshausen, info@varan-bus.net) after getting a member of VON.

The license as well as the Vendor ID and the Device ID can be adjusted with the SYCON.net configuration software or with the netX Configuration Tool.

11.5 Registered Trademarks

Windows[®] 7, Windows[®] 8, Windows[®] 8.1 and Windows[®] 10 are registered trademarks of Microsoft Corporation.

Linux is a registered trademark of Linus Torvalds.

QNX is a registered trademark of QNX Software Systems, Ltd.

VxWorks is a registered trademark of Wind River Systems, Inc.

IntervalZero RTX[™] is a trademark of IntervalZero.

Adobe-Acrobat[®] is a registered trademark of the Adobe Systems Incorporated.

CANopen[®] is a registered trademark of CAN in AUTOMATION - International Users and Manufacturers Group e.V (CiA), Nürnberg.

CC-Link and CC-Link IE Field are registered trademarks of Mitsubishi Electric Corporation, Tokyo, Japan.

DeviceNet[™] and EtherNet/IP[™] are trademarks of ODVA (Open DeviceNet Vendor Association, Inc).

EtherCAT[®] is a registered trademark and a patented technology of Beckhoff Automation GmbH, Verl, Germany, formerly Elektro Beckhoff GmbH.

Modbus is a registered trademark of Schneider Electric.

POWERLINK is a registered trademark of B&R, Bernecker + Rainer Industrie-Elektronik Ges.m.b.H, Eggelsberg, Austria

PROFIBUS[®] and PROFINET[®] are registered trademarks of PROFIBUS & PROFINET International (PI), Karlsruhe.

Sercos and Sercos interface are registered trademarks of Sercos international e. V., Suessen, Germany.

PCI[™], PCI EXPRESS[®] and PCIe[®] or MINI PCI[™] are trademarks or registered trademarks of the Peripheral Component Interconnect Special Interest Group (PCI-SIG).

CompactPCI[™] is a trademark of the PCI Industrial Manufacturers Group (PICMG).

All other mentioned trademarks are property of their respective legal owners.

11.6 EtherCAT Disclaimer

EtherCAT[®] is registered trademark and patented technology, licensed by Beckhoff Automation GmbH, Germany.



To get details and restrictions regarding using the EtherCAT technology refer to the following documents:

- “EtherCAT Marking rules”
- “EtherCAT Conformance Test Policy”
- “EtherCAT Vendor ID Policy”

These documents are available at the ETG homepage www.ethercat.org or directly over info@ethercat.org.

A summary over Vendor ID, Conformance test, Membership and Network Logo can be found hereafter.

11.6.1 EtherCAT Summary over Vendor ID, Conformance test, Membership and Network Logo

11.6.1.1 Vendor ID

The communication interface product is shipped with Hilscher's secondary vendor ID, which has to be replaced by the Vendor ID of the company shipping end products with the integrated communication interface. End Users or Integrators may use the communication interface product without further modification if they re-distribute the interface product (e.g. PCI Interface card products) only as part of a machine or machine line or as spare part for such a machine. In case of questions, contact Hilscher and/or your nearest ETG representative. The ETG Vendor-ID policies apply.

11.6.1.2 Conformance

EtherCAT Devices have to conform to the EtherCAT specifications. The EtherCAT Conformance Test Policies apply, which can be obtained from the EtherCAT Technology Group (ETG, www.ethercat.org).

Hilscher range of embedded network interface products are conformance tested for network compliance. This simplifies conformance testing of the end product and can be used as a reference for the end product as a statement of network conformance (when used with standard operational settings). It must however be clearly stated in the product documentation that this applies to the network interface and not to the complete product.

Conformance Certificates can be obtained by passing the conformance test in an official EtherCAT Conformance Test lab. Conformance Certificates are not mandatory, but may be required by the end user.

11.6.1.3 Certified Product vs. Certified Network Interface

The EtherCAT implementation may in certain cases allow one to modify the behavior of the EtherCAT network interface device in ways which are not in line with EtherCAT conformance requirements. For example, certain communication parameters are set by a software stack, in which case the actual software implementation in the device application determines whether or not the network interface can pass the EtherCAT conformance test. In such cases, conformance test of the end product must be passed to ensure that the implementation does not affect network compliance.

Generally, implementations of this kind require in-depth knowledge in the operating fundamentals of EtherCAT. To find out whether or not a certain type of implementation can pass conformance testing and requires such testing, contact EtherCAT Technology Group ("ETG", www.ethercat.org) and/or your nearest EtherCAT conformance test centre. EtherCAT may allow the combination of an untested end product with a conformant network interface. Although this may in some cases make it possible to sell the end product without having to perform network conformance tests, this approach is generally not endorsed by Hilscher. In case of questions, contact Hilscher and/or your nearest ETG representative.

11.6.1.4 Membership and Network Logo

Generally, membership in the network organization and a valid Vendor-ID are prerequisites in order to be able to test the end product for conformance. This also applies to the use of the EtherCAT name and logo, which is covered by the ETG marking rules.

Vendor ID Policy accepted by ETG Board of Directors, November 5, 2008

11.7 Notes on earlier Hardware Revisions

11.7.1 Failure in 10 MBit/s Half Duplex Mode and Workaround

The note is only valid for the PC cards cifX up to serial numbers indicated:

PC Cars cifX	Part No	up to Serial Number
CIFX 80-RE	1280.100	20034
CIFX 90-RE\F	1290.100	20198
CIFX 90E-RE\F	1291.100	20311
CIFX 104C-RE	1270.100	20137
CIFX 104C-RE-R	1271.100	20029
CIFX 104C-RE\F	1270.101	20197
CIFX 104C-RE-R\F	1271.101	20071



NOTICE

Failure of the Network Communication

- Do not operate hardware with the communication controllers netX 50, netX100 or netX 500 with the protocols Ethernet TCP/UDP/IP, EtherNet/IP or Modbus TCP at 10 MBit/s in half-duplex mode, otherwise failure of the network communication can occur.
- Use only switches or 10/100 MBit/s dual-speed hubs and ensure that the network operates at 100 MBit/s and in full-duplex mode.

USA:

NOTICE

Failure of the Network Communication

- Do not operate hardware with the communication controllers netX 50, netX100 or netX 500 with the protocols Ethernet TCP/UDP/IP, EtherNet/IP or Modbus TCP at 10 MBit/s in half-duplex mode, otherwise failure of the network communication can occur.
- Use only switches or 10/100 MBit/s dual-speed hubs and ensure that the network operates at 100 MBit/s and in full-duplex mode.

Affected Hardware

Hardware with the communication controller netX 50, netX 100 or netX 500; netX/Internal PHYs.

When can this Failure occur?

When using standard Ethernet communication with 10 MBit/s half duplex mode, the PHY gets stuck in case of network collisions. Then no further network communication is possible. Only device power cycling allows Ethernet communication again.

This problem can only occur with Ethernet TCP/UDP IP, EtherNet/IP or Modbus TCP protocols when using hubs at 10 MBit/s. The issue described above is not applicable for protocols which use 100 MBit/s or full duplex mode.

Solution / Workaround:

Do not use 10 MBit/s-only hubs. Use either switches or 10/100 MBit/s Dual Speed hubs, to make sure the netX Ethernet ports are connected with 100 MBit/s or in full duplex mode.

This erratum is fixed with all components of the 'Y' charge (9 digit charge number shows 'Y' at position 5 (nnnnYnnnn)).

Reference

"Summary of 10BT problem on EthernetPHY",
RenesasElectronics Europe, April 27, 2010

11.7.2 Pin Assignment for Mini PCI Express Bus / SYNC Connector (Bootstart), X1/X2

The following details refer to the PC cards CIFX 90E-RE\F*, CIFX 90E-DP\F, CIFX 90E-CO\F, CIFX 90E-DN\F of the earlier hardware revisions 5, 6, 7, 8 and A, as well as on the current hardware revision B (without the variants 'NHS', 'ET' or 'MR').

*The SYNC connection is realized via the mini PCI Express bus.

Pin (X1)	Signal	Pin (X2)	Signal
51	(not used)	52	+3.3V
49	(not used)	50	GND
47	(not used)	48	(not used) (beginning from HW Rev. 6)
45	(not used)	46	IO_SYNC0 (not used with fieldbus protocols)
43	(not used)	44	IO_SYNC1 (not used with fieldbus protocols)
41	(not used)	42	Bootstart
39	(not used)	40	GND
37	(not used)	38	USB_D+ (beginning from HW Rev. B disabled – not used)
35	GND	36	USB_D - (beginning from HW Rev. B disabled – not used)
33	PERp0	34	GND
31	PERn0	32	(not used)
29	GND	30	(not used)
27	GND	28	(not used) (beginning from HW Rev. 6)
25	PETp0	26	GND
23	PETn0	24	(not used) (for HW Rev. ,6,7,8' + B)
21	GND	22	PERST#
19	(not used)	20	(not used)
17	(not used)	18	GND
15	GND	16	(not used)
13	REFCLK+	14	(not used)
11	REFCLK-	12	(not used)
9	GND	10	(not used)
7	CLKREQ#	8	(not used)
5	(not used)	6	(not used) (beginning from HW Rev. 6)
3	(not used)	4	GND
1	(not used)	2	3.3V

Table 186: Pin Assignment Mini PCI Express Bus / SYNC Connector, X1/X2

Unless otherwise noted, the pin assignment for Mini PCI Express bus, X1/X2 described in Table 122 corresponds to the bus specification for Mini PCI Express [bus spec 6, Rev. 1.2, Section 3.3].



Note! Note the following characteristics for the pin assignment of the Mini PCI Express Bus, X1/X2, described in Table 122:

- The **Pins 6, 28, 48** and **Pin 24** are '**not used**' (beginning from HW Rev. 6).
- The **Pins 36** and **38** are '**not used**' (beginning from HW Rev. B).
- The pin assignment of the **Pins 42, 44, 46** deviates from the standard specification Mini PCI Express.



For the reference for [bus spec 6] for the bus specification for Mini PCI Express refer to section *References PCI Specifications* on page 264 of this manual.

Pins 6, 28, 48

- **Beginning from Hardware Revision 6:** For the hardware revisions of the PC cards CIFX 90E-RE\F, CIFX 90E-DP\F, CIFX 90E-CO\F and CIFX 90E-DN\F **beginning from Revision 6** the **Pins 6, 28, 48** are **'not used'**, as listed in the *Table 122* on page 158.
- **Hardware Revisions 1 to 5:**



Important! For the hardware revisions **1 to 5** the **pins 6, 28, 48** may not be connected on the main board.

Pin 24

- **Hardware Revisions 6,7,8 + B:** For the hardware revisions **6,7,8 + B** of the PC cards CIFX 90E-RE\F, CIFX 90E-DP\F, CIFX 90E-CO\F and CIFX 90E-DN\F the **Pin 24** is **'not used'**.
- **Hardware Revisions 1 to 5 and A:** For the hardware revisions **1 to 5 and A** the **Pin 24** is used for **+3.3Vaux**, according to the bus specification for Mini PCI Express.

Pin (X2)	Signal	
	for HW Rev. 6,7,8 + B	for HW Rev. 1 to 5 and A
24	(not used)	+3.3Vaux
Usable with main boards according to Mini PCI Express specification [bus spec 6]	rev. <u>1.1</u> , <u>1.2</u> and <u>2.0</u>	rev. <u>1.2</u> and <u>2.0</u>

Table 187: Assignment of the Pin 24 for HW-Rev. 6,7,8 + B or 1 to 5 and A



Note: Due to how **pin 24** is used, the hardware revisions **6,7,8 + B** of the PC cards CIFX 90E-RE\F, CIFX 90E-DP\F, CIFX 90E-CO\F and CIFX 90E-DN\F can be used together with main boards according to any earlier revision as well as to the latest revision of the Mini PCI Express specification.

Pins 36 and 38 (USB Connector)

The USB connector at the Mini PCI Express Bus of the PC cards CIFX 90E-RE\F, CIFX 90E-DP\F, CIFX 90E-CO\F and CIFX 90E-DN\F is directly connected to the CPU of the PC and is not used for external diagnosis.

- **Hardware Revisions 1 to A:** When you start the PC, the operating system recognizes the USB port and asks for a driver.
- **Beginning of Hardware Revision B:** The Pins 36 and 38 are disabled and are **'not used'**. When you start the PC, the operating system does not ask for an USB driver.

Pin 42 (Bootstart) and 44 , 46 (SYNC)

- **Pin 42 (Bootstart):** For all PC cards CIFX 90E-RE\F, CIFX 90E-DP\F, CIFX 90E-CO\F and CIFX 90E-DN\F **pin 42** is used for **Bootstart**.
- **Pins 44 , 46 (SYNC):** For the PC cards CIFX 90E-RE\F depending by the protocol the **SYNC connection** is realized via the **pins 44 and 46** of the mini PCI Express bus. For further information to the SYNC pins (Pin 46, 44) refer to section *SYNC Connector (Pin-Assignment, Hardware/Firmware)* on page 154.

According to the bus specification for Mini PCI Express [bus spec 6] the pins are used to realize the LED status (Pin 42 „WWAN#“, Pin 44 „WLAN#“, Pin 46 „WPAN#“).

11.8 List of Figures

Figure 1: Example 2D Label (mini sticker on the right)	33
Figure 2: Example Barcode Label (EAN 39)	33
Figure 3: CIFS 80-RE*	34
Figure 4: Front Plate CIFS 80-RE	34
Figure 5: CIFS 80-DP	35
Figure 6: Front Plate CIFS 80-RE	35
Figure 7: CIFS 80-CO	36
Figure 8: Front Plate CIFS 80-CO	36
Figure 9: CIFS 80-DN	37
Figure 10: Front Plate CIFS 80-DN	37
Figure 11: Basic Card CIFS 90 for CIFS 90-RE\F* or for CIFS 90-RE\FM12*	38
Figure 12: identical looking basic cards CIFS 90E for variants -RE\F*, -RE\NHS\F*, -RE\ET\F* or for corresponding M12 variants*	38
Figure 13: identical looking basic cards CIFS 90E for variants -RE\MR\F*, -RE\MR\ET\F* or for corresponding M12 variants*	38
Figure 14: Basic Card CIFS 90 for CIFS 90-DP\F, CIFS 90-CO\F, CIFS 90-DN\F, CIFS 90-CC\F	39
Figure 15: identical looking basic Cards CIFS 90E, CIFS 90E\NHS, CIFS 90E\ET (for CIFS 90E-FB\F, CIFS 90E-FB\NHS\F and CIFS 90E-FB\ET\F)	39
Figure 16: identical looking basic Cards CIFS 90E\MR, CIFS 90E\MR\ET (for CIFS 90E-FB\MR\F, or CIFS 90E-FB\MR\ET\F)	39
Figure 17: Basic Card CIFS 90E-2FB\ET for CIFS 90E-2FB\ET\F	40
Figure 18: Basic Card CIFS 90E-2FB\MR\ET for CIFS 90E-2FB\MR\ET\F	40
Figure 19: Reverse Side CIFS 90-XX\F	40
Figure 20: Reverse Side CIFS 90E-XX\F	40
Figure 21: CIFS 104C-RE*	41
Figure 22: CIFS 104C-RE-R*	41
Figure 23: Basic Card for CIFS 104C-RE\F	42
Figure 24: Basic Card for CIFS 104C-RE-R\F	42
Figure 25: CIFS 104C-DP	43
Figure 26: CIFS 104C-DP-R	43
Figure 27: CIFS 104C-CO	44
Figure 28: CIFS 104C-CO-R	44
Figure 29: CIFS 104C-DN	45
Figure 30: CIFS 104C-DN-R	45
Figure 31: Basic Card CIFS 104C-FB\F for CIFS 104C-DP\F, CIFS 104C-CO\F, CIFS 104C-DN\F, CIFS 104C-CC\F	46
Figure 32: Basic Card CIFS 104C-FB-R\F for CIFS 104C-DP-R\F, CIFS 104C-CO-R\F, CIFS 104C-DN-R\F	46
Figure 33: Reverse Side CIFS 104C-XX (all Basic Cards and Variants)	47
Figure 34: Detached Network Interface Ethernet (AIFS-RE)*	48
Figure 35: Front Side and LED Display Detached Network Interface Ethernet (AIFS-RE)	48
Figure 36: Ethernet M12 detached Network Interface (AIFS-RE\M12)	49
Figure 37: Ethernet M12 detached Network Interface (AIFS-RE\M12)	49
Figure 38: PROFIBUS detached Network Interface (AIFS-DP)	50
Figure 39: Front Side and LED Display PROFIBUS detached Network Interface (AIFS-DP)	50
Figure 40: CANopen detached Network Interface (AIFS-CO)	51
Figure 41: Front Side and LED Display detached Network Interface (AIFS-CO)	51
Figure 42: DeviceNet detached Network Interface (AIFS-DN, with counter part)	52
Figure 43: Front Side and LED Display DeviceNet detached Network Interface (AIFS-DN, with counter part)	52
Figure 44: CC-Link detached Network Interface (AIFS-CC)	53
Figure 45: Reverse Side CC-Link detached Network Interface (AIFS-CC) with Matrix Label	53

Figure 46: Front Side and LED Display CC-Link detached Network Interface (AIFX-CC, with counter part)	53
Figure 47: Diagnostic detached Network Interface (AIFX-DIAG)	54
Figure 48: Front Side, LED Display and Reverse Side Diagnostic detached Network Interface (AIFX-DIAG)	54
Figure 49: Requirement for the temporal Behavior of the Supply Voltage for PC cards cifX Mini PCI Express	68
Figure 50: Front Plate Stickers for CIFX 80-RE	80
Figure 51: Insertion angle approx. 25° (example)	83
Figure 52: Press down the basic card with light pressure (max. 2 N) (example)	84
Figure 53: Example: Fastening with locking hooks, guide basic card when snap-in	84
Figure 54: Connecting the detached Network Interface Ethernet (AIFX-RE) to the basic Card CIFX 90E (Example CIFX 90E-RE\F with Cable Connector Ethernet X4)	85
Figure 55: Connecting the CANopen detached Network Interface (AIFX-CO) to the basic Card CIFX 90E (Example)	85
Figure 56: PC Cards cifX Mini PCI Express with 2 Channels: How to connect the detached Network Interfaces to the Basic Card (Example CIFX 90E-2FB\ET)	86
Figure 57: Connecting the Detached Network Interface Ethernet (AIFX-RE) to the Basic Card CIFX 104C-RE\F (Example)	89
Figure 58: Connecting the CANopen detached Network Interface (AIFX-CO) to the Basic Card 104C-FB-R\F (Example)	90
Figure 59: Connecting the Diagnostic detached Network Interface (AIFX-DIAG) to the Basic Card CIFX 104C-FB-R\F (Example)	90
Figure 60: System Overview cifX to update Firmware, Driver and Software	97
Figure 61: Guide basic card when snapping in	101
Figure 62: Remove PC card cifX from Mini PCI system connector	101
Figure 63: Ethernet Pin Assignment at the RJ45 Socket for cifX or AIFX	138
Figure 64: Ethernet Pin Assignment at M12 Socket for AIFX-RE\M12 (D coded)	139
Figure 65: PROFIBUS Interface (DSub female connector, 9 pin), X400	141
Figure 66: CANopen Interface (DSub male connector, 9 pin), X400	141
Figure 67: DeviceNet Interface (CombiCon male Connector, 5 pin), X360	142
Figure 68: CC-Link Interface (CombiCon male Connector, 5 pin)	142
Figure 69: Mini-B USB Connector (5 Pin)	143
Figure 70: Cable Connector Ethernet X4 or X304; 1x20 Pins for CIFX 104C-RE\F, CIFX 104C-RE\F\M12, CIFX 104C-RE-R\F, CIFX 104C-RE-R\F\M12, CIFX 90-RE\F, CIFX 90-RE\F\M12	145
Figure 71: Cable Connector Ethernet X4; 2x10 Pins for CIFX 90E-RE\F, CIFX 90E-RE\F\M12, CIFX 90E-RE\NHS\F, CIFX 90E-RE\NHS\F\M12, CIFX 90E-RE\ET\F, CIFX 90E-RE\ET\F\M12, CIFX 90E-RE\MR\F, CIFX 90E-RE\MR\F\M12 bzw. CIFX 90E-RE\MR\ET\F, CIFX 90E-RE\MR\ET\F\M12	145
Figure 72: Cable Connector Ethernet X1; 1x20 Pins, AIFX-RE	148
Figure 73: Cable Connector Ethernet X2; 1x20 Pins, AIFX-RE\M12	149
Figure 74: Cable Connector LED Signals X3; 1x10 Pins, AIFX-RE\M12	150
Figure 75: Dimensions CIFX 80E-RE	247
Figure 76: Dimensions Front Panel for CIFX 80-RE	247
Figure 77: Dimensions CIFX 80-DP	248
Figure 78: Front Panel for CIFX 80-DP	248
Figure 79: Dimensions CIFX 80-CO	249
Figure 80: Dimensions Front Panel for CIFX 80-CO	249
Figure 81: Dimensions CIFX 80-DN	250
Figure 82: Dimensions Front Panel CIFX 80-DN	250
Figure 83: Dimensions CIFX 90-XX\F and Variants	251
Figure 84: Dimensions CIFX 90E-XX\F and Variants	251
Figure 85: Dimensions CIFX 104C-RE	252
Figure 86: Dimensions CIFX 104C-RE\	253
Figure 87: Dimensions CIFX 104C-DP	254
Figure 88: Dimensions CIFX 104C-CO	255
Figure 89: Dimensions CIFX 104C-DN	256

Figure 90: Dimensions CIFX 104C-FB\F	257
Figure 91: Reverse Side CIFX 104C-XX (all Basic Cards and Variants)	258
Figure 92: Dimensioning Ethernet detached Network Interface (AIFX-RE)	259
Figure 93: Dimensioning Detached Network Interface Ethernet (AIFX-RE\M12)	260
Figure 94: Drawing Panel Cutout Detached Network Interface Ethernet (AIFX-RE\M12)	260
Figure 95: Dimensioning PROFIBUS detached Network Interface (AIFX-DP)	261
Figure 96: Dimensioning CANopen detached Network Interface (AIFX-CO)	261
Figure 97: Dimensioning DeviceNet detached Network Interface (AIFX-DN, with counter part)	262
Figure 98: Dimensioning CC-Link detached Network Interface (AIFX-CC, with counter part)	263
Figure 99: Dimensioning Diagnostic detached Network Interface (AIFX-DIAG)	263

11.9 List of Tables

Table 1: List of Revisions	10
Table 2: PC Cards Compact PCI CIFX 80-XX	12
Table 3: PC Cards PCI-104: CIFX 104C-XX and CIFX 104C-XX-R	12
Table 4: PC Cards Mini PCI CIFX 90-XX\F, CIFX 90-RE\F\M12	14
Table 5: PC Cards Mini PCI Express CIFX 90E-XX\F, CIFX 90E-RE\F\M12	15
Table 6: PC Cards Mini PCI Express CIFX 90E-XX\NHS\F, CIFX 90E-RE\NHS\F\M12	16
Table 7: PC Cards Mini PCI Express CIFX 90E-XX\ET\F, CIFX 90E-XX\ET\F\M12	17
Table 8: PC Cards Mini PCI Express CIFX 90E-XX\MR\F, CIFX 90E-RE\MR\F\M12	18
Table 9: PC Cards Mini PCI Express CIFX 90E-XX\MR\ET\F, CIFX 90E-RE\MR\ET\F\M12	19
Table 10: PC Cards Mini PCI Express (2 Channels) CIFX 90E-2XX\ET\F, CIFX 90E-2XX\XX\ET\F	20
Table 11: PC Cards Mini PCI Express (2 Channels) CIFX 90E-2XX\MR\ET\F, CIFX 90E-2XX\XX\MR\ET\F	21
Table 12: PC Cards PCI-104: CIFX 104C-XX\F, CIFX 104C-XX-R\F, CIFX 104C-RE\F\M12, CIFX 104C-RE-R\F\M12	22
Table 13: Detached Network Interfaces AIFX for PC Cards cifX with Cable Connector	23
Table 14: Device Description Files for PC Cards cifX Real-Time-Ethernet	26
Table 15: Device Description Files for PC Cards cifX Fieldbus	27
Table 16: Reference on Hardware PC Cards cifX	29
Table 17: Reference on Hardware: Basic Cards for PC Cards cifX, detached Network Interfaces AIFX	30
Table 18: Reference on Firmware (for 1 Channel Systems)	31
Table 19: Reference on Firmware (for 2 Channel Systems)	32
Table 20: Reference on Driver and Software	32
Table 21: PC Cards cifX and the Real-Time Ethernet or Fieldbus Systems realizable	55
Table 22: PC Cards cifX with AIFX detached Network Interface	56
Table 23: Slot for the PC Cards cifX Compact PCI, Mini PCI, Mini PCIe, Mini PCIe (2 channel), PCI-104	63
Table 24: Notes on the Card Height - PC Card cifX Mini PCI and Mini PCI Express	64
Table 25: Max. Total Height (D) of the PC Card cifX	64
Table 26: Panel Cutout at the at the Housing Panel of the PC or at the front plate of the PC cabinet	65
Table 27: Required Panel Cutout and Holes for AIFX	66
Table 28: Requirements Power Supply and Host Interface for PC Cards cifX Compact PCI, Mini PCI, Mini PCI Express and PCI-104	67
Table 29: Requirements to operate PC Cards cifX properly	70
Table 30: Firmware Versions for the DMA Mode (for 1 Channel Systems)	71
Table 31: Firmware Versions for the DMA Mode (for 2 Channel Systems)	72
Table 32: Versions Driver and SYCON.net for the DMA Mode	72
Table 33: Steps for the Software and Hardware Installation, the Configuration and for the Diagnosis of a PC Card cifX Compact PCI, Mini PCI, Mini PCI Express and PCI-104 (Master and Slave)	78
Table 34: LED Labeling depending of the loaded Firmware	80
Table 35: How to assign the detached Network Interfaces for 2-Channel Cards cifX Mini PCI Express	86
Table 36: Notes for the Configuration of the Master Device	94
Table 37: Device Names in SYCON.net by Communication Protocol	96
Table 38: Overview LEDs Real-Time Ethernet Systems	104
Table 39: LED Names	104
Table 40: Overview LEDs by Fieldbus System for 1 Channel Devices	105
Table 41: Overview LEDs by Fieldbus System for 2 Channel Devices (only PC Cards cifX Mini PCI Express)	105
Table 42: LED Names	105
Table 43: System Status LED States	106
Table 44: Power On LED States	106
Table 45: LED states for the CC-Link IE Field Basic Slave	107
Table 46: LED state definitions for the CC-Link IE Field Basic Slave protocol	107
Table 47: LED states for the EtherCAT Master protocol	108

Table 48: LED state definitions for the EtherCAT Master protocol	109
Table 49: LED states for the EtherCAT Slave protocol	110
Table 50: LED state definitions for the EtherCAT Slave protocol	110
Table 51: LED states for the EtherNet/IP Scanner protocol	112
Table 52: LED state definitions for the EtherNet/IP Scanner protocol	112
Table 53: LED states for the EtherNet/IP Adapter protocol	114
Table 54: LED state definitions for the EtherNet/IP Adapter protocol	114
Table 55: LED states for the OpenModbusTCP protocol	115
Table 56: LED state definitions for the OpenModbusTCP protocol	115
Table 57: LED states for the POWERLINK Controlled Node protocol	116
Table 58: LED state definitions for the POWERLINK Controlled Node protocol	116
Table 59: PROFINET IO Controller, SYS, COM0 and COM1 LEDs states	117
Table 60: PROFINET IO Controller, Ethernet LEDs states	118
Table 61: PROFINET IO Controller, LEDs states definitions	118
Table 62: LED states for the PROFINET IO-Device protocol	119
Table 63: LED state definitions for the PROFINET IO-Device protocol	119
Table 64: LED states for the Sercos Master protocol	120
Table 65: LED state definitions for the Sercos Master protocol	121
Table 66: LED state definitions for the Sercos Slave protocol	122
Table 67: LED state definitions for the Sercos Slave protocol	123
Table 68: LED-Zustände für das VARAN-Client-Protokoll	124
Table 69: Definitionen der LED-Zustände für das VARAN-Client-Protokoll	124
Table 70: LED states for the PROFIBUS DP Master protocol – 1 Communication Status LED (current Hardware Revision)	125
Table 71: LED state definitions for the PROFIBUS DP Master protocol	125
Table 72: LED states for the PROFIBUS DP Master protocol – 2 Communication Status LEDs (AIFX-DP connected or prior Hardware Revision)	126
Table 73: LED state definitions for the PROFIBUS DP Master protocol	126
Table 74: LED states for the PROFIBUS DP Slave protocol – 1 Communication Status LED (current Hardware Revision)	127
Table 75: LED state definitions for the PROFIBUS DP Slave protocol	127
Table 76: LED states for the PROFIBUS DP Slave protocol – 2 Communication Status LEDs (AIFX-DP connected or prior Hardware Revision)	128
Table 77: LED state definitions for the PROFIBUS DP Slave protocol	128
Table 78: LED states for the PROFIBUS MPI protocol – 1 Communication Status LED	129
Table 79: LED state definitions for the PROFIBUS MPI protocol	129
Table 80: LED states for the PROFIBUS MPI protocol – 2 Communication Status LEDs (AIFX-DP connected)	130
Table 81: LED state definitions for the PROFIBUS MPI protocol	130
Table 82: LED states for the CANopen Master protocol – 1 Communication Status LED (current Hardware Revision)	131
Table 83: LED state definitions for the CANopen Master protocol	131
Table 84: LED states for the CANopen Master protocol – 2 Communication Status LEDs (AIFX-CO connected or prior Hardware Revision)	132
Table 85: LED state definitions for the CANopen Master protocol	132
Table 86: States of the CAN LED for the CANopen Slave protocol – 1 Communication Status LED (current Hardware Revision)	133
Table 87: LED state definitions for the CANopen Slave protocol	133
Table 88: States of the CAN LED for the CANopen Slave protocol – 2 Communication Status LEDs (AIFX-CO connected or prior Hardware Revision)	134
Table 89: LED state definitions for the CANopen Slave protocol	134
Table 90: LED states for the DeviceNet Master protocol	135
Table 91: LED state definitions for the DeviceNet Master protocol	135
Table 92: LED states for the DeviceNet Slave protocol	136
Table 93: LED state definitions for the DeviceNet Slave protocol	136

Table 94: LED states for the CC-Link Slave protocol	137
Table 95: Ethernet Pin Assignment at the RJ45 Socket for cifX or AIFX	138
Table 96: Ethernet Pin Assignment M12 Socket for AIFX-RE\M12	139
Table 97: Ethernet Connection Data	140
Table 98: Use of Hubs and Switches	140
Table 99: PROFIBUS Interface, X400	141
Table 100: CANopen Interface, X400	141
Table 101: DeviceNet Interface, X360	142
Table 102: CC-Link Interface	142
Table 103: Pin Assignment Mini-B USB Connector	143
Table 104: Rotary Switch for PCI-104 Slot Number, S1	143
Table 105: Pin Assignment for Cable Connector Ethernet X4 or X304	145
Table 106: Pin Assignment for Cable Connector Fieldbus X3, X304 or X4	146
Table 107: Pin Assignment for Cable Connector Fieldbus X3 and X4 for 2 Channel Devices	146
Table 108: Pin Assignment for Cable connector DIAG X3 or X303	147
Table 109: Pin Assignment for Cable Connector Ethernet X1, AIFX-RE (Hardware-Rev. 2)	148
Table 110: Pin Assignment for Cable Connector Ethernet X2, AIFX-RE\M12	149
Table 111: Pin Assignment for Cable Connector LED Signals X3, AIFX-RE\M12	150
Table 112: Pin Assignment for Cable Connector fieldbus X1, AIFX-DP (Hardware Rev. 2)	151
Table 113: Pin Assignment for Cable Connector fieldbus X1, AIFX-CO (Hardware Rev. 2)	151
Table 114: Pin Assignment for Cable Connector fieldbus X1, AIFX-DN (Hardware Rev. 3)	152
Table 115: Pin Assignment for Cable Connector fieldbus X1, AIFX-CC (Hardware Rev. 2)	152
Table 116: Cable for connecting the detached Network Interfaces AIFX-RE or AIFX-RE\M12	153
Table 117: Pin Assignment for SYNC Connector, X51	154
Table 118: SYNC Connector: SYNC Signal, Connector, Max. Cable Length	154
Table 119: Meaning of the SYNC Signals for each Protocol	154
Table 120: Pin Assignment at the PCI Bus	156
Table 121: Pin Assignment for Mini PCI Bus, X1	157
Table 122: Pin Assignment Mini PCI Express Bus / SYNC Connector, X1/X2	158
Table 123: Pin Assignment Mini PCI Express Bus, X1/X2 for 2 Channel Devices	160
Table 124: Technical Data CIFX 80-RE	163
Table 125: Technical Data CIFX 80-DP	165
Table 126: Technical Data CIFX 80-CO	166
Table 127: Technical Data CIFX 80-DN	168
Table 128: Technical Data CIFX 90-RE\F, CIFX 90-RE\F\M12	170
Table 129: Technical Data CIFX 90-DP\F	171
Table 130: Technical Data CIFX 90-CO\F	173
Table 131: Technical Data CIFX 90-DN\F	174
Table 132: Technical Data CIFX 90-CC\F	175
Table 133: Technical Data CIFX 90E-RE\F, CIFX 90E-RE\NHS\F, CIFX 90E-RE\ET\F, CIFX 90E-RE\MR\F, CIFX 90E-RE\MR\ET\F and Variants with AIFX-RE\M12	178
Table 134: Technical Data CIFX 90E-DP\F, CIFX 90E-DP\NHS\F, CIFX 90E-DP\ET\F, CIFX 90E-DP\MR\F, CIFX 90E-DP\MR\ET\F	181
Table 135: Technical Data CIFX 90E-CO\F, CIFX 90E-CO\NHS\F, CIFX 90E-CO\ET\F, CIFX 90E-CO\MR\F, CIFX 90E-CO\MR\ET\F	183
Table 136: Technical Data CIFX 90E-DN\F, CIFX 90E-DN\NHS\F, CIFX 90E-DN\ET\F, CIFX 90E-DN\MR\F, CIFX 90E-DN\MR\ET\F	185
Table 137: Technical Data CIFX 90E-CC\NHS\F, CIFX 90E-CC\ET\F, CIFX 90E-CC\MR\ET\F	187
Table 138: Technical Data CIFX 90E-2DP\ET\F, CIFX 90E-2DP\MR\ET\F	189
Table 139: Technical Data CIFX 90E-2DP\CO\ET\F, CIFX 90E-2DP\COMR\ET\F	191
Table 140: Technical Data CIFX 90E-2DP\DN\ET\F, CIFX 90E-2DP\DN\MR\ET\F	194
Table 141: Technical Data CIFX 90E-2CO\ET\F, CIFX 90E-2CO\MR\ET\F	195
Table 142: Technical Data CIFX 90E-2CO\DN\ET\F, CIFX 90E-2CO\DN\MR\ET\F	197
Table 143: Technical Data CIFX 90E-2DN\ET\F, CIFX 90E-2DN\MR\ET\F	199

Table 144: Technical Data CIFX 104C-RE, CIFX 104C-RE-R	202
Table 145: Technical Data CIFX 104C-RE\F, CIFX 104C-RE-R\F, CIFX 104C-RE\F\M12 or CIFX 104C-RE-R\F\M12	204
Table 146: Technical Data CIFX 104C-DP, CIFX 104C-DP-R	206
Table 147: Technical Data CIFX 104C-DP\F, CIFX 104C-DP-R\F	207
Table 148: Technical Data CIFX 104C-CO, CIFX 104C-CO-R	209
Table 149: Technical Data CIFX 104C-CO\F, CIFX 104C-CO-R\F	211
Table 150: Technical Data CIFX 104C-DN, CIFX 104C-DN-R	213
Table 151: Technical Data CIFX104C-DN\F, CIFX 104C-DN-R\F	215
Table 152: Technical Data CIFX104C-CC\F	217
Table 153: Technical Data AIFX-RE	218
Table 154: Technical Data AIFX-RE\M12	219
Table 155: Technical Data AIFX-DP	220
Table 156: Technical Data AIFX-CO	221
Table 157: Technical Data AIFX-DN	222
Table 158: Technical Data AIFX-CC	223
Table 159: Technical Data AIFX-DIAG	224
Table 160: PCI IDs PC Cards cifX on the PCI Bus	225
Table 161: Supported / not supported PCI Bus Commands	225
Table 162: Technical data CC-Link IE Field Basic Slave protocol	226
Table 163: Technical Data EtherCAT Master Protocol	227
Table 164: Technical Data EtherCAT Slave Protocol	228
Table 165: Technical Data EtherNet/IP Scanner Protocol	229
Table 166: Technical Data EtherNet/IP Adapter protocol	230
Table 167: Technical Data Open Modbus/TCP Protocol	231
Table 168: Technical Data POWERLINK Controlled Node Protocol	231
Table 169: Technical Data PROFINET IO Controller Protocol	233
Table 170: Technical Data PROFINET IO-Device protocol	234
Table 171: Technical Data Sercos Master Protocol	235
Table 172: Technical Data Sercos Slave Protocol	236
Table 173: Technical Data VARAN Client Protocol	237
Table 174: Technical Data PROFIBUS DP Master Protocol	238
Table 175: Technical Data PROFIBUS DP Slave Protocol	239
Table 176: Technical Data PROFIBUS-MPI Protocol	240
Table 177: Technical Data CANopen Master Protocol	241
Table 178: Technical Data CANopen Slave Protocol	242
Table 179: Technical Data DeviceNet Master Protocol	243
Table 180: Technical Data DeviceNet Slave Protocol	244
Table 181: Technical Data CC-Link-Slave-Protocol	245
Table 182: References Protocol API Manuals	264
Table 183: References PCI Specifications	264
Table 184: General Signs, Principles, Safety signs	266
Table 185: Signal Words	266
Table 186: Pin Assignment Mini PCI Express Bus / SYNC Connector, X1/X2	275
Table 187: Assignment of the Pin 24 for HW-Rev. 6,7,8 + B or 1 to 5 and A	276

11.10 Glossary

10-Base T

Standard for communication on Ethernet over twisted pair lines with RJ45 connectors and a [Baud rate](#) of 10 MBit/s (according to the IEEE 802.3 specification).

100-Base TX

Standard for communication on Ethernet over unshielded twisted pair lines with RJ45 connectors and a baud rate of 100 MBit/s according to the IEEE 802. specification

AIFX

Assembly InterFace (detached network interface) based on netX

Auto-Crossover

Auto-Crossover is a feature of an interface: An interface with Auto-Crossover capability will automatically detect and correct if the data lines have been exchanged vice versa.

Auto-Negotiation

Auto-Negotiation is a feature of an interface: An interface with Auto-Negotiation will automatically determine a set of correct communication parameters.

Baud rate

Data transmission speed of a communication channel or interface.

Boot loader

Program loading the firmware into the memory of a device in order to be executed.

CC-Link IE Field

Extremely fast Industrial Ethernet communication system developed by Mitsubishi Electric Corporation, Tokyo, Japan, for high data throughput based on Gigabit

CC-Link IE Field Basic

Communication system for Industrial Ethernet designed and developed by Mitsubishi Electric Corporation, Tokyo, Japan, providing CC-Link IE Field with a speed of 100 Mbit/s based on TCP/IP

CC-Link IE Field Basic Master

Station in the CC-Link IE Field Basic network controlling parameters and managing cyclic communication

CC-Link IE Field Basic Slave

Station in the CC-Link IE Field Basic network communicating with a master station

Ch0, Ch1 ...

Within the configuration software SYCON.net the communication channels are named ,Ch0', Ch1'

For the Real-Time-Ethernet devices cifX, comX and netJACK and the Real-Time Ethernet protocols used with it, the following shall apply:

'Ch0' in SYCON.net: Both ports of the Ethernet RJ45 connector CH0 and CH1 are assigned always to channel 0 in SYCON.net.

'Ch1' in SYCON.net: Depending on the firmware channel 1 in SYCON.net can be used as an additional communication channel.

CH0, CH1 (Ch0, Ch1)

Names for the ports of an Ethernet RJ45 socket with two Ethernet channels.

CH0 stands for Ethernet channel 0.

CH1 stands for Ethernet channel 1.

cifX

Communication InterFace based on netX

cifX TCP/IP Server

cifX TCP Server.exe

Program for the remote diagnostics via Ethernet.

Name: **cifX TCP/IP Server for SYCON.net**

User Interface: **TCP/IP Server for cifX**

Coil

A coil is a single bit in the memory that can be accessed using Modbus: read or write access with FC 1, 5, 15. Depending on the used Modbus function code a single coil or several coils lying in succession can be accessed.

CSP

electronic device data sheet, required for each CC-Link device

Device Description File

A file containing configuration information about a device being a part of a network that can be read out by masters for system configuration. Device Description Files use various formats which depend on the communication system.

DHCP

Dynamic Host Configuration Protocol

This is a protocol simplifying the configuration of IP networks by automatically assigning IP addresses.

Discrete Input

A "Discrete Input" (as defined in the Modbus terminology) is a single bit in the memory which can be accessed using Modbus (read with FC 2).

DP

Decentral Periphery

DPM

Dual-Port Memory

EDS

Electronic Data Sheet

EDS file

A special kind of Device Description File used for example by EtherNet/IP.

ET

Extended Temperature Range (Operating Temperature)

PC cards cifX with the addition of "ET" at the end of the part name can be used in an extended operating temperature range. Details to the operating temperature range are given in the technical data to the respective card.

EtherCAT

A communication system for industrial Ethernet designed and developed by Beckhoff Automation GmbH.

Ethernet

A networking technology used both for office and industrial communication via electrical or optical connections. It has been developed and specified by the Intel, DEC and XEROX. It provides data transmission with collision control and allows various protocols. As Ethernet is not necessarily capable for real-time application, various real-time extensions have been developed.

EtherNet/IP

A communication system for industrial Ethernet designed and developed by Rockwell. It partly uses the CIP (Common Industrial Protocol).

EtherNet/IP Scanner

A Scanner exchanges real-time I/O data with Adapters and Scanners. This type of node can respond to connection requests and can also initiate connections on its own.

EtherNet/IP Adapter

An Adapter emulates functions provided by traditional rack-adapter products. This type of node exchanges real-time I/O data with a Scanner Class product. It does not initiate connections on its own.

Ethernet POWERLINK

A communication system for industrial Ethernet designed and developed by B&R. It partly uses CANopen technologies.

FDL

Fieldbus Data Link defines the PROFIBUS communication on layer 2, identical for DP and FMS

Firmware

Software running inside a device providing the basic functionality of this device. It can be updated by a firmware download.

Full duplex

Full duplex denominates a telecommunication system between two communication partners which allows simultaneous communication in both directions is called a full-duplex telecommunication system. At such a system, it will be possible to transmit data even if currently data are received. Full-duplex is the opposite of Half_duplex.

Function code

A function code (FC) is a standardized method to access, i. e. read or write on coils (Bits) or registers via Modbus.

Modbus function codes are elements of Modbus request/reply telegrams.

GSD

Generic Station Description, Device description file

GSD file

A special kind of Device Description File used by PROFIBUS (GSD = Generic Station Description).

GSDML

Generic Station Description Markup Language

XML based device description file.

GSDML file

A special kind of XML-based Device Description File used by PROFINET.

Half duplex

Half duplex denominates a telecommunication system between two communication partners which does not allow simultaneous, but alternating, communication in both directions is called a half-duplex telecommunication system. At such a system, receiving data inhibits the transmission of data. Half-duplex is the opposite of _Full_duplex.

Hub

A network component connecting multiple communication partners with each other. A hub does not provide own intelligence, thus it does not analyze the data traffic and sends received data to all connected communication partners. A hub can be used for setting up a star topology.

Industrial Ethernet

See Real-Time Ethernet

IP

Internet Protocol.

IP belongs to the TCP/IP family of protocols and is defined in RFC791. It is based on layer 3 of the ISO/OSI 7 layer model of networking.

It is a connectionless protocol, i.e. you do not need to open a connection to a computer before sending an IP data packet to it. Therefore IP is not able to guarantee that the IP data packets really arrive at the recipient. On IP level neither the correctness of data nor the consistence and completeness are checked.

IP defines special addressing mechanisms, see IP Address.

IP Address

Address within IP (the Internet Protocol, part of TCP/IP).

An IP address is an address identifying a device or a computer within a network using the IP protocol. IP addresses are defined as a 32 bit number. Usually, for ease of notation the IP address is divided into four 8 bit numbers which are represented in decimal notation and separated by points:

a.b.c.d

where a.b.c.d are each integer values between 0 and 255.

Example: 192.168.30.15

However, not all combinations are allowed, some are reserved for special purposes.

The IP address 0.0.0.0 is defined as invalid.

MAC-ID

MAC = Media Access Control

Definition for Ethernet:

A MAC-ID is on delivery a unique (physical) Ethernet address of the device.

MAC-IDs are defined as a 48 bit number. Usually, for ease of notation the MAC-ID address is divided into six 8 bit numbers which are represented in hexadecimal notation and separated by "minus"-signs (-):

A-B-C-D-E-F

where A-B-C-D-E-F are each integer values between 0 and 255.

Example: 00-02-A2-20-91-18

Definition for DeviceNet: The MAC-ID is the network address of the device. The network address of a device serves to distinguish itself on a DeviceNet fieldbus system from any other device or Slave on this network. This should be a unique number for each device. A valid MAC-ID address is within a range of 0 to 63 and can be re-entered and changed in the MAC-ID box in the Device Configuration Dialog.

Master

Type of device that initiates and controls the communication on the bus

Modbus Data Model

The data model distinguishes four basic types of data areas:

- Discrete Inputs (inputs) = FC 2 (Read)
- coils (outputs) = FC 1, 5, 15 (Write and Read back)
- Input register (input data) = FC 4 (Read)
- Holding register (output data) = FC 3, 6, 16, 23 (Write and Read back).

It should be noted, however, that depending on the device manufacturer and device type:

- the data area in the device may be present or not,
- and two data areas can be combined into one data region. For example, discrete inputs and input registers can be a common data area, which can be accessed with read-FC 2 and FC 4.
- Further FC 1 and FC 3 are used instead of reading back the inputs to read the outputs.

MPI

Multi Point Interface

The MPI is a proprietary interface of the SIMATIC® S7® series of PLCs. It is compatible to PROFIBUS and based on RS-485. It usually works with a transmission rate of 187.5 kBaud.

netX

networX on chip, Hilscher network communication controllers

netX Configuration Tool

The netX Configuration Tool allows users to operate cifX or netX based devices in different networks. Its graphical user interface serves as a configuration tool for the installation, configuration and diagnosis of the devices.

Object Dictionary

An object dictionary is a storage area for device parameter data structures. It is accessed in standardized manner.

Open Modbus/TCP

A communication system for Industrial Ethernet designed and developed by Schneider Automation and maintained by the Modbus-IDA organization based on the Modbus protocols for serial communication.

PCB

Printed Circuit Board, (printed = machine-made) circuit board

PCIe

Abbreviation for PCI Express

PC Card cifX

Communication Interfaces of the cifX product family of Hilscher on the basis of the communication controller netX 100:

for the Real-Time Ethernet systems

- CC-Link IE Field-Basic
- EtherCAT
- EtherNet/IP
- Open Modbus/TCP
- POWERLINK
- PROFINET IO
- Sercos
- VARAN

and for the fieldbus systems

- PROFIBUS DP
- PROFIBUS MPI
- CANopen
- DeviceNet
- CC-Link

as Communication Interface netX with PCI Bus

- PCI (CIFX50),
- PCI Express (CIFX 50E),
- Low Profile PCI Express (CIFX 70E, CIFX 100EH-RE\CUBE*),
- Compact PCI (CIFX 80),
- Mini PCI (CIFX 90),
- Mini PCI Express (CIFX 90E),
- PCI-104 (CIFX 104C)

and as Communication Interface netX with ISA Bus

- PCI-104 (CIFX 104).

*only Real-Time Ethernet

PROFINET

A communication system for Industrial Ethernet designed and developed by PROFIBUS & PROFINET International (PI). It uses some mechanisms similar to those of the PROFIBUS field bus.

PROFINET IO Controller

A PROFINET control unit responsible for the defined run-up of an I/O subsystem and the cyclic or acyclic data exchange.

PROFINET IO Device

A PROFINET field device that cyclically receives output data from its IO-Controller and responds with its input data.

RE

RE stands for Real-Time Ethernet

Real-Time Ethernet

Real-Time Ethernet (Industrial Ethernet) is an extension of the Ethernet networking technology for industrial purposes with very good real-time features and performance. There is a variety of different Real-Time Ethernet systems on the market which are incompatible with each other. The most important systems of these are

- CC-Link IE Field-Basic
- EtherCAT
- EtherNet/IP
- Ethernet POWERLINK
- Open Modbus/TCP
- PROFINET
- Sercos
- VARAN

Register

A register is a 16-bit wide storage area for data which can be accessed and addressed as a unit by some of the Modbus Function Codes.

Depending on the used Modbus function code a single register or multiple registers sequentially located can be accessed.

Modbus differs Input Registers (FC 4) and Holding Registers (FC 3, 6, 16, 23).

Remanent

Remanent memory holds its data even after power-off, for instance flash memory is remanent. It is also called non-volatile memory.

RJ45

A connector type often used for Ethernet connection. It has been standardized by the Federal Communications Commission of the USA (FCC).

Sercos

A communication system for industrial Ethernet designed and developed by Bosch-Rexroth and supported by Sercos International.

Slave

Type of device that is configured by the Master and which then performs the communication

Switch

A network component connecting multiple communication partners (or even entire branches of a network) with each other. A switch is an intelligent network component which analyzes network traffic in order to decide on its own. For the connected communication partners a switch behaves transparently.

SYNC

Synchronization cycle of the master

SYCON.net

FDT/DTM based configuration and diagnosis software by Hilscher

TCP/IP

Transport Control Protocol/Internet Protocol connection-orientated, secure transfer protocol as basis for the Internet-protocols

UCMM

Unconnected Message Manager

VARAN

Versatile **A**utomation **R**andom **A**ccess **N**etwork

A communication system for industrial Ethernet based on the DIAS-BUS developed by Sigmatek. The system is supported by the VARAN-BUS-NUTZERORGANISATION (VNO).

Watchdog Timer

A watchdog timer provides an internal supervision mechanism of a communication system. It supervises that an important event happens within a given timeframe (the watchdog time which can be adjusted accordingly, for instance by a parameter in the warmstart message) and causes an alarm otherwise (usually this is accomplished by changing the operational state of the communication system to a more safe state).

X1, X2, X3, X4 ...

serve as position names on the circuit board but can also have other or extended meanings

X1, X2

correspond for PC cards cifX Mini PCI Express to the Hilscher convention for „interface“ on the top or the bottom side

X3, X4

(names on the circuit board) ... serve for PC cards cifX Mini PCI Express with 2 channels to identify the respective communication channel:
X3 stands for fieldbus 1 (channel X3; in SYCON.net assigned to *Ch0*).
X4 stands for fieldbus 2 (channel X4; in SYCON.net assigned to *Ch1*).

XDD file

A special kind of Device Description file used by Ethernet POWERLINK.

XML

XML means Extended Markup Language. It is a symbolic language for structuring data systematically. XML is standard maintained by the W3C (World-wide web consortium). Device Description Files often use XML-based formats for storing the device-related data appropriately.

11.11 Contacts

Headquarters

Germany

Hilscher Gesellschaft für Systemautomation mbH
Rheinstraße 15
D-65795 Hattersheim
Phone: +49 (0) 6190 9907-0
Fax: +49 (0) 6190 9907-50
E-mail: info@hilscher.com

Support

Phone: +49 (0) 6190 9907-990
E-mail: hotline@hilscher.com

Subsidiaries

China

Hilscher Systemautomation (Shanghai) Co. Ltd.
200010 Shanghai
Phone: +86 (0) 21-6355-5161
E-mail: info@hilscher.cn

Support

Phone: +86 (0) 21-6355-5161
E-mail: cn.support@hilscher.com

France

Hilscher France S.a.r.l.
69800 Saint Priest
Phone: +33 (0) 4 72 37 98 40
E-mail: info@hilscher.fr

Support

Phone: +33 (0) 4 72 37 98 40
E-mail: fr.support@hilscher.com

India

Hilscher India Pvt. Ltd.
Pune, Delhi, Mumbai, Bangalore
Phone: +91 8888 750 777
E-mail: info@hilscher.in

Support

Phone: +91 8108884011
E-mail: info@hilscher.in

Italy

Hilscher Italia S.r.l.
20090 Vimodrone (MI)
Phone: +39 02 25007068
E-mail: info@hilscher.it

Support

Phone: +39 02 25007068
E-mail: it.support@hilscher.com

Japan

Hilscher Japan KK
Tokyo, 160-0022
Phone: +81 (0) 3-5362-0521
E-mail: info@hilscher.jp

Support

Phone: +81 (0) 3-5362-0521
E-mail: jp.support@hilscher.com

Republic of Korea

Hilscher Korea Inc.
13494, Seongnam, Gyeonggi
Phone: +82 (0) 31-739-8361
E-mail: info@hilscher.kr

Support

Phone: +82 (0) 31-739-8363
E-mail: kr.support@hilscher.com

Austria

Hilscher Austria GmbH
4020 Linz
Phone: +43 732 931 675-0
E-mail: sales.at@hilscher.com

Support

Phone: +43 732 931 675-0
E-mail: at.support@hilscher.com

Switzerland

Hilscher Swiss GmbH
4500 Solothurn
Phone: +41 (0) 32 623 6633
E-mail: info@hilscher.ch

Support

Phone: +41 (0) 32 623 6633
E-mail: support.swiss@hilscher.com

USA

Hilscher North America, Inc.
Lisle, IL 60532
Phone: +1 630-505-5301
E-mail: info@hilscher.us

Support

Phone: +1 630-505-5301
E-mail: us.support@hilscher.com